

# PCMflash module 71

Bosch MEDC17 Bootloader

## Contents/Оглавление

Contents/Оглавление.....	2
MED17.0 TC1767 .....	7
MEDG17.0 TC1797 .....	8
MED17.0.1 TC1767.....	9
MED17.1 TC1796 .....	10
MED17.1.1 TC1797.....	11
MED17.1.6 TC1797.....	12
MED17.1.10 TC1793.....	13
MED17.1.21 TC1793.....	14
MED17.1.27 TC1793.....	15
MED17.1.61 TC1793.....	16
MED17.1.62 TC1793.....	17
ME17.2 TC1797.....	18
MED17.2 TC1796.....	19
MEV17.2 TC1796 .....	20
MEVD17.2 TC1797.....	21
ME(V)17.2.1 TC1796.....	22
MEV17.2.2 TC1767 .....	23
MEVD17.2.2 TC1797 .....	24
MEVD17.2.3 TC1793 .....	25
ME17.2.4 TC1793 .....	26
MEVD17.2.4 TC1797 .....	27
MEVD17.2.5 TC1797 .....	28
MEVD17.2.6 TC1797 .....	29
MEVD17.2.7 TC1797 .....	30
MEVD17.2.8/17.2.9 TC1797.....	31
MEVD17.2.G TC1797.....	32
MEVD17.2.H TC1797.....	33
ME17.3 TC1724.....	34
MED17.3.1 TC1766.....	35
MED17.3.4 TC1797.....	36
MED17.3.5 TC1793.....	37
MED/MEV17.4 TC1766.....	38
MED/MEV(D)17.4.2 TC1767.....	39

MED17.4.4 TC1793.....	40
MEVD17.4.4 TC1793 .....	41
ME(V)17.4.5 TC1796.....	42
MEV17.4.6 TC1796.....	43
ME17.5 TC1766.....	44
MED17.5 TC1766 .....	45
MED17.5.1 TC1796.....	46
MED17.5.2 TC1767.....	47
MED17.5.5 TC1766.....	48
ME17.5.6 TC1767 .....	49
MED17.5.20 TC1766.....	50
MED17.5.21 TC1782.....	51
MED17.5.25 TC1782.....	52
ME17.5.26 TC1724 .....	53
ME17.7 TC1796.....	54
MED17.7.1 TC1797.....	55
MED17.7.2 TC1797.....	56
MED17.7.3 TC1797.....	57
MED17.7.3.1 TC1797 .....	58
MED17.7.5 TC1793.....	59
MED17.7.7 TC1793.....	60
MED17.8.2 TC1767.....	61
MEVD17.8.4 TC1797 .....	62
ME17.8.5 TC1762 .....	63
M17.8.7 TC1762.....	64
ME17.8.8/ME17.8.8.1/ME17U6 TC1728/TC1782 .....	65
MED17.8.10 TC1728/TC1782.....	66
MED17.8.21 TC1767.....	67
MED17.8.31 TC1797.....	68
ME17.8.32 TC1797 .....	69
MED17.8.32 TC1793.....	70
MED17.8.34 TC1793.....	71
MEDC17.9 TC1793.....	72
MEG17.9.2 TC1767.....	73
MED17.9.3 TC1793.....	74
ME17.9.6 TC1767 .....	75

ME17.9.7 TC1762 .....	76
MED17.9.7 TC1767 .....	77
ME(D)17.9.8 TC1767 .....	78
MEG17.9.8 TC1767 .....	79
MEDG17.9.8 TC1767 .....	80
MED17.9.9 TC1793 .....	81
ME17.9.11 TC1762 .....	82
MEG17.9.12/17.9.13 TC1762 .....	83
ME17.9.20 TC1782 .....	84
MEG17.9.21 TC1724 .....	85
ME17.9.21.1 TC1724 .....	86
MED17.9.30 TC1793 .....	87
ME17.9.51 TC1762 .....	88
ME17.9.52 TC1782 .....	89
ME17.9.55 TC1724 .....	90
ME17.9.61 TC1724 .....	91
MED17.9.63 TC1793 .....	92
ME17.9.64 TC1724 .....	93
ME17.9.71 TC1724 .....	94
ME17.9.74 TC1762 .....	95
EDC17C06 TC1766 .....	96
EDC17C08 TC1766 .....	97
EDC17C10 TC1797 .....	98
EDC17C11 TC1766 .....	99
EDC17C18 TC1766 .....	100
EDC17C19 TC1792 .....	101
EDC17C41 TC1797 .....	102
EDC17C42 TC1767 .....	103
EDC17C43 TC1797 .....	104
EDC17C45 TC1767 .....	105
EDC17C46 TC1767 .....	106
EDC17C47 TC1782 .....	107
EDC17C49 TC1797 .....	108
EDC17C50 TC1797 .....	109
EDC17C53 TC1767 .....	110
EDC17C54 TC1797 .....	111



EDC17C56 TC1797 .....	112
EDC17C57 TC1793 .....	113
EDC17C58 TC1793 .....	114
EDC17C59 TC1767 .....	115
EDC17C60 TC1793 .....	116
EDC17C63 TC1724 .....	117
EDC17C64 TC1797 .....	118
EDC17C66 TC1793 .....	119
EDC17C69 TC1793 .....	120
EDC17C70 TC1793 .....	121
EDC17C73 TC1793 .....	122
EDC17C74 TC1793 .....	123
EDC17C76 TC1793 .....	124
EDC17C79 TC1797 .....	125
EDC17C81 TC1782 .....	126
EDC17C83 TC1793 .....	127
EDC17C84 TC1782 .....	128
EDC17CP01 TC1796 .....	129
EDC17CP02 TC1766 .....	130
EDC17CP04 TC1796 .....	131
EDC17CP05 TC1796/TC1797 .....	132
EDC17CP06 TC1796 .....	133
EDC17CP07 TC1766 .....	134
EDC17CP09 TC1796 .....	135
EDC17CP10 TC1796 .....	136
EDC17CP11 TC1796 .....	137
EDC17CP14 TC1796 .....	138
EDC17CP15 TC1796 .....	139
EDC17CP16 TC1797 .....	140
EDC17CP18 TC1796 .....	141
EDC17CP19 TC1792 .....	142
EDC17CP20 TC1796 .....	143
EDC17CP21 TC1792 .....	144
EDC17CP22 TC1796 .....	145
EDC17CP24 TC1796 .....	146
EDC17CP27 TC1796 .....	147

EDC17CP37 TC1766 .....	148
EDC17CP42 TC1797 .....	149
EDC17CP44 TC1797 .....	150
EDC17CP45 TC1797 .....	151
EDC17CP46 TC1797 .....	152
EDC17CP47 TC1797 .....	153
EDC17CP48 TC1797 .....	154
EDC17CP49 TC1797 .....	155
EDC17CP50 TC1797 .....	156
EDC17CP52 TC1797 .....	157
EDC17CP54 AMAROK TC1793 .....	158
EDC17CP54 AUDI TC1793.....	159
EDC17CP55 TC1793 .....	160
EDC17CP57 TC1793 .....	161
EDC17CP58 TC1767 .....	162
EDC17CP60 TC1793 .....	163
EDC17CP62 TC1793 .....	164
EDC17CP65 TC1793 .....	165
EDC17CP68 TC1797 .....	166
EDC17CP74 TC1793 .....	167
EDC17CV41 TC1797.....	168
EDC17CV42 TC1797 .....	170
EDC17CV43/CV44 TC1767 .....	171
EDC17CV52 TC1797 .....	172
EDC17CV53/CV54/CV56 TC1767 .....	173
EDC17U01 TC1766 .....	174
EDC17U05 TC1766 .....	175
DCU17CV51 TC1724.....	176
DCU17HD01 TC1766.....	177
DCU17PC01 TC1766.....	178
DCU17PC42/PC43 TC1724 .....	179

# PCMflash

Engine Control Unit

## MED17.0 TC1767

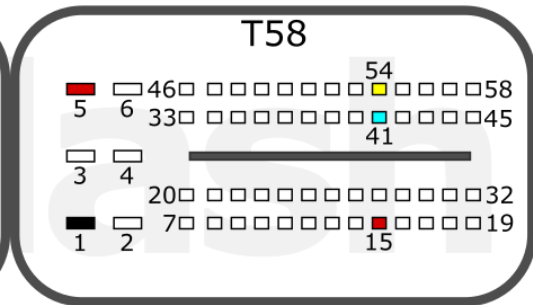
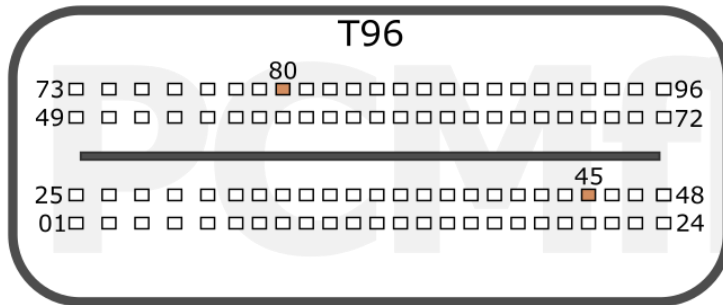

<b>+12V</b>	T58: 5, 15	<b>CAN-L</b>	T58: 41
<b>GND</b>	T58: 1	<b>CAN-H</b>	T58: 54
<b>GPT</b>	T96: 80, 45		

FORD

VOLVO

pcmflash.ru

v.2

2022-06-08

# PCMflash

Engine Control Unit

## MEDG17.0 TC1797

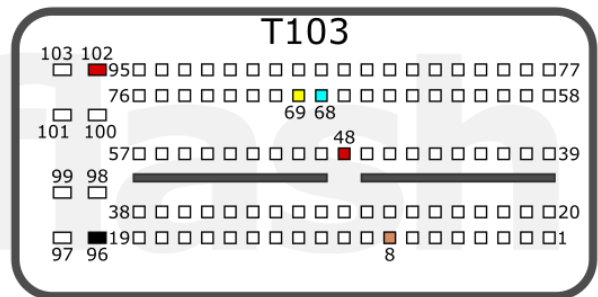
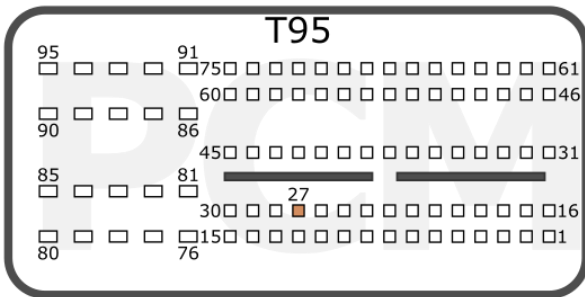

<b>+12V</b>	T103: 102, 48	<b>CAN-L</b>	T103: 68
<b>GND</b>	T103: 96	<b>CAN-H</b>	T103: 69
<b>GPT</b>	T103:8, T95: 27		

FORD

pcmflash.ru

v.1

2021-09-30

# PCMflash

Engine Control Unit

## MED17.0.1 TC1767

### Connection version 1

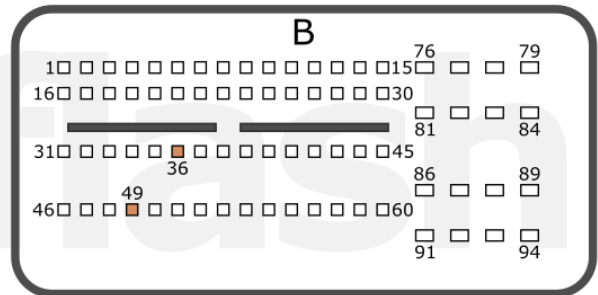
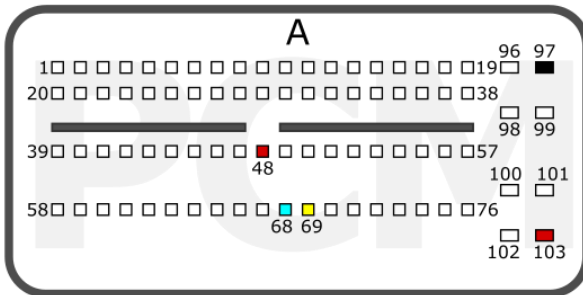

<b>+12V</b>	A: 48, 103	<b>CAN-L</b>	A: 68
<b>GND</b>	A: 97	<b>CAN-H</b>	A: 69
<b>GPT</b>	B: 36, 49		

### Connection version 2

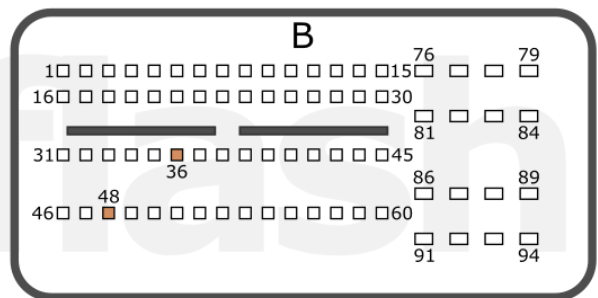
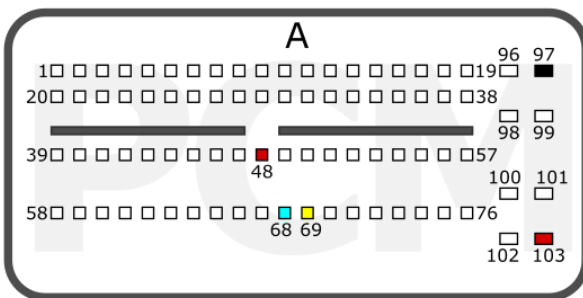

<b>+12V</b>	A: 48, 103	<b>CAN-L</b>	A: 68
<b>GND</b>	A: 97	<b>CAN-H</b>	A: 69
<b>GPT</b>	B: 36, 48		

FORD



# PCMflash

Engine Control Unit

## MED17.1.1 TC1797

### AUDI

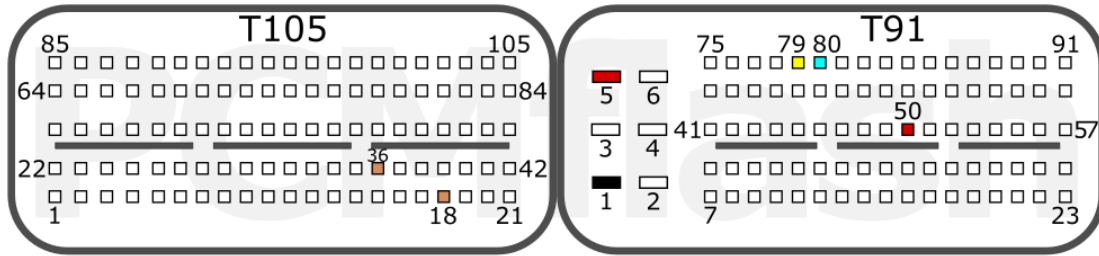

<b>+12V</b>	T91: 5, 50	<b>CAN-L</b>	T91: 80
<b>GND</b>	T91: 1	<b>CAN-H</b>	T91: 79
<b>GPT</b>	T105: 18, 36		

### VOLKSWAGEN

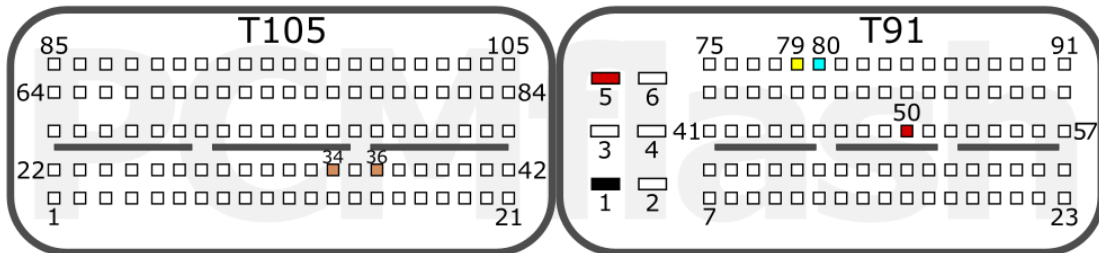

<b>+12V</b>	T91: 5, 50	<b>CAN-L</b>	T91: 80
<b>GND</b>	T91: 1	<b>CAN-H</b>	T91: 79
<b>GPT</b>	T105: 34, 36		

### VAG

# PCMflash

Engine Control Unit

## MED17.1.6 TC1797

### VAG

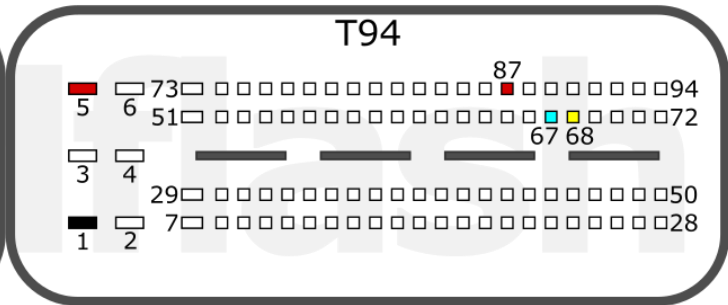
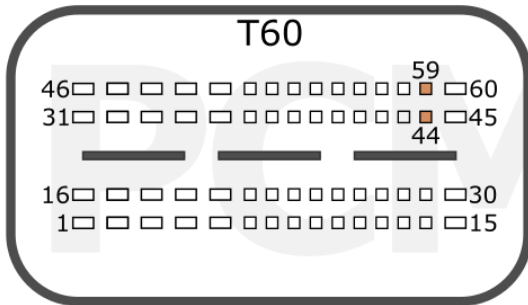

<b>+12V</b>	T94: 5, 87	<b>CAN-L</b>	T94: 67
<b>GND</b>	T94: 1	<b>CAN-H</b>	T94: 68
<b>GPT</b>	T60: 44, 59		

### PORSCHE

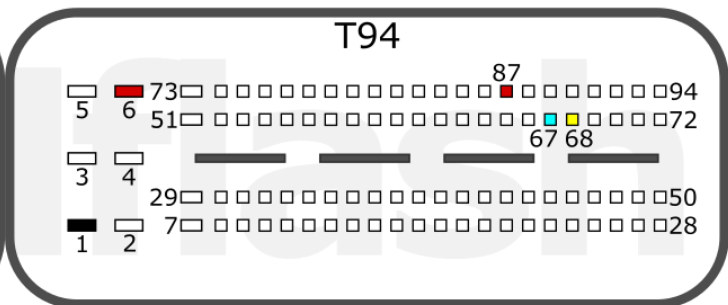
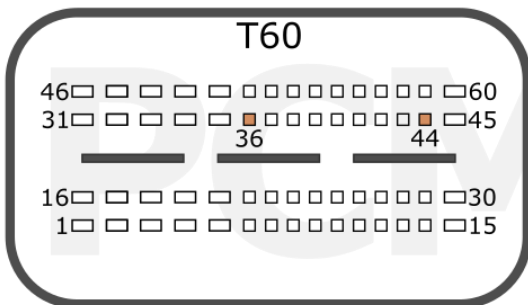

<b>+12V</b>	T94: 6, 87	<b>CAN-L</b>	T94: 67
<b>GND</b>	T94: 1	<b>CAN-H</b>	T94: 68
<b>GPT</b>	T60: 44, 36		

PORSCHE

VAG

pcmflash.ru

v.1

2021-09-11



# PCMflash

Engine Control Unit

## MED17.1.10 TC1793

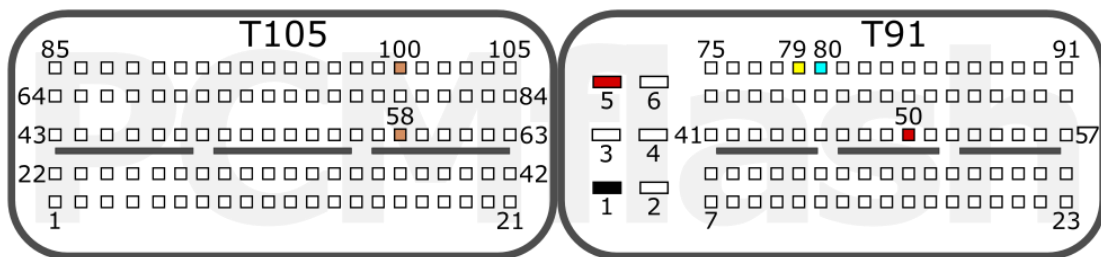

<b>+12V</b>	T91: 5, 50	<b>CAN-L</b>	T91: 80
<b>GND</b>	T91: 1	<b>CAN-H</b>	T91: 79
<b>GPT</b>	T105: 100, 58		

AUDI

pcmflash.ru

v.1

2021-09-11

# PCMflash

Engine Control Unit

## MED17.1.21 TC1793

### Connection version 1

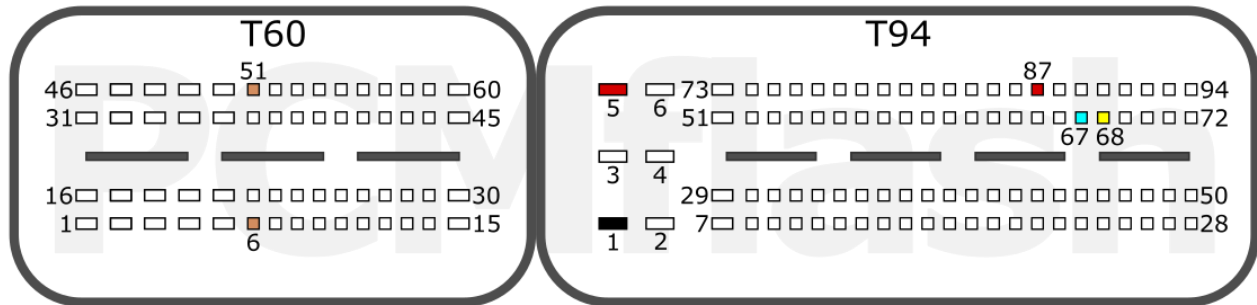

<b>+12V</b>	T94: 5, 87	<b>CAN-L</b>	T94: 67
<b>GND</b>	T94: 1	<b>CAN-H</b>	T94: 68
<b>GPT</b>	T60: 51, 6		

### Connection version 2

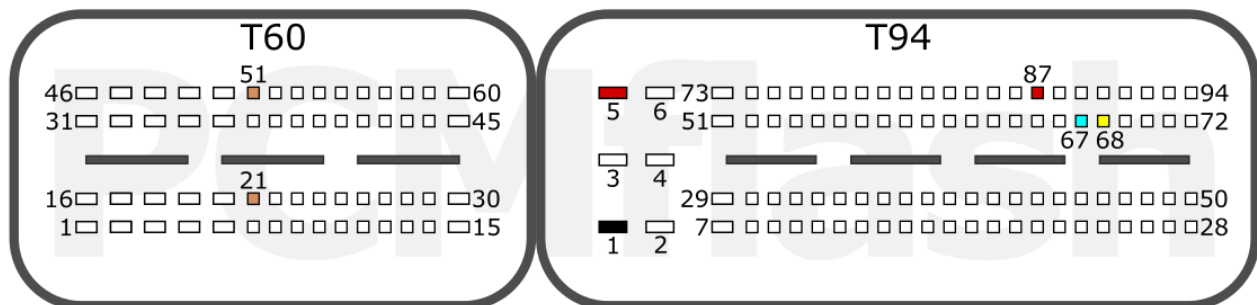

<b>+12V</b>	T94: 5, 87	<b>CAN-L</b>	T94: 67
<b>GND</b>	T94: 1	<b>CAN-H</b>	T94: 68
<b>GPT</b>	T60: 21, 51		

VAG

pcmflash.ru

v.1

2021-10-14



# PCMflash

Engine Control Unit

## MED17.1.61 TC1793

### AUDI

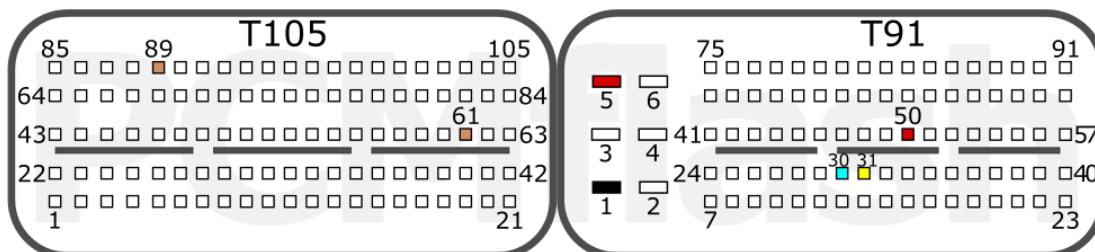

<b>+12V</b>	T91: 5, 50	<b>CAN-L</b>	T91: 30
<b>GND</b>	T91: 1	<b>CAN-H</b>	T91: 31
<b>GPT</b>	T105: 61, 89		

VAG

pcmflash.ru

v.1

2023-10-01

# PCMflash

Engine Control Unit

## MED17.1.62 TC1793

### VOLKSWAGEN

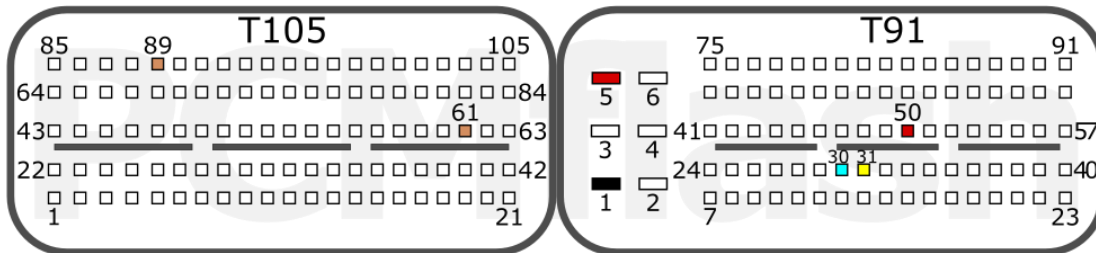

<b>+12V</b>	T91: 5, 50	<b>CAN-L</b>	T91: 30
<b>GND</b>	T91: 1	<b>CAN-H</b>	T91: 31
<b>GPT</b>	T105: 61, 89		

### AUDI

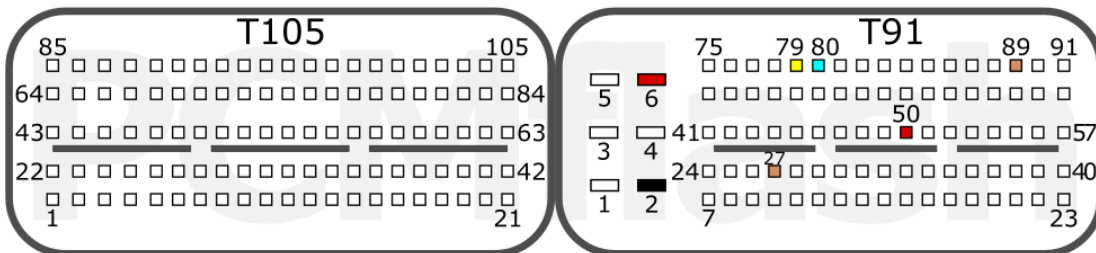

<b>+12V</b>	T91: 6, 50	<b>CAN-L</b>	T91: 80
<b>GND</b>	T91: 2	<b>CAN-H</b>	T91: 79
<b>GPT</b>	T105: 27, 89		

### VAG



# PCMflash

Engine Control Unit

## MED17.2 TC1796

### Connection version 1

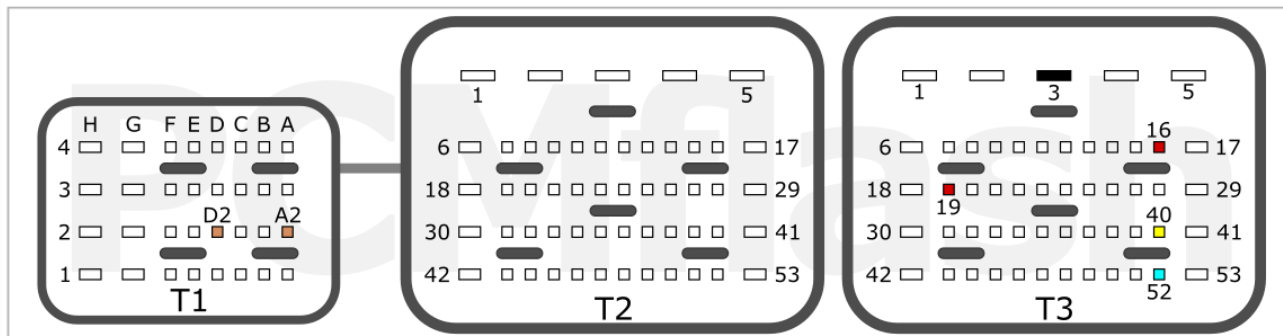

<b>+12V</b>	T3: 16, 19	<b>CAN-L</b>	T3: 52
<b>GND</b>	T3: 3	<b>CAN-H</b>	T3: 40
<b>GPT</b>	T1: A2, D2		

### Connection version 2

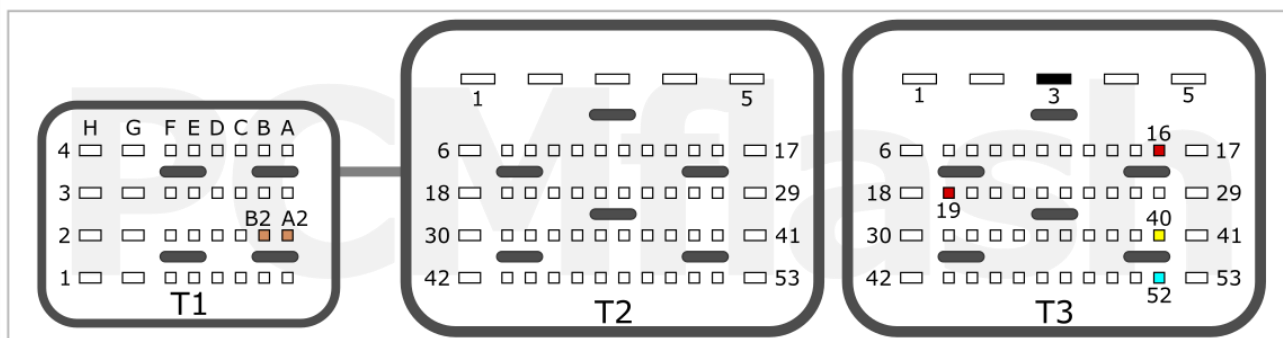

<b>+12V</b>	T3: 16, 19	<b>CAN-L</b>	T3: 52
<b>GND</b>	T3: 3	<b>CAN-H</b>	T3: 40
<b>GPT</b>	T1: B2, A2		

MINI

pcmflash.ru

v.1

2021-11-01

# PCMflash

Engine Control Unit

## MEV17.2 TC1796

### TYPE 1



<b>+12V</b>	T58: 1, 7	<b>CAN-L</b>	T58: 33
<b>GND</b>	T58: 6	<b>CAN-H</b>	T58: 46
<b>GPT</b>	T96: 22, 23		

### TYPE 2

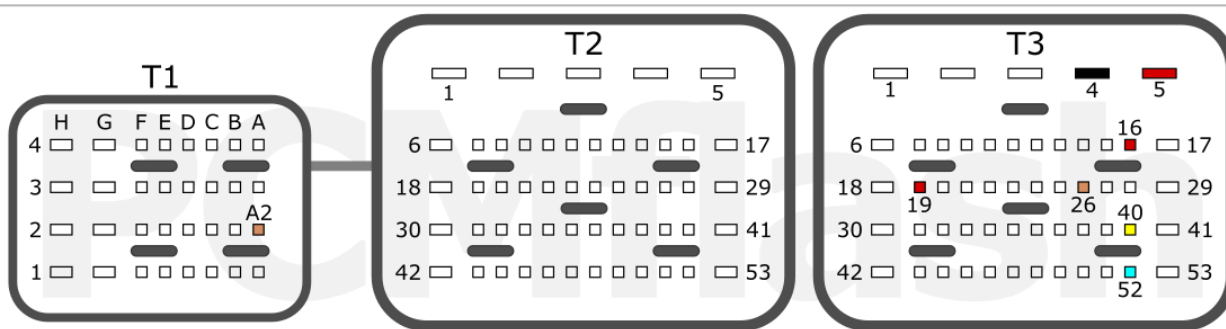

<b>+12V</b>	T3: 5, 16, 19	<b>CAN-L</b>	T3: 52
<b>GND</b>	T3: 4	<b>CAN-H</b>	T3: 40
<b>GPT</b>	T1: A2, T3: 26		

BMW



# PCMflash

Engine Control Unit

## MEVD17.2 TC1797

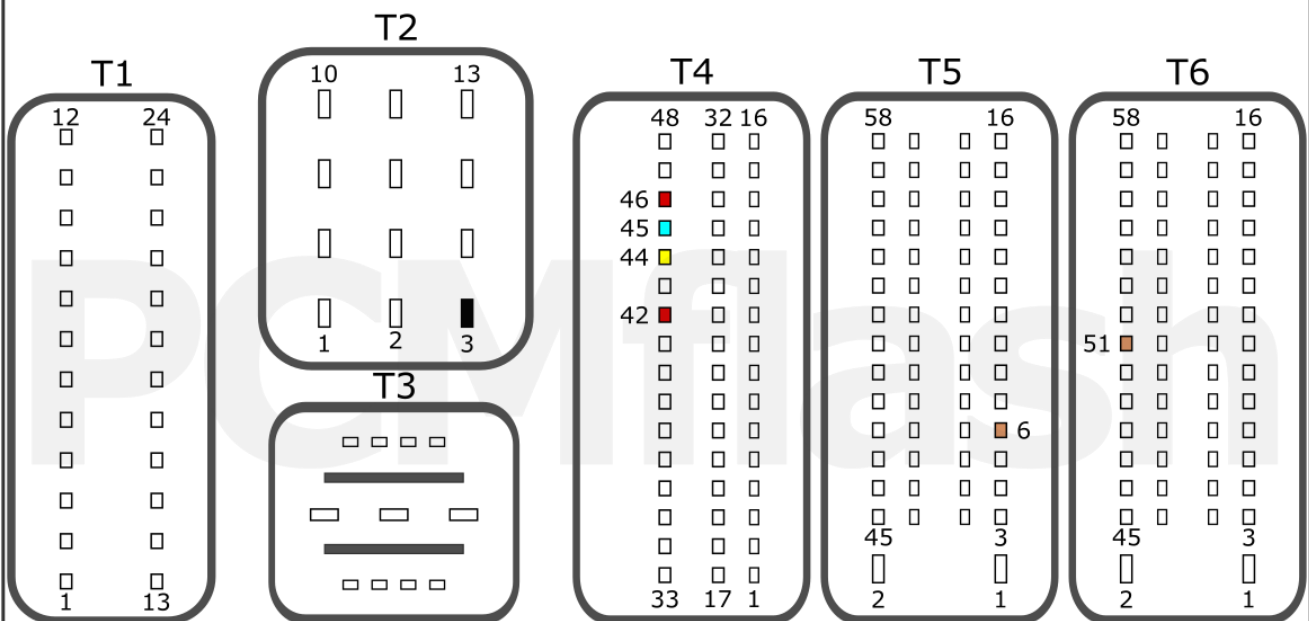

<b>+12V</b>	T4: 42, 46	<b>CAN-L</b>	T4: 45
<b>GND</b>	T2: 3	<b>CAN-H</b>	T4: 44
<b>GPT</b>	T6: 51, T5: 6		

BMW

pcmflash.ru

v.1

2021-09-04

# PCMflash

Engine Control Unit

ME(V)17.2.1 TC1796

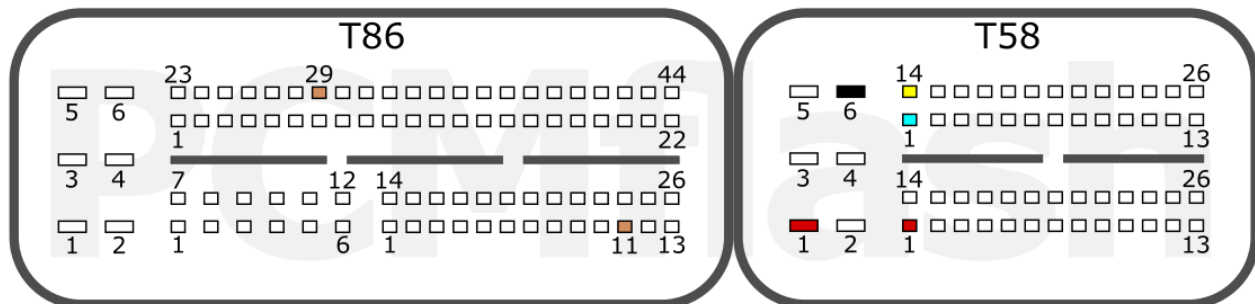

<b>+12V</b>	T58: 1, 1	<b>CAN-L</b>	T58: 1
<b>GND</b>	T58: 6	<b>CAN-H</b>	T58: 14
<b>GPT</b>	T86: 29, 11		

BMW

pcmflash.ru

v.2

2021-12-14

# PCMflash

Engine Control Unit

MEV17.2.2 TC1767

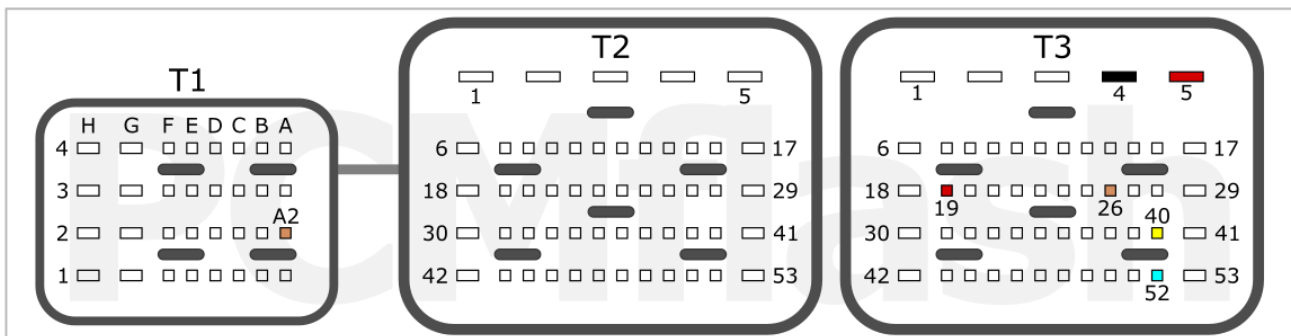

<b>+12V</b>	T3: 5, 19	<b>CAN-L</b>	T3: 52
<b>GND</b>	T3: 4	<b>CAN-H</b>	T3: 40
<b>GPT</b>	T1: A2, T3:26		

BMW

pcmflash.ru

v.1

2021-10-10

# PCMflash

Engine Control Unit

## MEVD17.2.2 TC1797

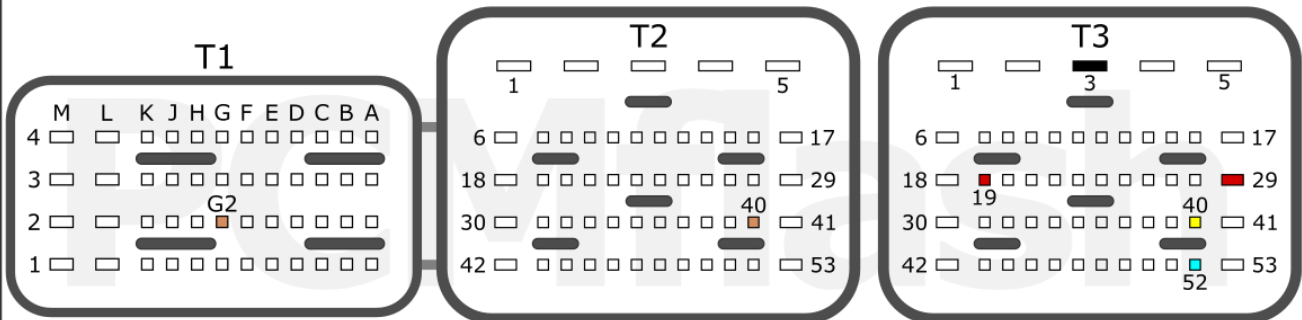

<b>+12V</b>	T3: 19, 29	<b>CAN-L</b>	T3: 52
<b>GND</b>	T3: 3	<b>CAN-H</b>	T3: 40
<b>GPT</b>	T2: 40, T1: G2		

MINI

pcmflash.ru

v.1

2021-10-22

# PCMflash

Engine Control Unit

## MEVD17.2.3 TC1793

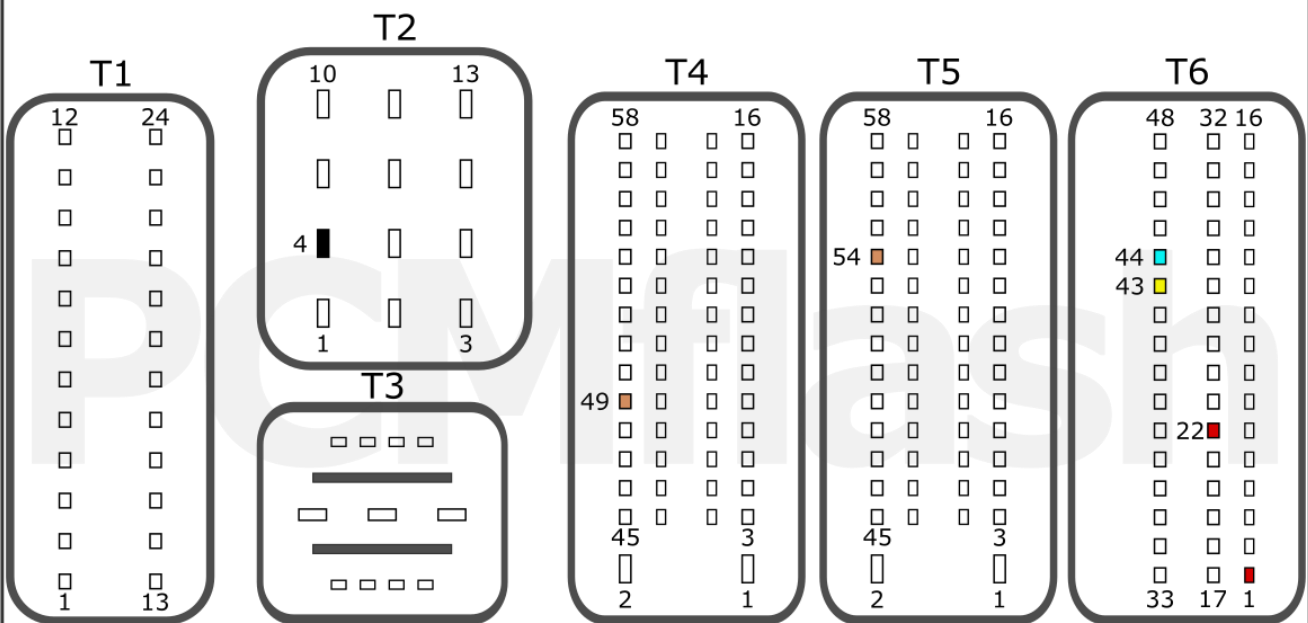

<b>+12V</b>	T6: 22, 1	<b>CAN-L</b>	T6: 44
<b>GND</b>	T2: 4	<b>CAN-H</b>	T6: 43
<b>GPT</b>	T5: 54, T4: 49		

BMW

pcmflash.ru

v.1

2021-08-24



# PCMflash

Engine Control Unit

MEVD17.2.4 TC1797

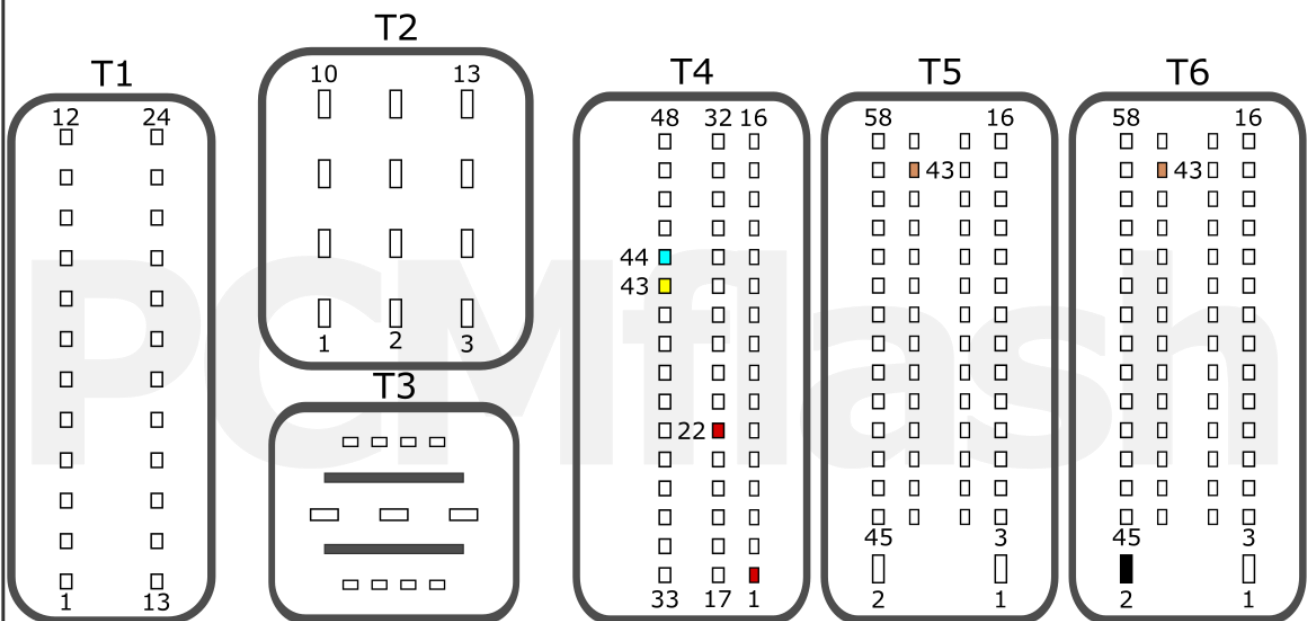

<b>+12V</b>	T4: 1, 22	<b>CAN-L</b>	T4: 44
<b>GND</b>	T6: 2	<b>CAN-H</b>	T4: 43
<b>GPT</b>	T5: 43, T6: 43		

BMW

pcmflash.ru

v.1

2021-09-16

# PCMflash

Engine Control Unit

## MEVD17.2.5 TC1797

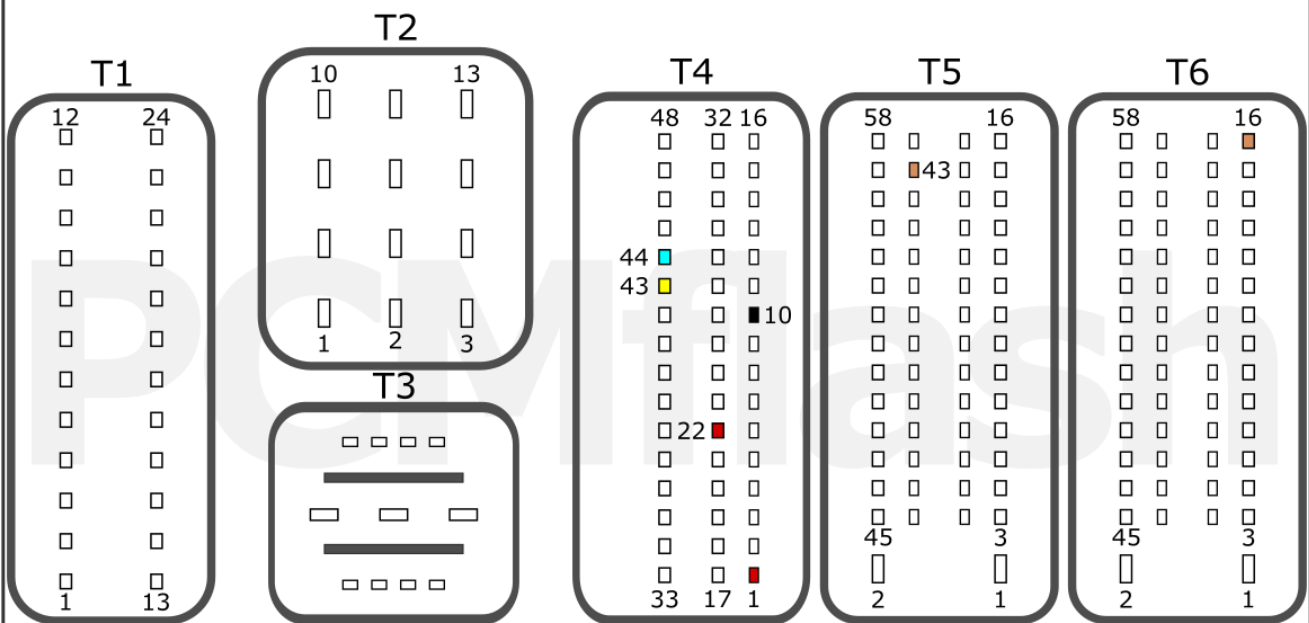

<b>+12V</b>	T4: 22, 1	<b>CAN-L</b>	T4: 44
<b>GND</b>	T4: 10	<b>CAN-H</b>	T4: 43
<b>GPT</b>	T6: 16, T5: 43		

BMW

pcmflash.ru

v.1

2021-10-11



# PCMflash

Engine Control Unit

## MEVD17.2.6 TC1797

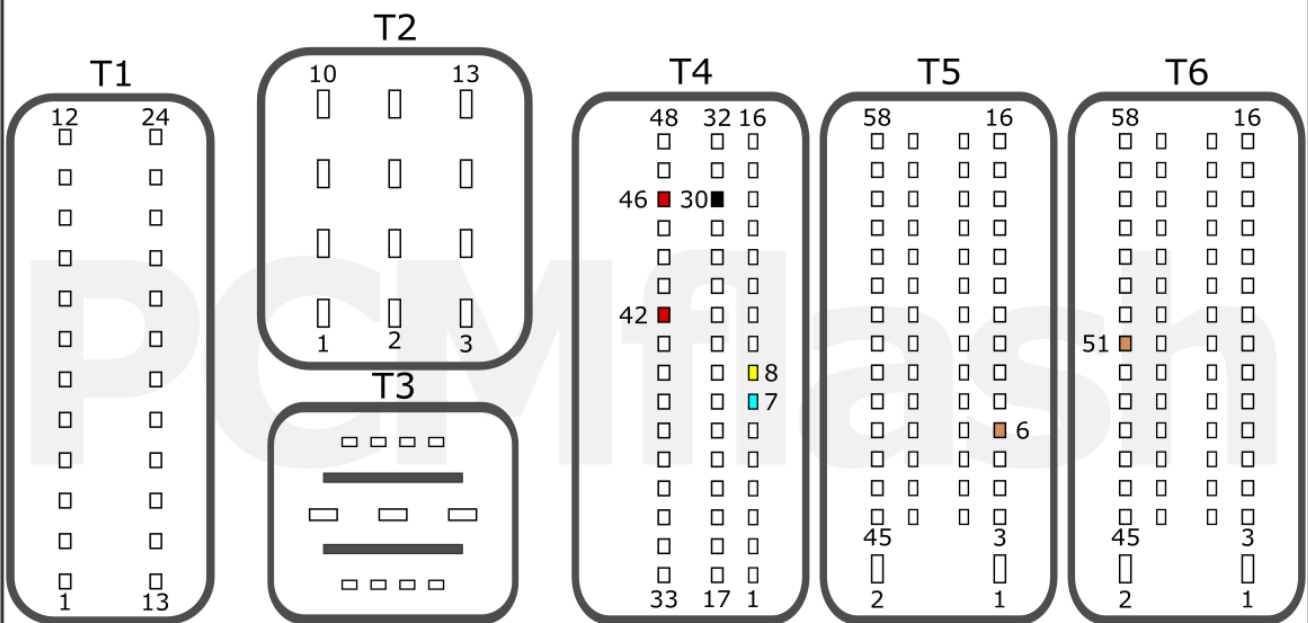

<b>+12V</b>	T4: 42, 46	<b>CAN-L</b>	T4: 7
<b>GND</b>	T4: 30	<b>CAN-H</b>	T4: 8
<b>GPT</b>	T5: 6, T6: 51		

BMW

pcmflash.ru

v.1

2021-08-29

# PCMflash

Engine Control Unit

## MEVD17.2.7 TC1797

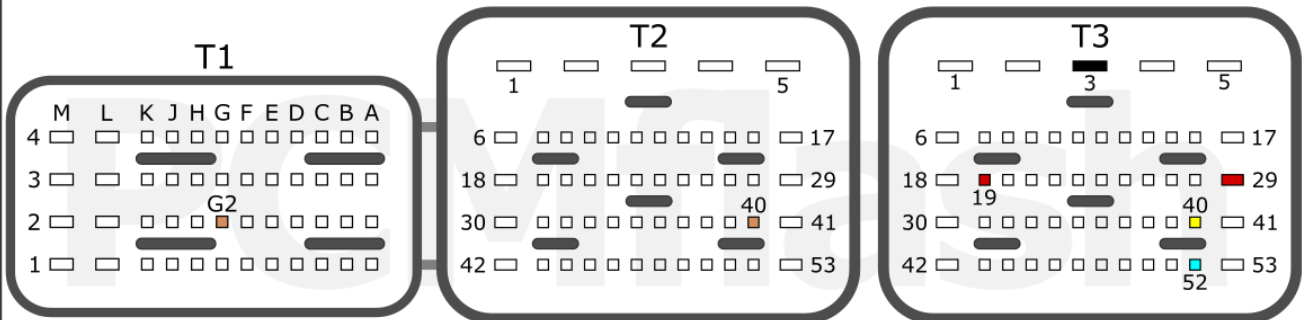

<b>+12V</b>	T3: 19, 29	<b>CAN-L</b>	T3: 52
<b>GND</b>	T3: 3	<b>CAN-H</b>	T3: 40
<b>GPT</b>	T2: 40, T1: G2		

MINI

pcmflash.ru

v.1

2021-10-12

# PCMflash

Engine Control Unit

MEVD17.2.8/17.2.9 TC1797

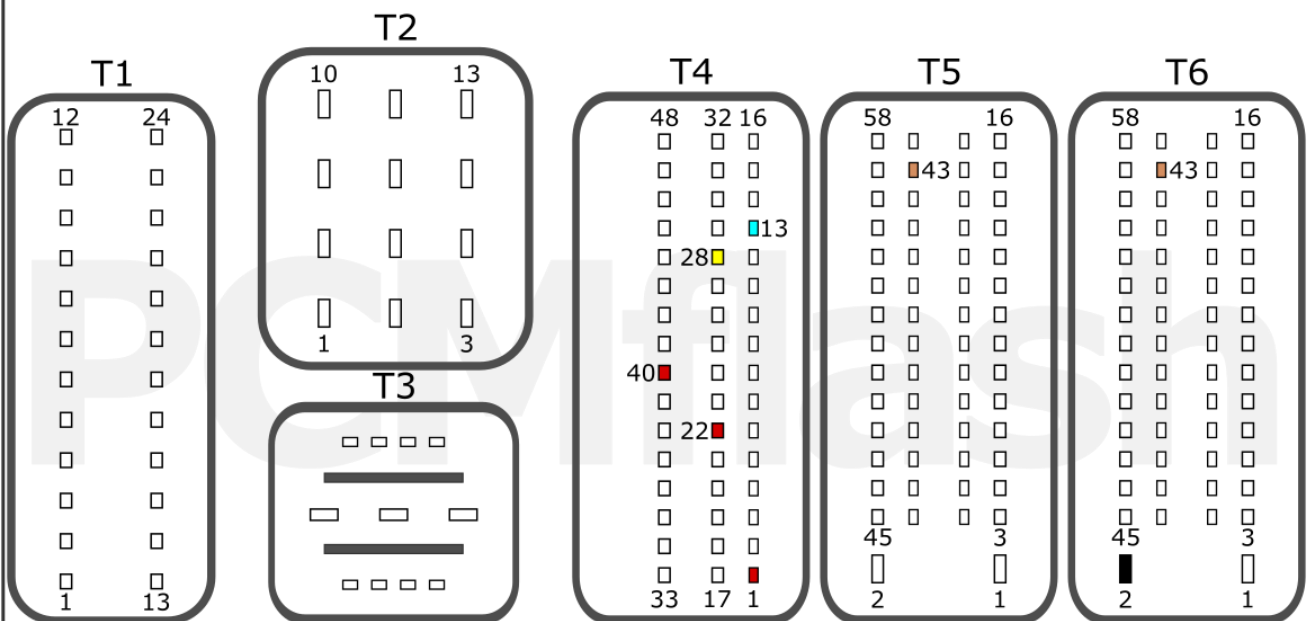

<b>+12V</b>	T4: 40, 22, 1	<b>CAN-L</b>	T4: 13
<b>GND</b>	T6: 2	<b>CAN-H</b>	T4: 28
<b>GPT</b>	T6: 43, T5: 43		

BMW

pcmflash.ru

v.2

2022-01-24

# PCMflash

Engine Control Unit

MEVD17.2.G TC1797

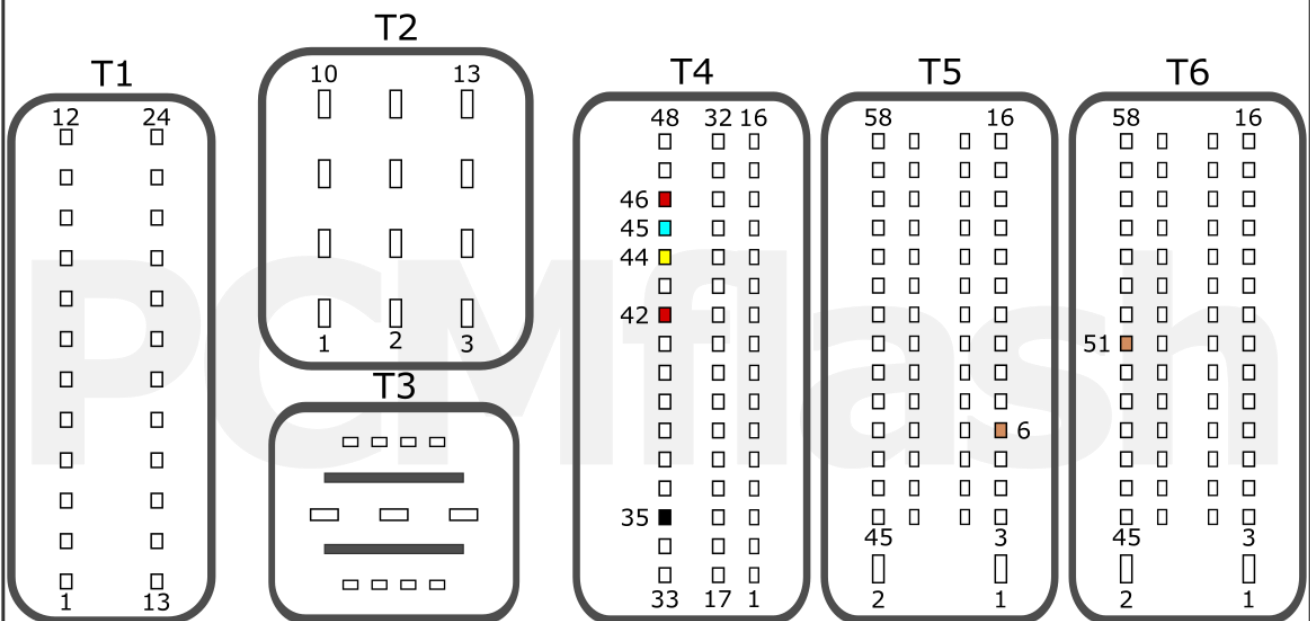

<b>+12V</b>	T4: 42, 46	<b>CAN-L</b>	T4: 45
<b>GND</b>	T4: 35	<b>CAN-H</b>	T4: 44
<b>GPT</b>	T6: 51, T5: 6		

BMW

pcmflash.ru

v.1

2021-10-08

# PCMflash

Engine Control Unit

## MEVD17.2.H TC1797

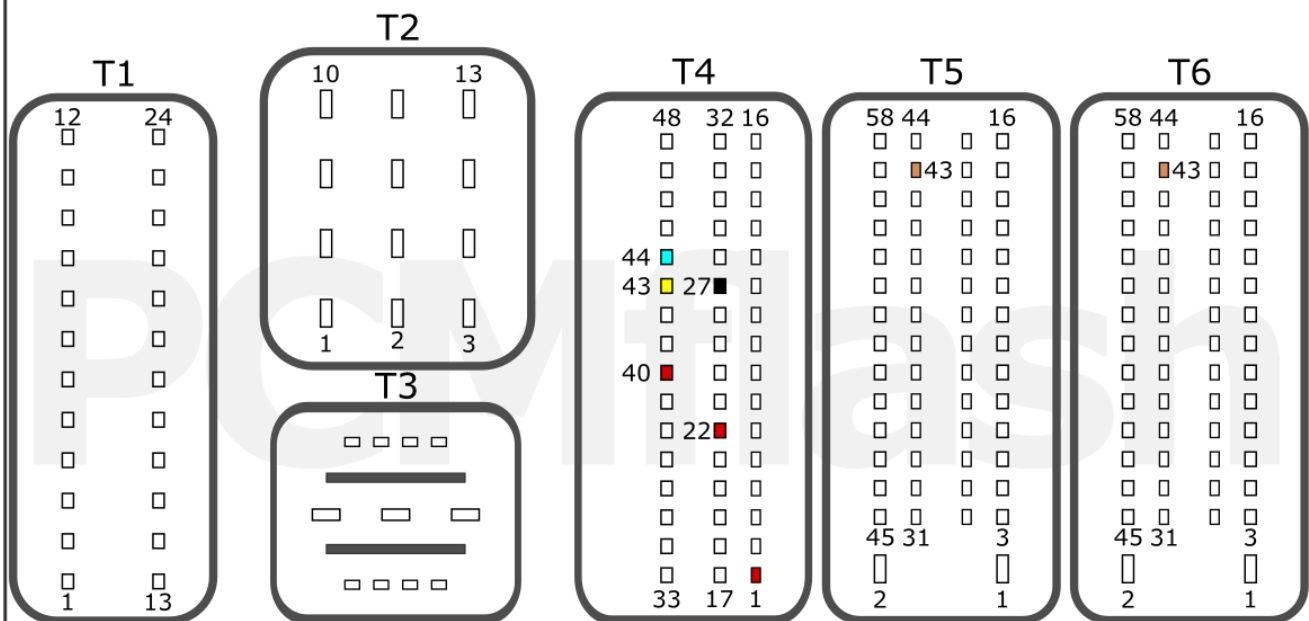

<b>+12V</b>	T4: 1, 22, 40	<b>CAN-L</b>	T4: 44
<b>GND</b>	T4: 27	<b>CAN-H</b>	T4: 43
<b>GPT</b>	T5: 43, T6: 43		

BMW

pcmflash.ru

v.1

2021-10-31

# PCMflash

Engine Control Unit

## ME17.3 TC1724

### FIAT

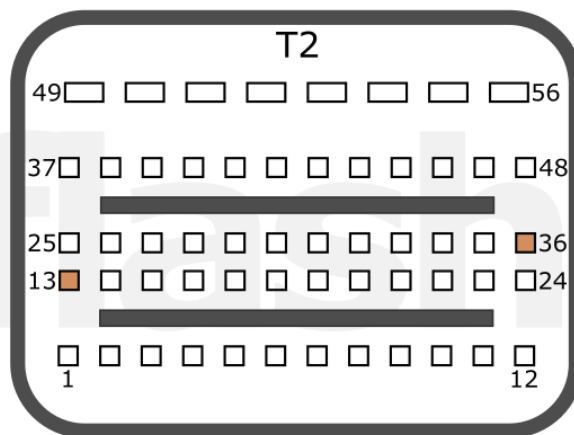
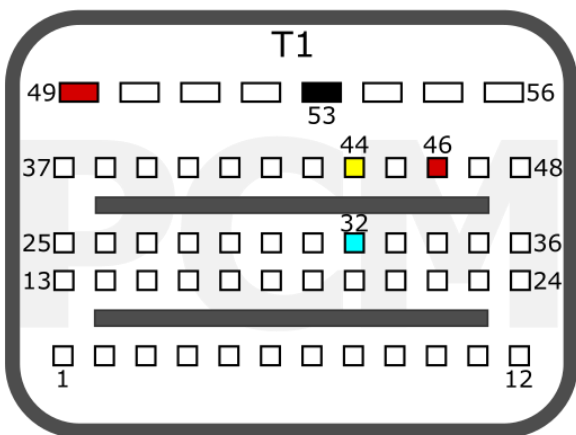

<b>+12V</b>	T1: 49, 46	<b>CAN-L</b>	T1: 32
<b>GND</b>	T1: 53	<b>CAN-H</b>	T1: 44
<b>GPT</b>	T2: 36, 13		

### OPEL

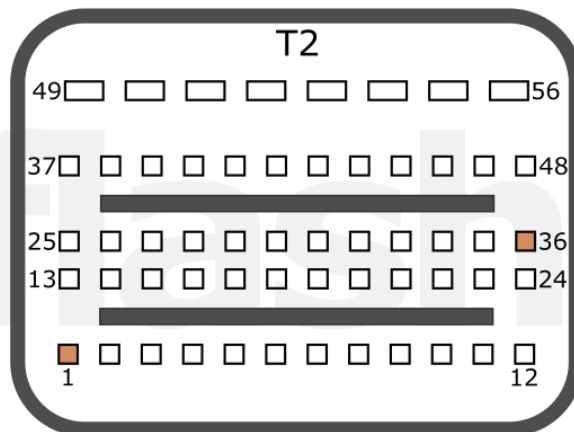
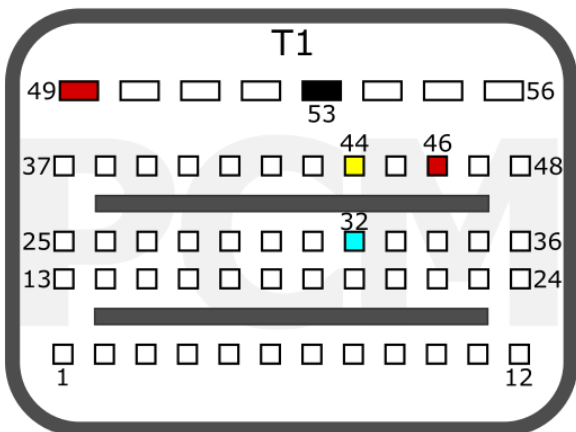

<b>+12V</b>	T1: 49, 46	<b>CAN-L</b>	T1: 32
<b>GND</b>	T1: 53	<b>CAN-H</b>	T1: 44
<b>GPT</b>	T2: 36, 1		

FIAT

OPEL

pcmflash.ru

v.1

2021-10-31



# PCMflash

Engine Control Unit

## MED17.3.4 TC1797

T105

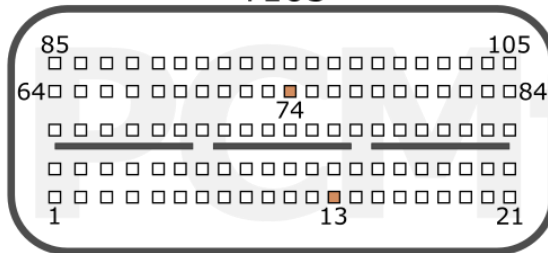

T91

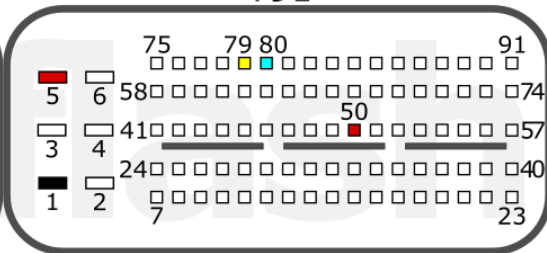

<b>+12V</b>	T91: 5, 50	<b>CAN-L</b>	T91: 80
<b>GND</b>	T91: 1	<b>CAN-H</b>	T91: 79
<b>GPT</b>	T105: 13, 74		

MASERATI

pcmflash.ru

v.1

2021-10-11



# PCMflash

Engine Control Unit

## MED17.3.5 TC1793

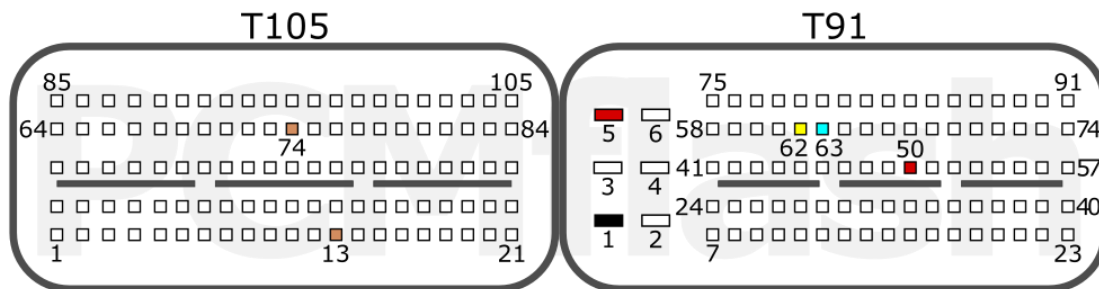

<b>+12V</b>	T91: 5, 50	<b>CAN-L</b>	T91: 63
<b>GND</b>	T91: 1	<b>CAN-H</b>	T91: 62
<b>GPT</b>	T105: 74, 13		

FERRARI

pcmflash.ru

v.1

2021-12-03

# PCMflash

Engine Control Unit  
MED/MEV17.4 TC1766

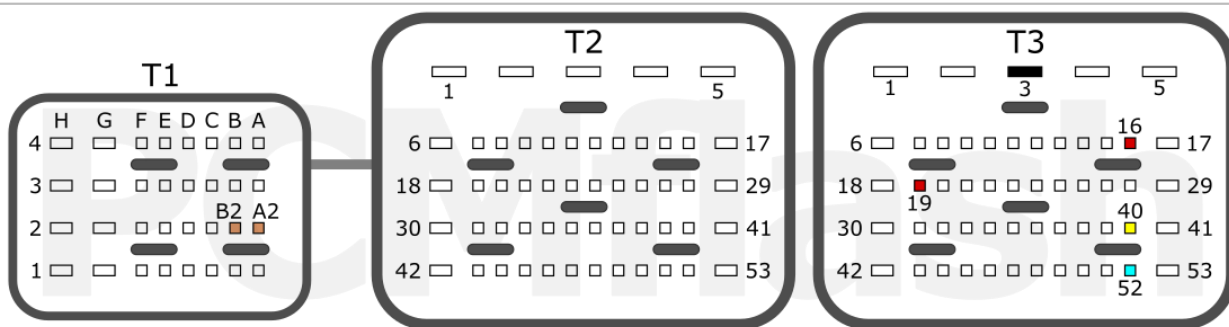

<b>+12V</b>	T3: 16, 19	<b>CAN-L</b>	T3: 52
<b>GND</b>	T3: 3	<b>CAN-H</b>	T3: 40
<b>GPT</b>	T1: A2, B2		

PSA

pcmflash.ru

v.2

2021-12-14

# PCMflash

Engine Control Unit

MED/MEV(D)17.4.2 TC1767

## Connection version 1

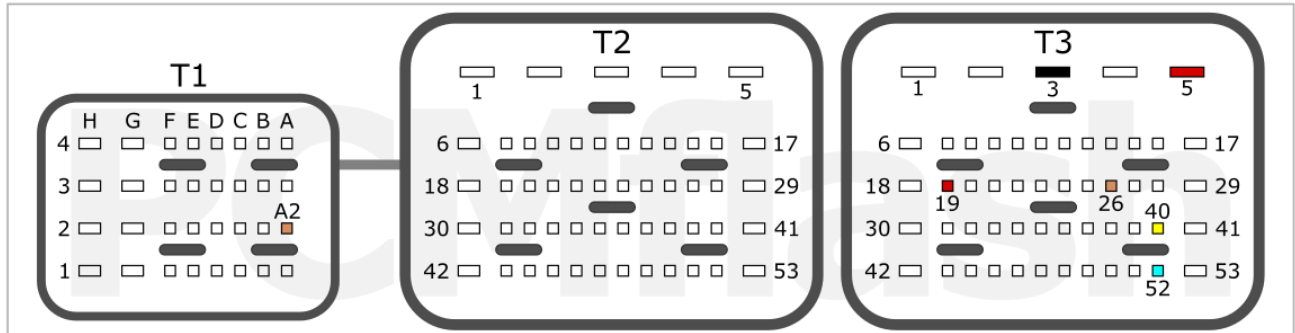

<b>+12V</b>	T3: 5, 19	<b>CAN-L</b>	T3: 52
<b>GND</b>	T3: 3	<b>CAN-H</b>	T3: 40
<b>GPT</b>	T1: A2, T3: 26		

## Connection version 2

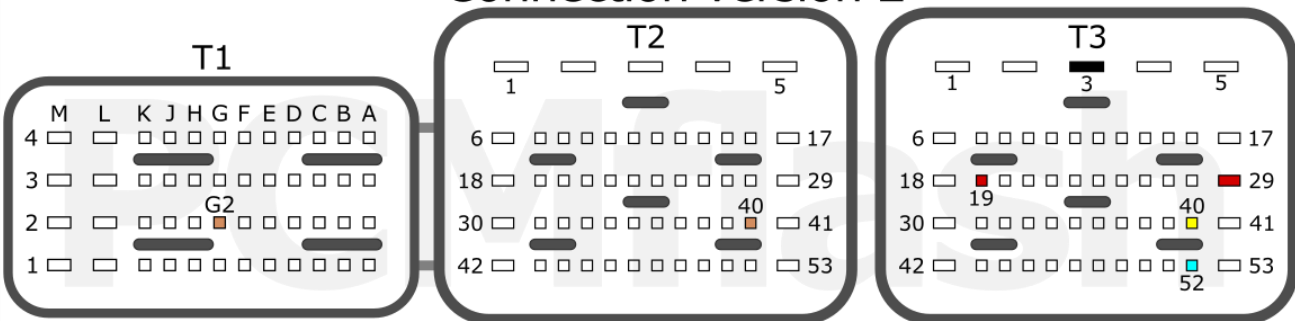

<b>+12V</b>	T3: 19, 29	<b>CAN-L</b>	T3: 52
<b>GND</b>	T3: 3	<b>CAN-H</b>	T3: 40
<b>GPT</b>	T2: 40, T1: G2		

## Connection version 3

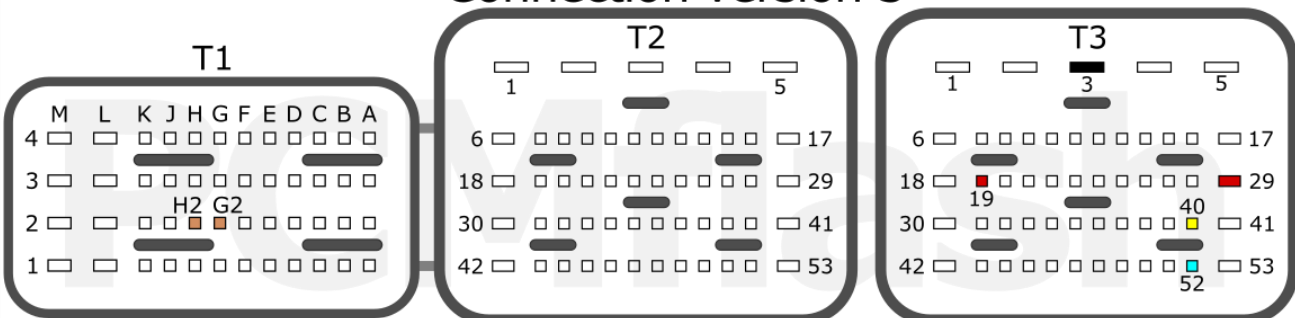

<b>+12V</b>	T3: 19, 29	<b>CAN-L</b>	T3: 52
<b>GND</b>	T3: 3	<b>CAN-H</b>	T3: 40
<b>GPT</b>	T1: H2; T1:G2		

PSA

pcmflash.ru

v.3

2024.04.10

# PCMflash

Engine Control Unit

## MED17.4.4 TC1793

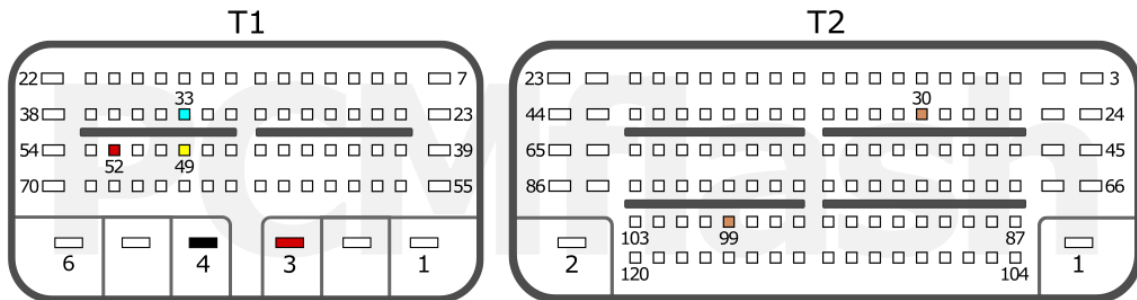

<b>+12V</b>	T1: 52, 3	<b>CAN-L</b>	T1: 33
<b>GND</b>	T1: 4	<b>CAN-H</b>	T1: 49
<b>GPT</b>	T2: 99, 30		

CITROEN

pcmflash.ru

v.1

2021-10-06

# PCMflash

Engine Control Unit

MEVD17.4.4 TC1793

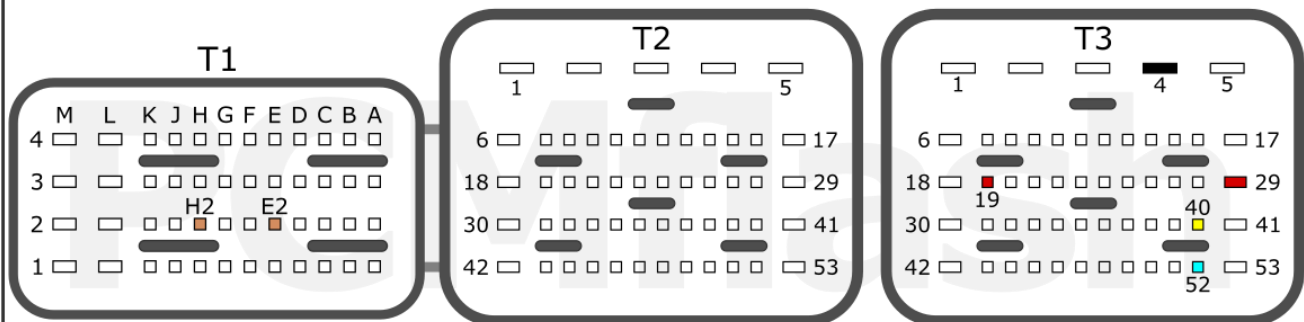

<b>+12V</b>	T3: 19, 29	<b>CAN-L</b>	T3: 52
<b>GND</b>	T3: 4	<b>CAN-H</b>	T3: 40
<b>GPT</b>	T1: H2, E2		

PSA

pcmflash.ru

v.1

2021-10-12

# PCMflash

Engine Control Unit

## ME(V)17.4.5 TC1796

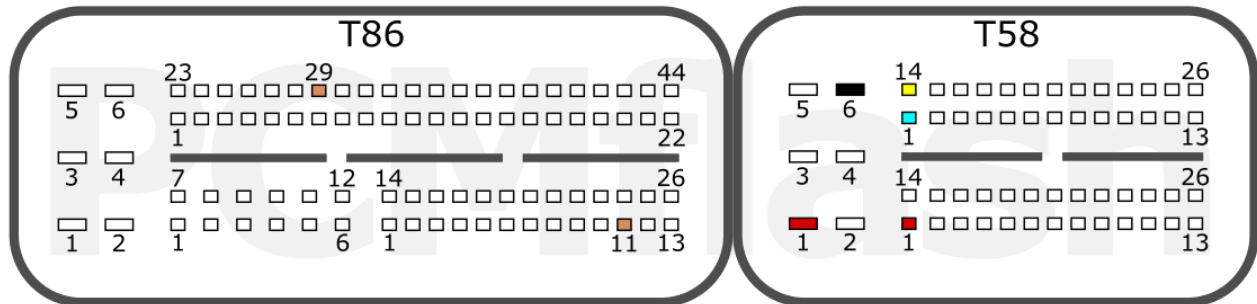

<b>+12V</b>	T58: 1, 1	<b>CAN-L</b>	T58: 1
<b>GND</b>	T58: 6	<b>CAN-H</b>	T58: 14
<b>GPT</b>	T86: 11, 29		

BMW

pcmflash.ru

v.2

2021-12-14

# PCMflash

Engine Control Unit

## MEV17.4.6 TC1796

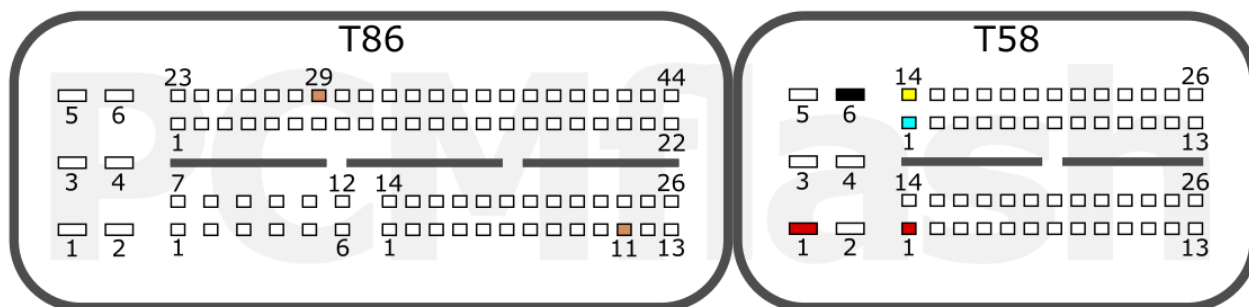

<b>+12V</b>	T58: 1, 1	<b>CAN-L</b>	T58: 1
<b>GND</b>	T58: 6	<b>CAN-H</b>	T58: 14
<b>GPT</b>	T86: 11, 29		

BMW

pcmflash.ru

v.2

2021-12-14

# PCMflash

Engine Control Unit

## ME17.5 TC1766

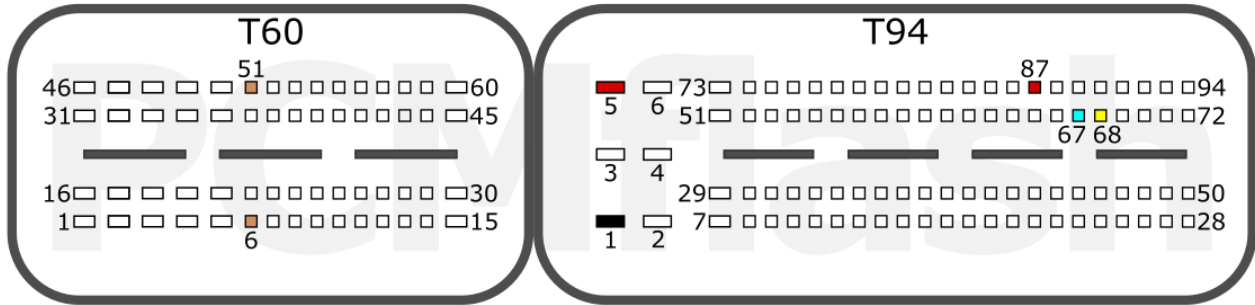

<b>+12V</b>	T94: 5, 87	<b>CAN-L</b>	T94: 67
<b>GND</b>	T94: 1	<b>CAN-H</b>	T94: 68
<b>GPT</b>	T60: 6, 51		

VAG

pcmflash.ru

v.1

2021-12-06



# PCMflash

Engine Control Unit

## MED17.5 TC1766

### SKODA

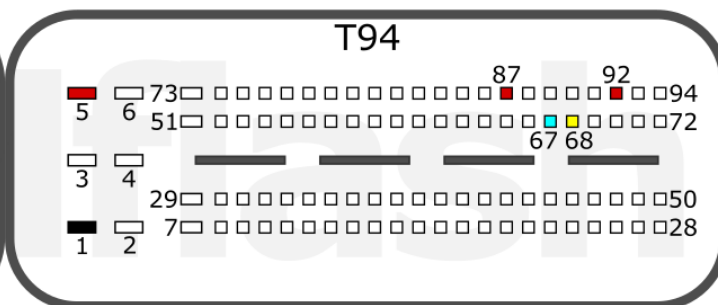
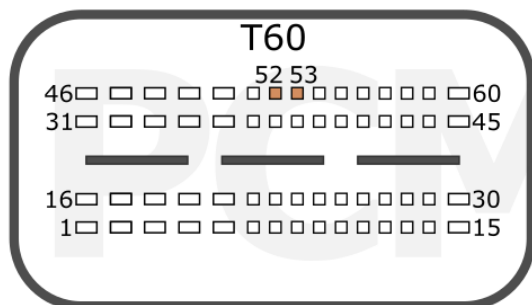

<b>+12V</b>	T94: 5, 87, 92	<b>CAN-L</b>	T94: 67
<b>GND</b>	T94: 1	<b>CAN-H</b>	T94: 68
<b>GPT</b>	T60: 52, 53		

### VAG

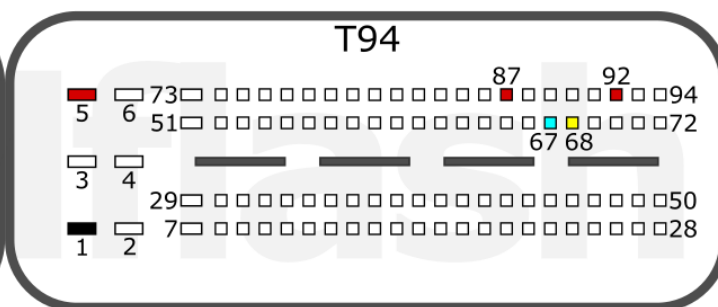
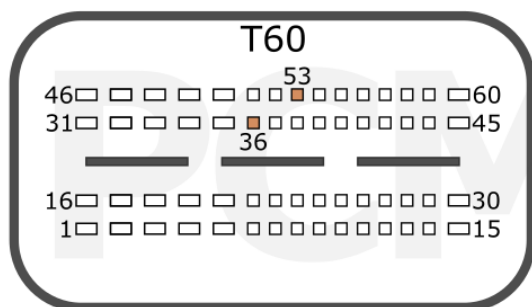

<b>+12V</b>	T94: 5, 87, 92	<b>CAN-L</b>	T94: 67
<b>GND</b>	T94: 1	<b>CAN-H</b>	T94: 68
<b>GPT</b>	T60: 53, 36		

SKODA

VAG

pcmflash.ru

v.2

2022-03-31

# PCMflash

Engine Control Unit

## MED17.5.1 TC1796

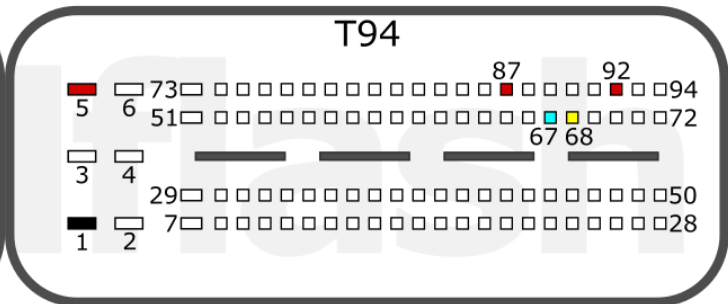
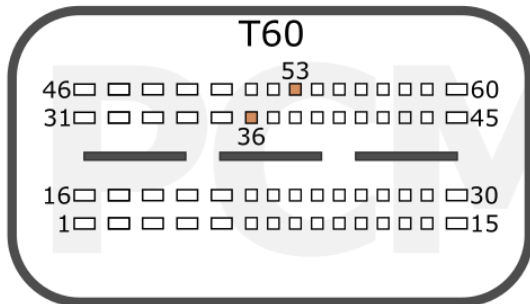

<b>+12V</b>	T94: 5, 87, 92	<b>CAN-L</b>	T94: 67
<b>GND</b>	T94: 1	<b>CAN-H</b>	T94: 68
<b>GPT</b>	T60: 36, 53		

VAG

pcmflash.ru

v.1

2021-10-11

# PCMflash

Engine Control Unit

## MED17.5.2 TC1767

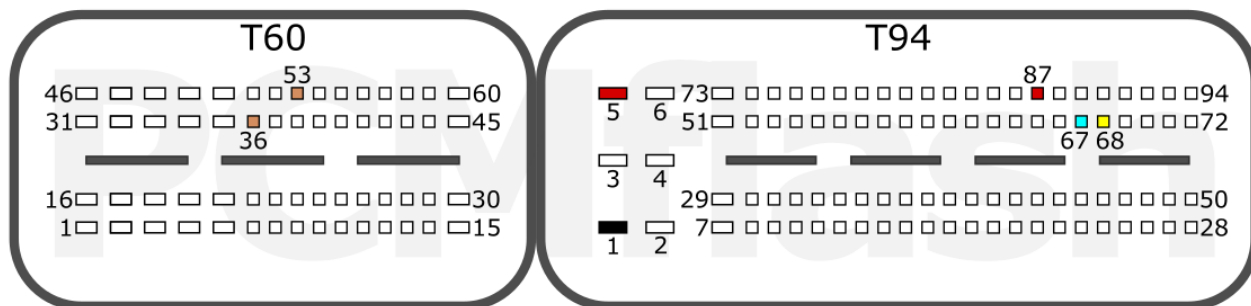

<b>+12V</b>	T94: 5, 87	<b>CAN-L</b>	T94: 67
<b>GND</b>	T94: 1	<b>CAN-H</b>	T94: 68
<b>GPT</b>	T60: 53, 36		

VAG

pcmflash.ru

v.1

2021-09-02

# PCMflash

Engine Control Unit

## MED17.5.5 TC1766

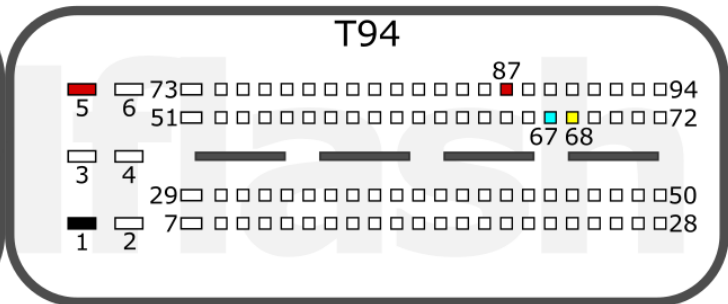
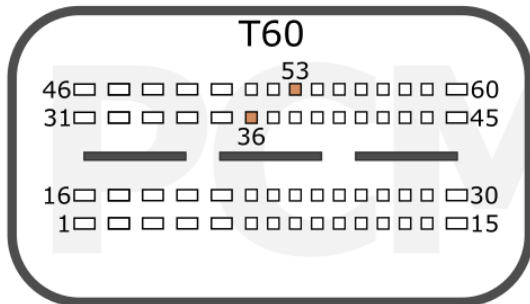

<b>+12V</b>	T94: 5, 87	<b>CAN-L</b>	T94: 67
<b>GND</b>	T94: 1	<b>CAN-H</b>	T94: 68
<b>GPT</b>	T60: 53, 36		

VAG

pcmflash.ru

v.1

2021-10-07

# PCMflash

Engine Control Unit

## ME17.5.6 TC1767

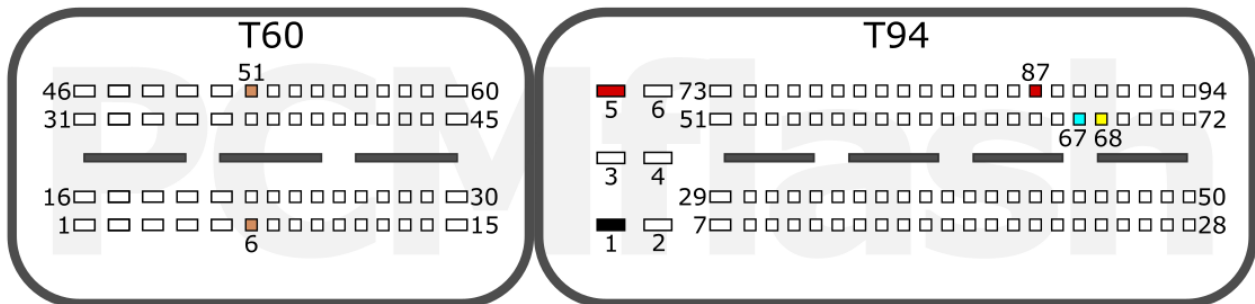

<b>+12V</b>	T94: 5, 87	<b>CAN-L</b>	T94: 67
<b>GND</b>	T94: 1	<b>CAN-H</b>	T94: 68
<b>GPT</b>	T60: 6, 51		

VAG

# PCMflash

Engine Control Unit

## MED17.5.20 TC1766

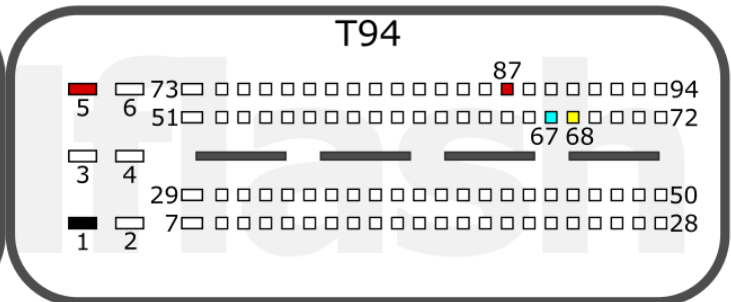
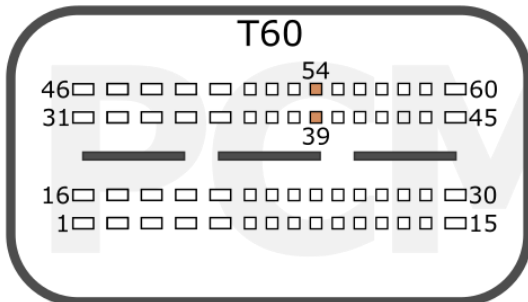

<b>+12V</b>	T94: 5, 87	<b>CAN-L</b>	T94: 67
<b>GND</b>	T94: 1	<b>CAN-H</b>	T94: 68
<b>GPT</b>	T60: 39, 54		

VAG

pcmflash.ru

v.1

2022-02-28

# PCMflash

Engine Control Unit

## MED17.5.21 TC1782

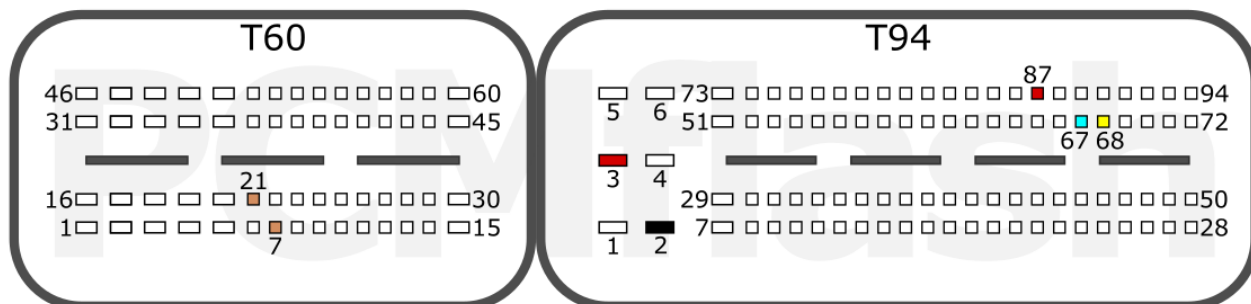

<b>+12V</b>	T94: 3, 87	<b>CAN-L</b>	T94: 67
<b>GND</b>	T94: 2	<b>CAN-H</b>	T94: 68
<b>GPT</b>	T60: 21, 7		

VAG

pcmflash.ru

v.1

2021-09-30

# PCMflash

Engine Control Unit

## MED17.5.25 TC1782

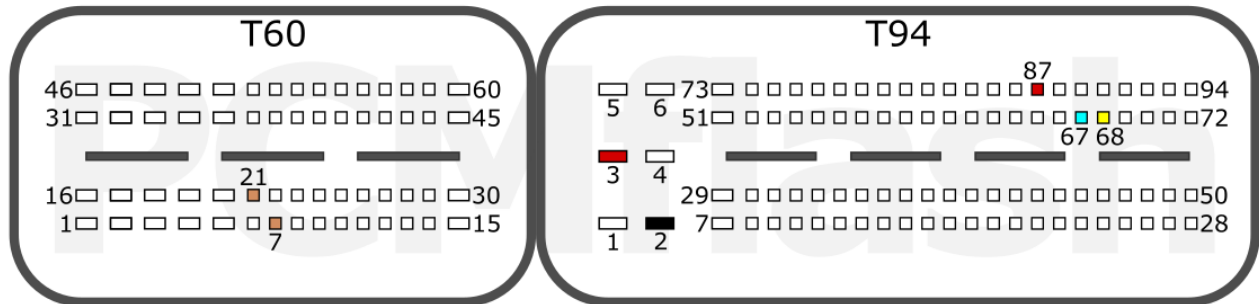

<b>+12V</b>	T94: 3, 87	<b>CAN-L</b>	T94: 67
<b>GND</b>	T94: 2	<b>CAN-H</b>	T94: 68
<b>GPT</b>	T60: 21, 7		

SKODA

pcmflash.ru

v.1

2021-09-26



# PCMflash

Engine Control Unit

## ME17.5.26 TC1724

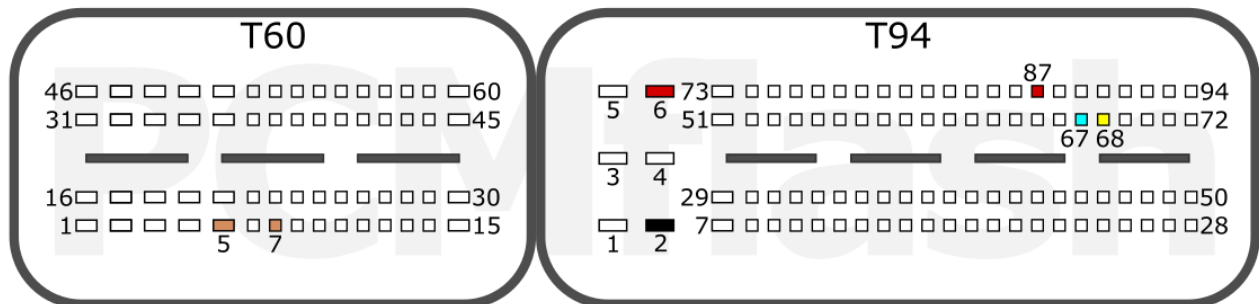

<b>+12V</b>	T94: 6, 87	<b>CAN-L</b>	T94: 67
<b>GND</b>	T94: 2	<b>CAN-H</b>	T94: 68
<b>GPT</b>	T60: 7, 5		

VAG

pcmflash.ru

v.1

2021-08-27

# PCMflash

Engine Control Unit

## ME17.7 TC1796

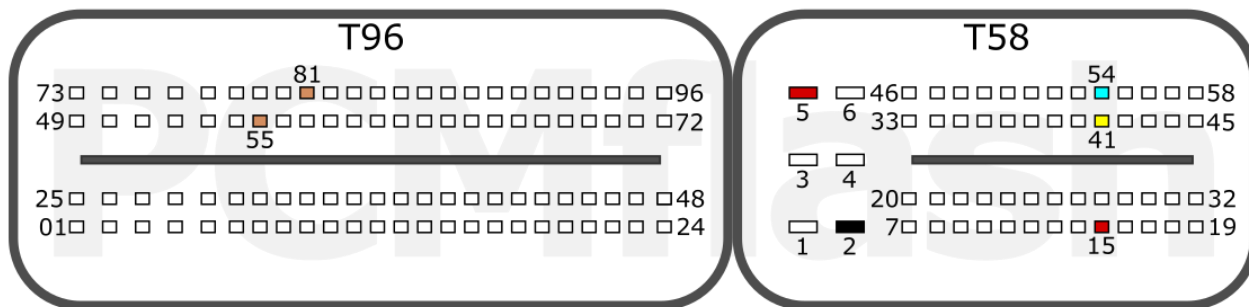

<b>+12V</b>	T58: 5, 15	<b>CAN-L</b>	T58: 54
<b>GND</b>	T58: 2	<b>CAN-H</b>	T58: 41
<b>GPT</b>	T96: 81, 55		

MB

pcmflash.ru

v.1

2021-10-13

# PCMflash

Engine Control Unit

## MED17.7.1 TC1797

### Connection version 1



<b>+12V</b>	T58: 5, 15	<b>CAN-L</b>	T58: 54
<b>GND</b>	T58: 2	<b>CAN-H</b>	T58: 41
<b>GPT</b>	T96: 83, 58		

### Connection version 2

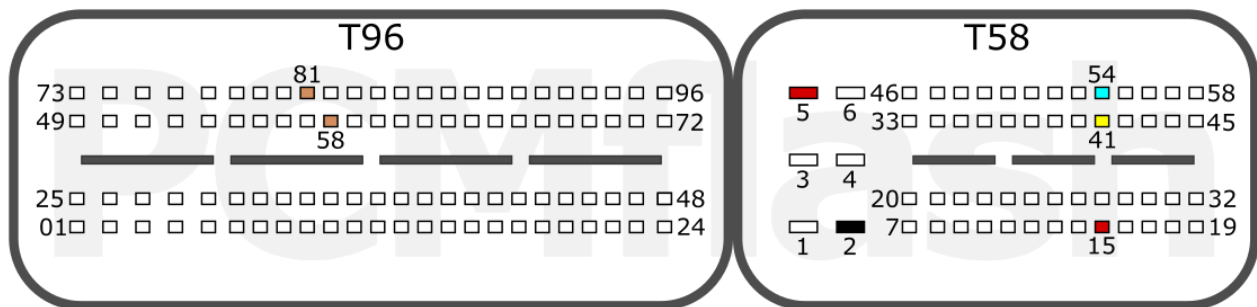

<b>+12V</b>	T58: 5, 15	<b>CAN-L</b>	T58: 54
<b>GND</b>	T58: 2	<b>CAN-H</b>	T58: 41
<b>GPT</b>	T96: 81, 58		

MB

pcmflash.ru

v.1

2021-11-01

# PCMflash

Engine Control Unit

## MED17.7.2 TC1797

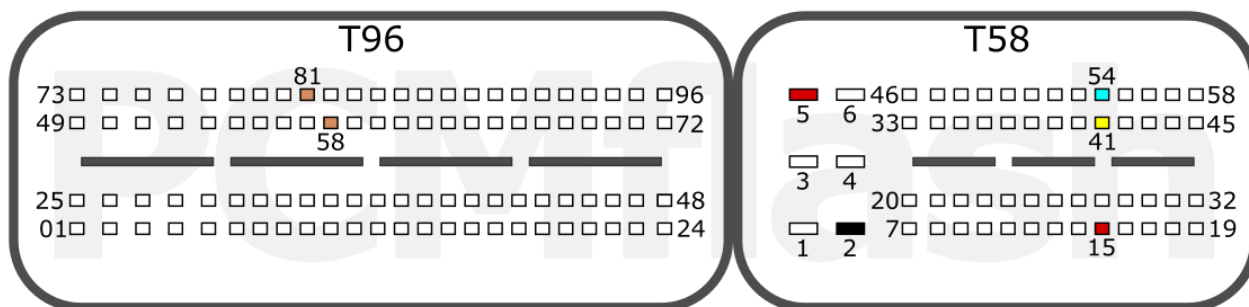

<b>+12V</b>	T58: 5, 15	<b>CAN-L</b>	T58: 54
<b>GND</b>	T58: 2	<b>CAN-H</b>	T58: 41
<b>GPT</b>	T96: 81, 58		

INFINITI

MB

pcmflash.ru

v.1

2021-09-08

# PCMflash

Engine Control Unit

## MED17.7.3 TC1797

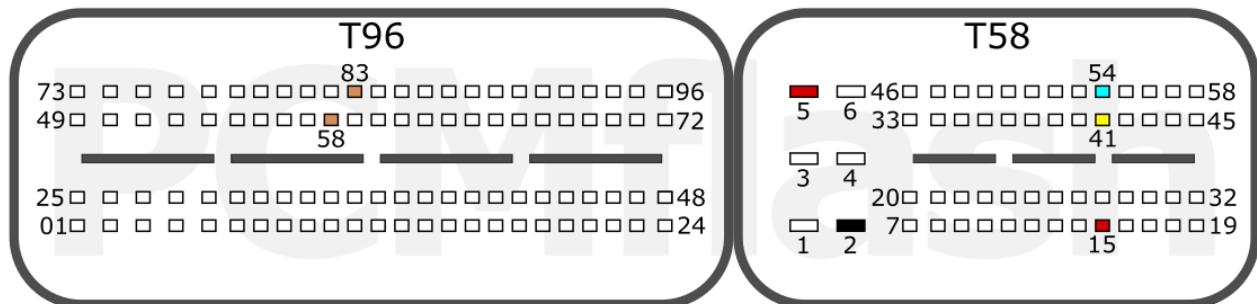

<b>+12V</b>	T58: 5, 15	<b>CAN-L</b>	T58: 54
<b>GND</b>	T58: 2	<b>CAN-H</b>	T58: 41
<b>GPT</b>	T96: 83, 58		

MB

pcmflash.ru

v.1

2021-09-08

# PCMflash

Engine Control Unit

## MED17.7.3.1 TC1797



<b>+12V</b>	T58: 5, 15	<b>CAN-L</b>	T58: 54
<b>GND</b>	T58: 2	<b>CAN-H</b>	T58: 41
<b>GPT</b>	T96: 83, 58		

MB

pcmflash.ru

v.1

2021-11-01

# PCMflash

Engine Control Unit

## MED17.7.5 TC1793

T105

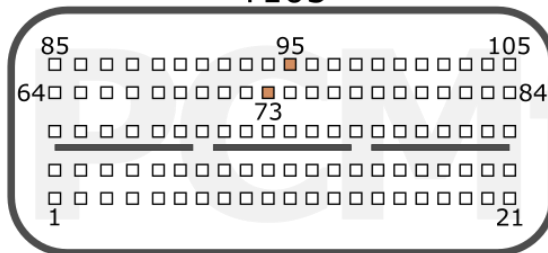

T91

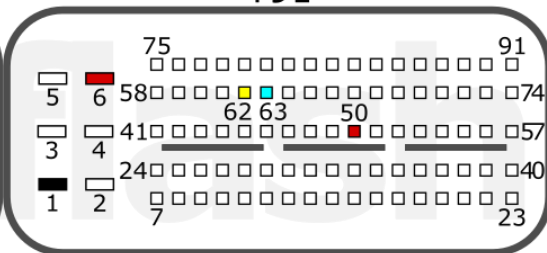

<b>+12V</b>	T91: 6, 50	<b>CAN-L</b>	T91: 63
<b>GND</b>	T91: 1	<b>CAN-H</b>	T91: 62
<b>GPT</b>	T105: 73, 95		

MB

pcmflash.ru

v.1

2021-10-06

# PCMflash

Engine Control Unit

## MED17.7.7 TC1793

### Connection version 1



<b>+12V</b>	T58: 3, 15, 16	<b>CAN-L</b>	T58: 54
<b>GND</b>	T58: 4	<b>CAN-H</b>	T58: 41
<b>GPT</b>	T96: 58, 82		

### Connection version 2

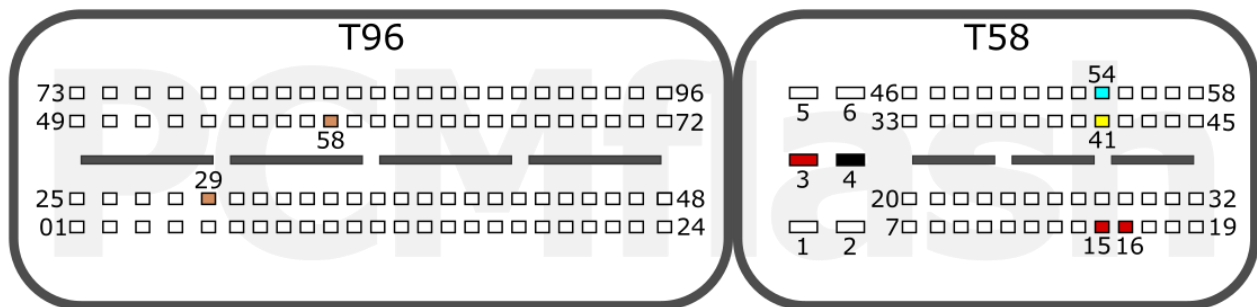

<b>+12V</b>	T58: 3, 15, 16	<b>CAN-L</b>	T58: 54
<b>GND</b>	T58: 4	<b>CAN-H</b>	T58: 41
<b>GPT</b>	T96: 29, 58		

MB

pcmflash.ru

v.1

2021-09-10



# PCMflash

Engine Control Unit

## MED17.8.2 TC1767

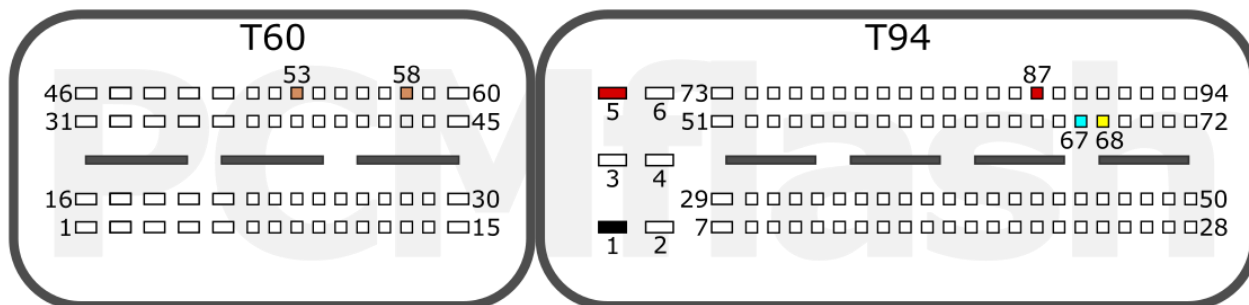

<b>+12V</b>	T94: 5, 87	<b>CAN-L</b>	T94: 67
<b>GND</b>	T94: 1	<b>CAN-H</b>	T94: 68
<b>GPT</b>	T60: 53, 58		

GEELY

# PCMflash

Engine Control Unit

MEVD17.8.4 TC1797

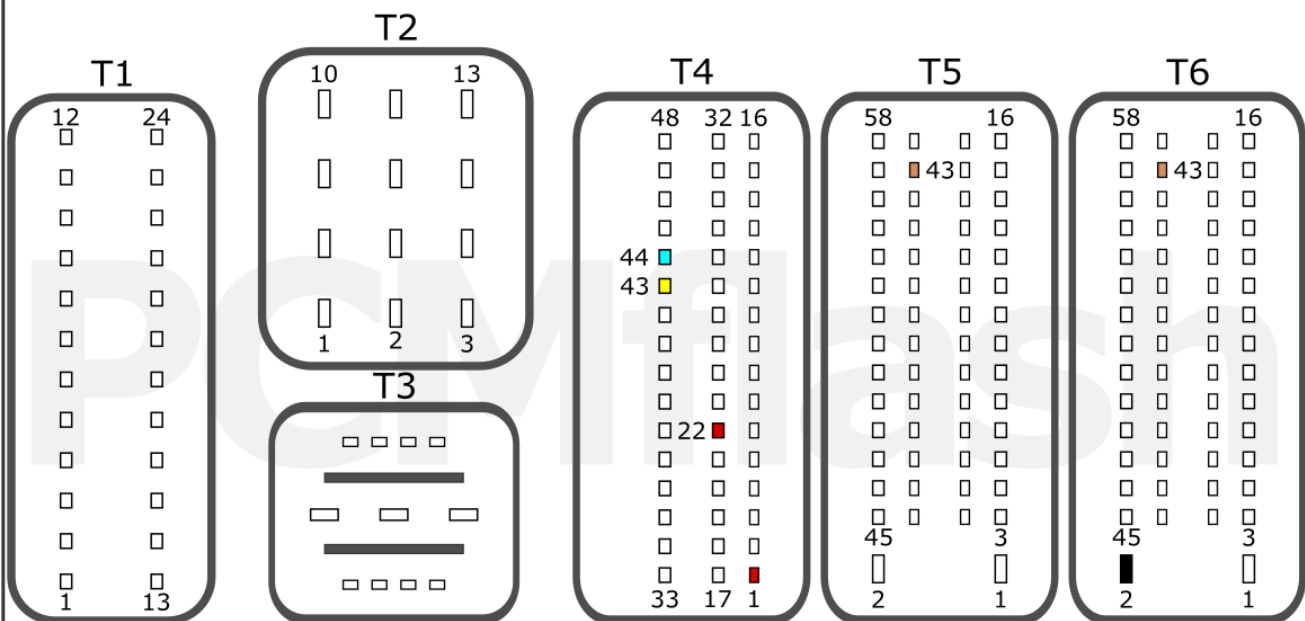

<b>+12V</b>	T4: 1, 22	<b>CAN-L</b>	T4: 44
<b>GND</b>	T6: 2	<b>CAN-H</b>	T4: 43
<b>GPT</b>	T5: 43, T6: 43		

BMW

pcmflash.ru

v.1

2021-11-01

# PCMflash

Engine Control Unit

## ME17.8.5 TC1762

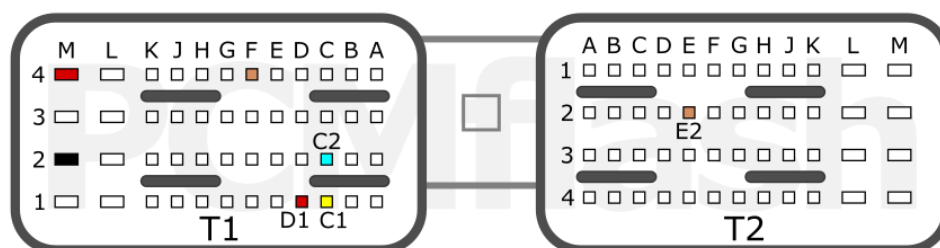

<b>+12V</b>	T1: M4, D1	<b>CAN-L</b>	T1: C2
<b>GND</b>	T1: M2	<b>CAN-H</b>	T1: C1
<b>GPT</b>	T1: F4, T2:E2		

ROTAX

pcmflash.ru

v.1

2021-09-28

## PCMflash

Engine Control Unit

## M17.8.7 TC1762

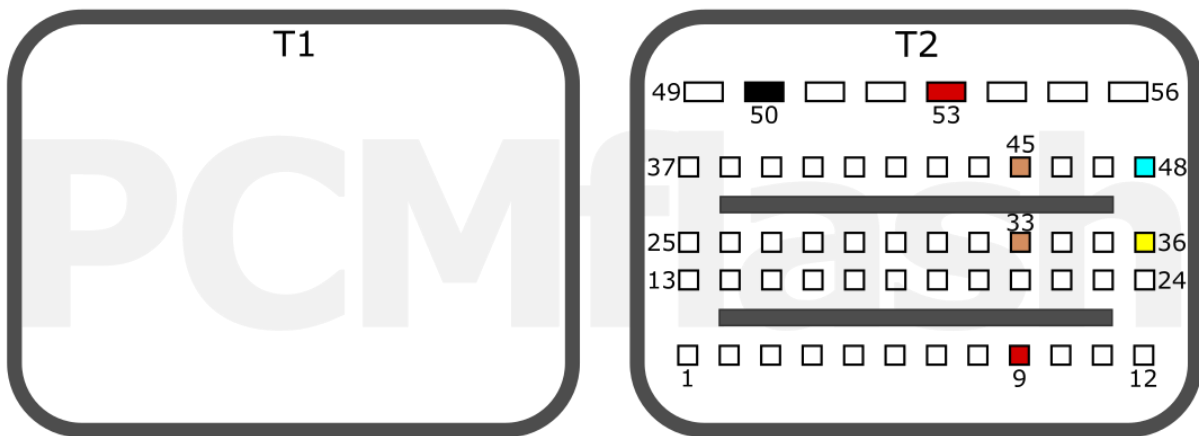

<b>+12V</b>	T2: 53, 9	<b>CAN-L</b>	T2: 48
<b>GND</b>	T2: 50	<b>CAN-H</b>	T2: 36
<b>GPT</b>	T2: 45, 33		

POLARIS ATV

pcmflash.ru

v.1

2021-12-09

# PCMflash

Engine Control Unit

ME17.8.8/ME17.8.8.1/ME17U6 TC1728/TC1782

## Connection version 1



<b>+12V</b>	T1: 20, 35	<b>CAN-L</b>	T1: 17
<b>GND</b>	T1: 64	<b>CAN-H</b>	T1: 1
<b>GPT*</b>	T2: 93, 96		

\*Select "Use other GPT output pins" in the pcmflash settings or set GPT to EXT in case powerbox for PCMflash is used /  
 При использовании powerbox for PCMflash выбрать режим GPT EXT или использовать альтернативные пины

## Connection version 2



<b>+12V</b>	T1: 20, 35	<b>CAN-L</b>	T1: 3
<b>GND</b>	T1: 64	<b>CAN-H</b>	T1: 4
<b>GPT*</b>	T2: 93, 96		

\*Select "Use other GPT output pins" in the pcmflash settings or set GPT to EXT in case powerbox for PCMflash is used /  
 При использовании powerbox for PCMflash выбрать режим GPT EXT или использовать альтернативные пины

CHINA

pcmflash.ru

v.1

2023-07-01



# PCMflash

Engine Control Unit

## MED17.8.21 TC1767

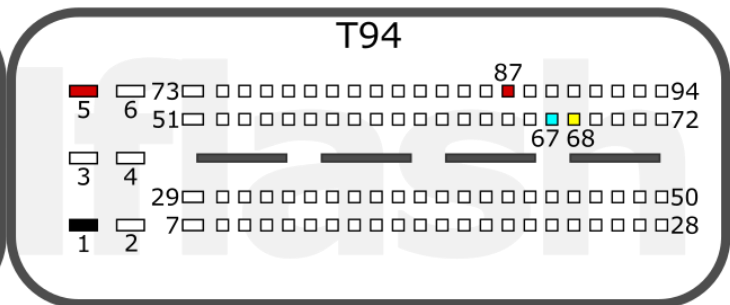
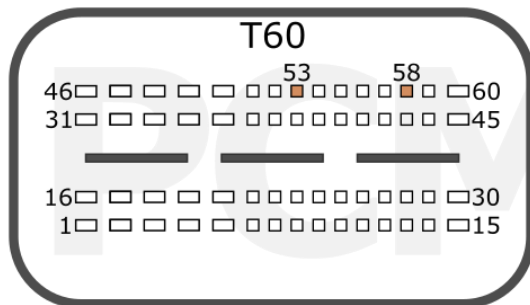

<b>+12V</b>	T94: 5, 87	<b>CAN-L</b>	T94: 67
<b>GND</b>	T94: 1	<b>CAN-H</b>	T94: 68
<b>GPT</b>	T60: 53, 58		

FOTON

pcmflash.ru

v.1

2021-10-31

# PCMflash

Engine Control Unit

## MED17.8.31 TC1797

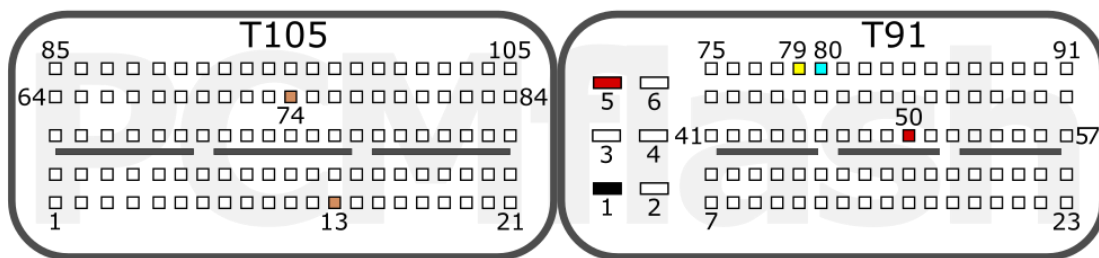

<b>+12V</b>	T91: 5, 50	<b>CAN-L</b>	T91: 80
<b>GND</b>	T91: 1	<b>CAN-H</b>	T91: 79
<b>GPT</b>	T105: 13, 74		

JLR

pcmflash.ru

v.1

2021-09-11



# PCMflash

Engine Control Unit

ME17.8.32 TC1797

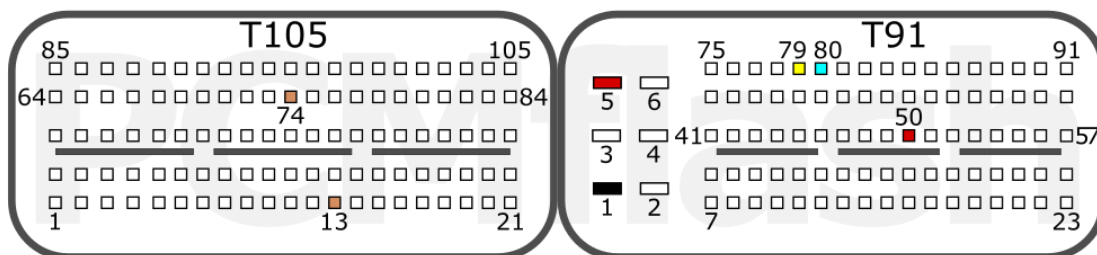

<b>+12V</b>	T91: 5, 50	<b>CAN-L</b>	T91: 80
<b>GND</b>	T91: 1	<b>CAN-H</b>	T91: 79
<b>GPT</b>	T105: 74, 13		

MCLAREN

pcmflash.ru

v.1

2021-10-14

# PCMflash

Engine Control Unit

## MED17.8.32 TC1793

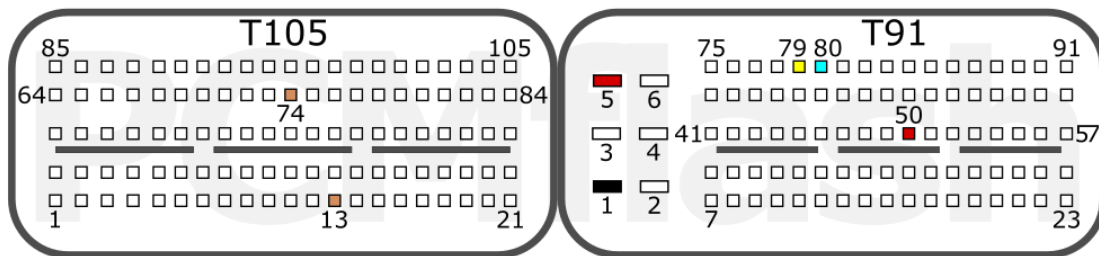

<b>+12V</b>	T91: 5, 50	<b>CAN-L</b>	T91: 80
<b>GND</b>	T91: 1	<b>CAN-H</b>	T91: 79
<b>GPT</b>	T105: 13, 74		

JLR

pcmflash.ru

v.1

2021-10-12

# PCMflash

Engine Control Unit

## MED17.8.34 TC1793

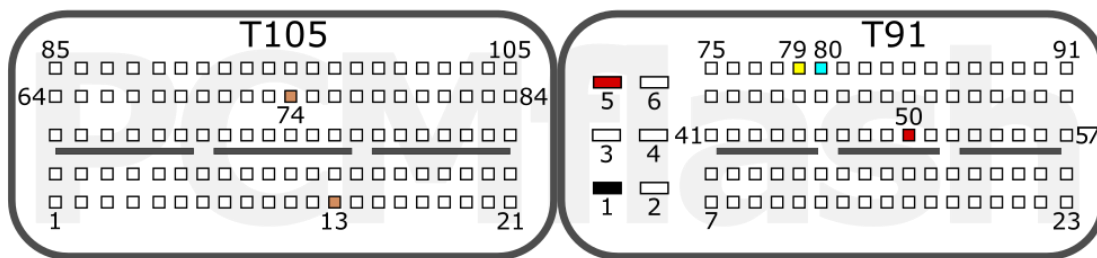

<b>+12V</b>	T91: 5, 50	<b>CAN-L</b>	T91: 80
<b>GND</b>	T91: 1	<b>CAN-H</b>	T91: 79
<b>GPT</b>	T105: 13, 74		

AURUS

pcmflash.ru

v.1

2023-08-03

# PCMflash

Engine Control Unit

## MEDC17.9 TC1793

T105

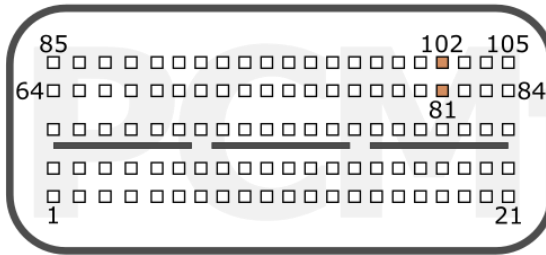

T91

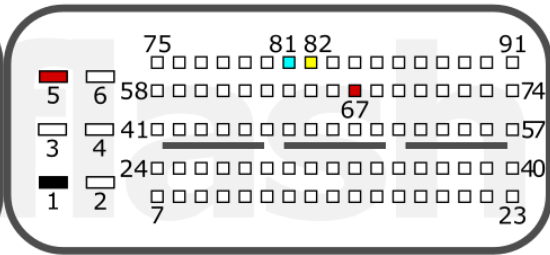

<b>+12V</b>	T91: 5, 67	<b>CAN-L</b>	T91: 81
<b>GND</b>	T91: 1	<b>CAN-H</b>	T91: 82
<b>GPT</b>	T105: 81, 102		

JLR

pcmflash.ru

v.1

2021-10-09

# PCMflash

Engine Control Unit

## MEG17.9.2 TC1767

T105



T91

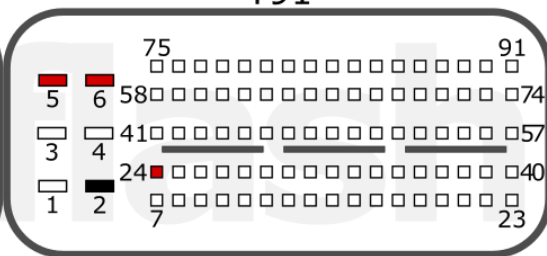

<b>+12V</b>	T91: 5, 6, 24	<b>CAN-L</b>	T105: 81
<b>GND</b>	T91: 2	<b>CAN-H</b>	T105: 102
<b>GPT</b>	T105: 54, 73		

K/H

pcmflash.ru

v.1

2022-03-04

# PCMflash

Engine Control Unit

## MED17.9.3 TC1793

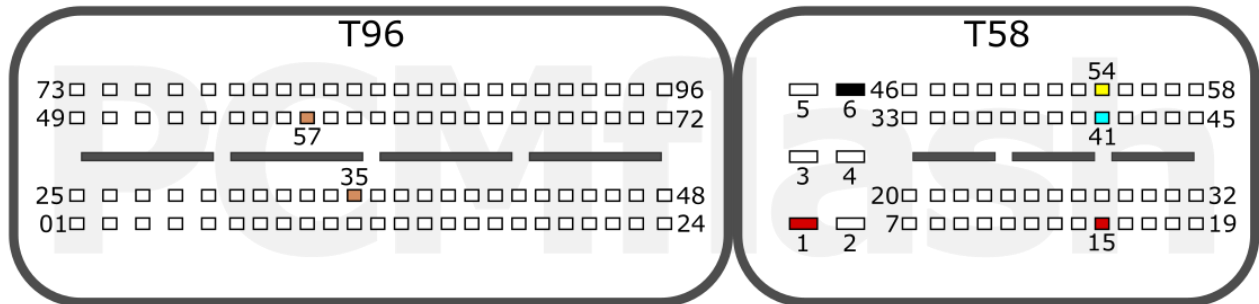

<b>+12V</b>	T58: 1, 15	<b>CAN-L</b>	T58: 41
<b>GND</b>	T58: 6	<b>CAN-H</b>	T58: 54
<b>GPT</b>	T96: 35, 57		

HONDA

pcmflash.ru

v.1

2021-10-31

# PCMflash

Engine Control Unit

## ME17.9.6 TC1767

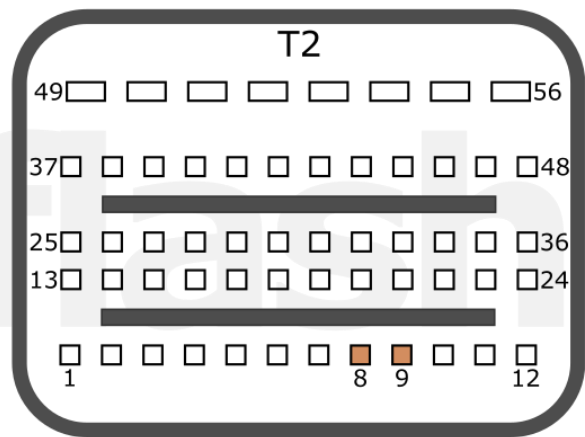
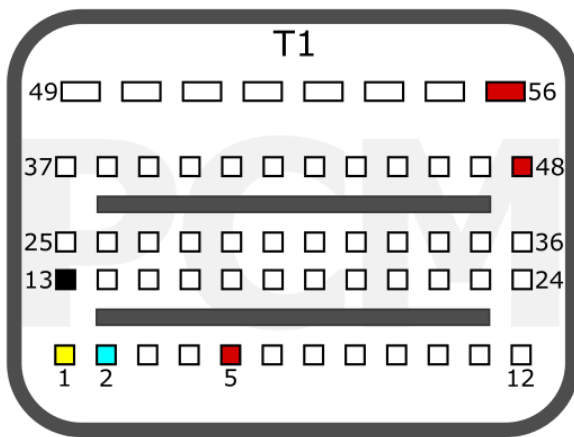

<b>+12V</b>	T1: 56, 48, 5	<b>CAN-L</b>	T1: 2
<b>GND</b>	T1: 13	<b>CAN-H</b>	T1: 1
<b>GPT</b>	T2: 8, 9		

SUZUKI

pcmflash.ru

v.1

2021-10-10

# PCMflash

Engine Control Unit

## ME17.9.7 TC1762

### UAZ

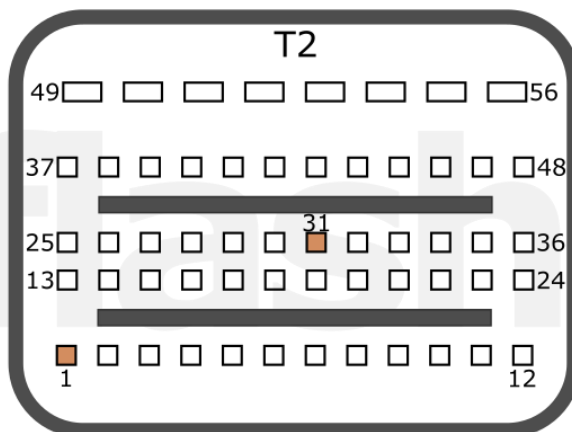
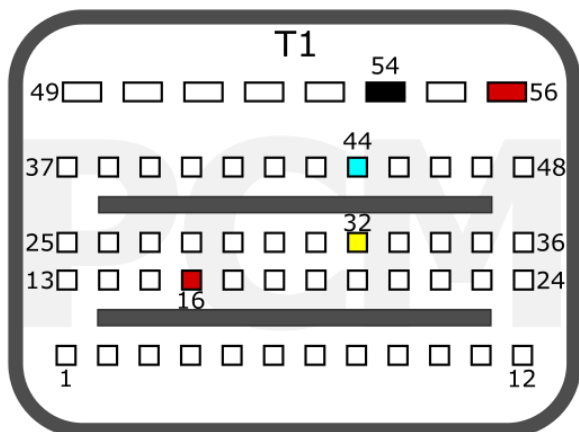

<b>+12V</b>	T1: 56, 16	<b>CAN-L</b>	T1: 44
<b>GND</b>	T1: 54	<b>CAN-H</b>	T1: 32
<b>GPT</b>	T2: 1, 31		

### VAZ

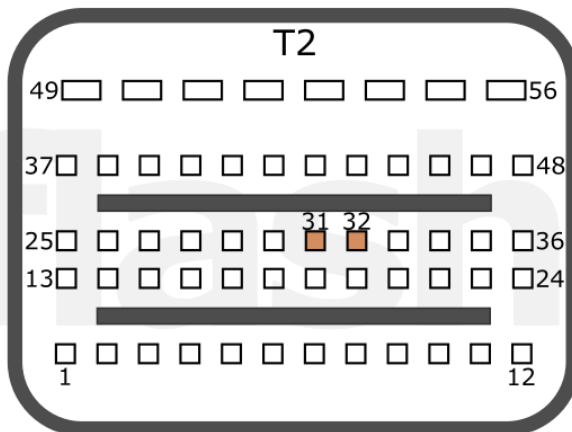
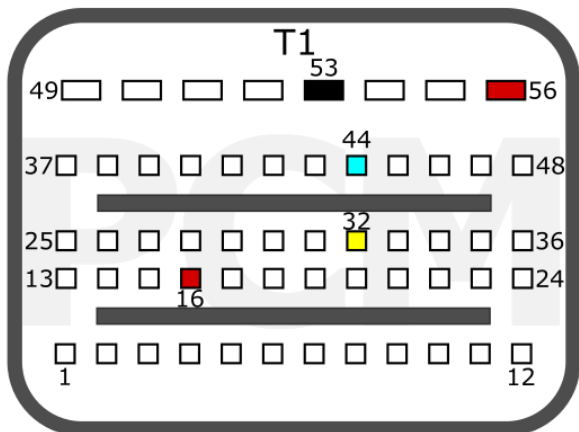

<b>+12V</b>	T1: 56, 16	<b>CAN-L</b>	T1: 44
<b>GND</b>	T1: 53	<b>CAN-H</b>	T1: 32
<b>GPT</b>	T2: 32, 31		

VAZ

UAZ

pcmflash.ru

v.1

2021-09-03





# PCMflash

Engine Control Unit

## ME(D)17.9.8 TC1767

### Connection version 1

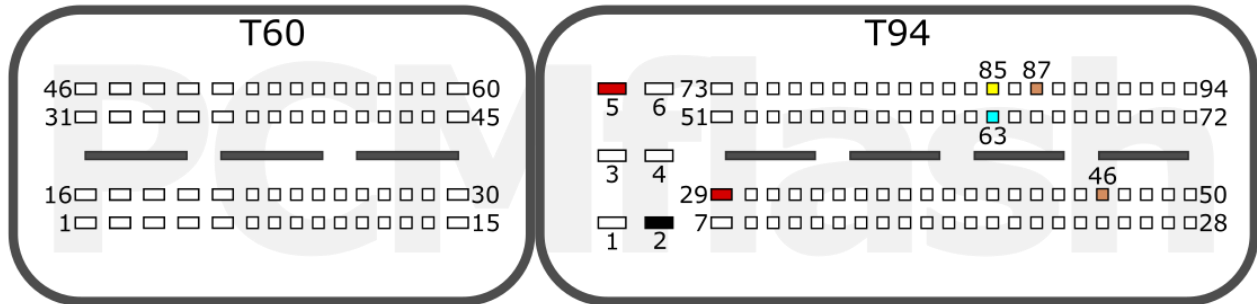

<b>+12V</b>	T94: 5, 29	<b>CAN-L</b>	T94: 63
<b>GND</b>	T94: 2	<b>CAN-H</b>	T94: 85
<b>GPT</b>	T94: 46, 87		

### Connection version 2

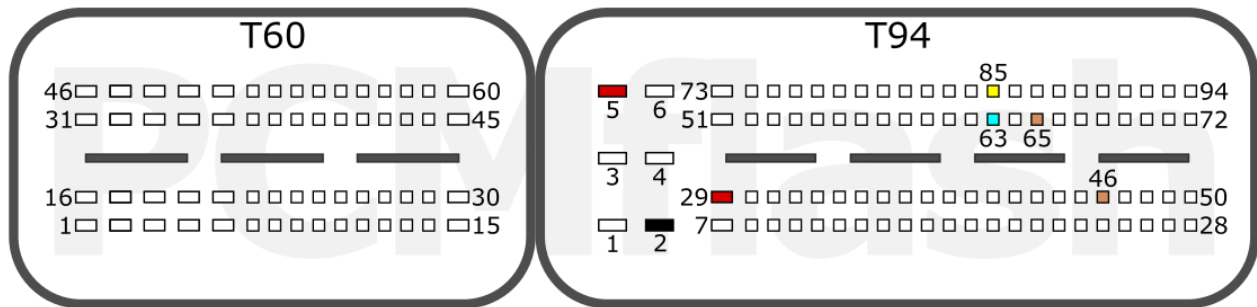

<b>+12V</b>	T94: 5, 29	<b>CAN-L</b>	T94: 63
<b>GND</b>	T94: 2	<b>CAN-H</b>	T94: 85
<b>GPT</b>	T94: 46, 65		

### Connection version 3

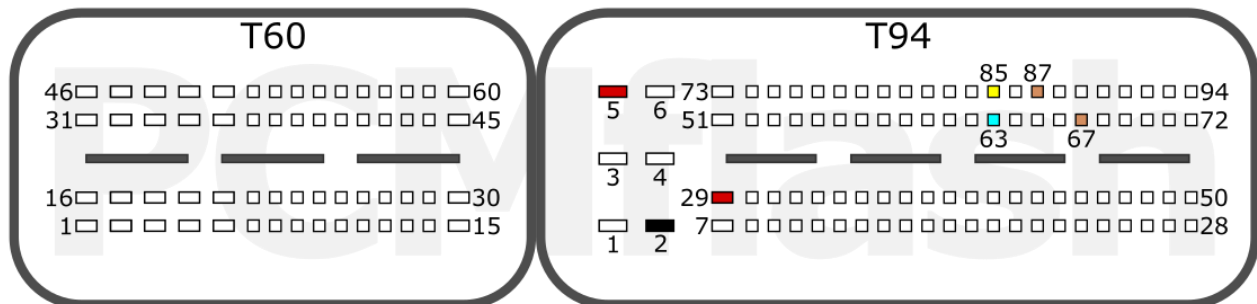

<b>+12V</b>	T94: 5, 29	<b>CAN-L</b>	T94: 63
<b>GND</b>	T94: 2	<b>CAN-H</b>	T94: 85
<b>GPT</b>	T94: 67, 87		

K/H

# PCMflash

Engine Control Unit

## MEG17.9.8 TC1767

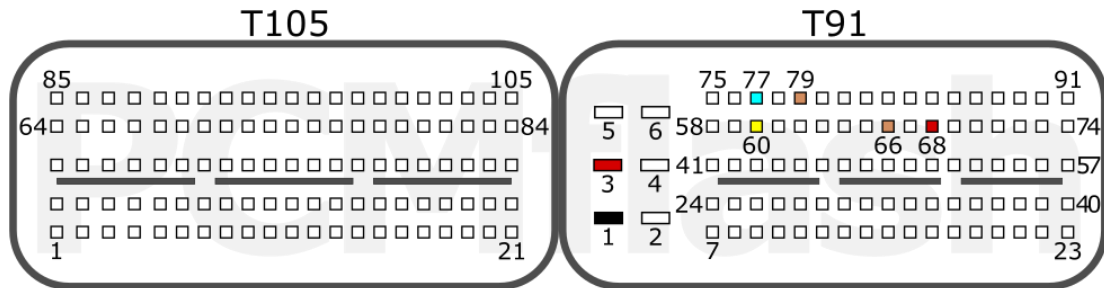

<b>+12V</b>	T91: 3, 68	<b>CAN-L</b>	T91: 77
<b>GND</b>	T91: 1	<b>CAN-H</b>	T91: 60
<b>GPT</b>	T91: 66, 79		

K/H

pcmflash.ru

v.1

2021-10-15

# PCMflash

Engine Control Unit

## MEDG17.9.8 TC1767

### Connection version 1

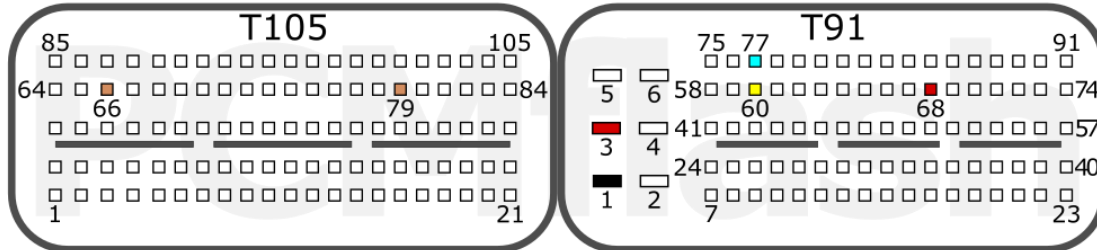

<b>+12V</b>	T91: 3, 68	<b>CAN-L</b>	T91: 77
<b>GND</b>	T91: 1	<b>CAN-H</b>	T91: 60
<b>GPT</b>	T105: 66, 79		

### Connection version 2

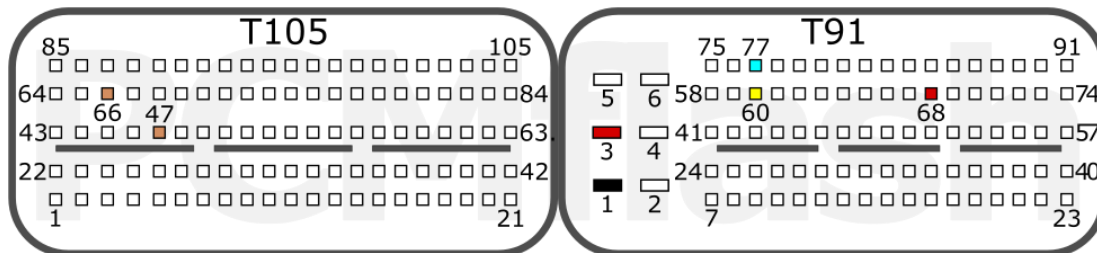

<b>+12V</b>	T91: 3, 68	<b>CAN-L</b>	T91: 77
<b>GND</b>	T91: 1	<b>CAN-H</b>	T91: 60
<b>GPT</b>	T105: 66, 47		

### Connection version 3

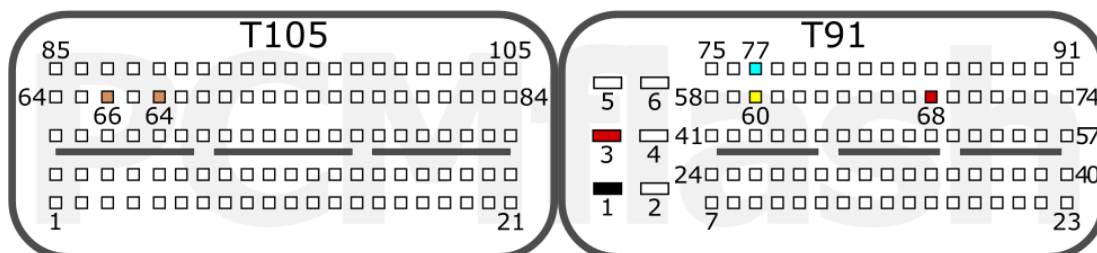

<b>+12V</b>	T91: 3, 68	<b>CAN-L</b>	T91: 77
<b>GND</b>	T91: 1	<b>CAN-H</b>	T91: 60
<b>GPT</b>	T105: 66, 64		

K/H

pcmflash.ru

v.2

2022-04-17

# PCMflash

Engine Control Unit

## MED17.9.9 TC1793

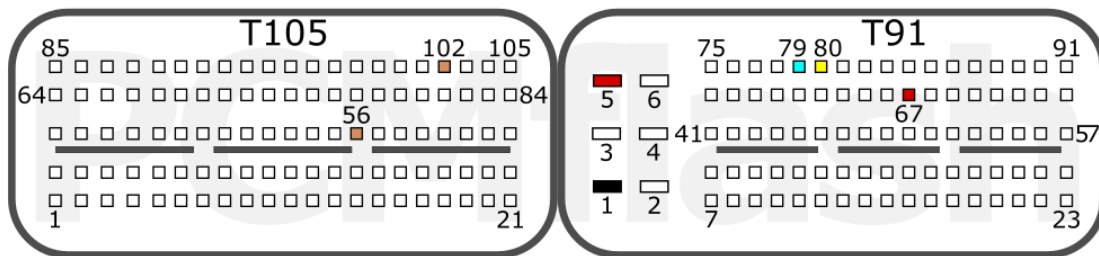

<b>+12V</b>	T91: 5, 67	<b>CAN-L</b>	T91: 79
<b>GND</b>	T91: 1	<b>CAN-H</b>	T91: 80
<b>GPT</b>	T105: 56, 102		

JLR

pcmflash.ru

v.1

2021-09-11

# PCMflash

Engine Control Unit

## ME17.9.11 TC1762

### Connection version 1

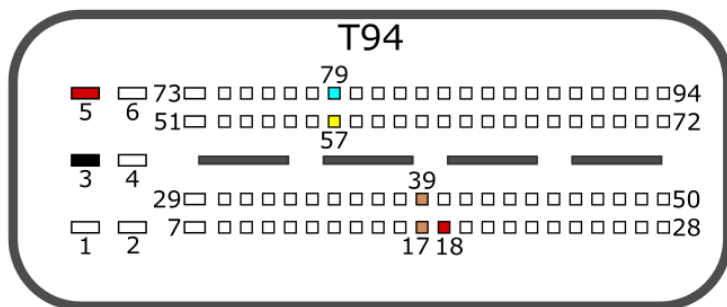

<b>+12V</b>	T94: 5, 18	<b>CAN-L</b>	T94: 79
<b>GND</b>	T94: 3	<b>CAN-H</b>	T94: 57
<b>GPT</b>	T94: 17, 39		

### Connection version 2

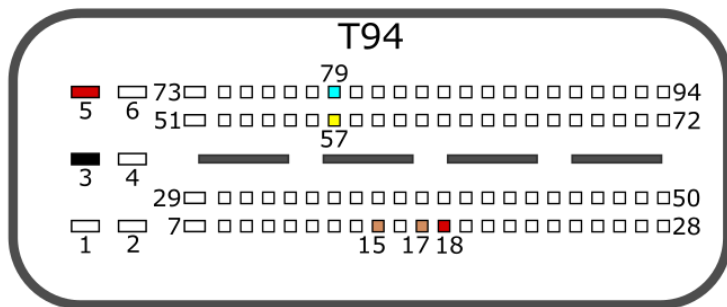

<b>+12V</b>	T94: 5, 18	<b>CAN-L</b>	T94: 79
<b>GND</b>	T94: 3	<b>CAN-H</b>	T94: 57
<b>GPT</b>	T94: 17, 15		

K/H

# PCMflash

Engine Control Unit

MEG17.9.12/17.9.13 TC1762

## Connection version 1

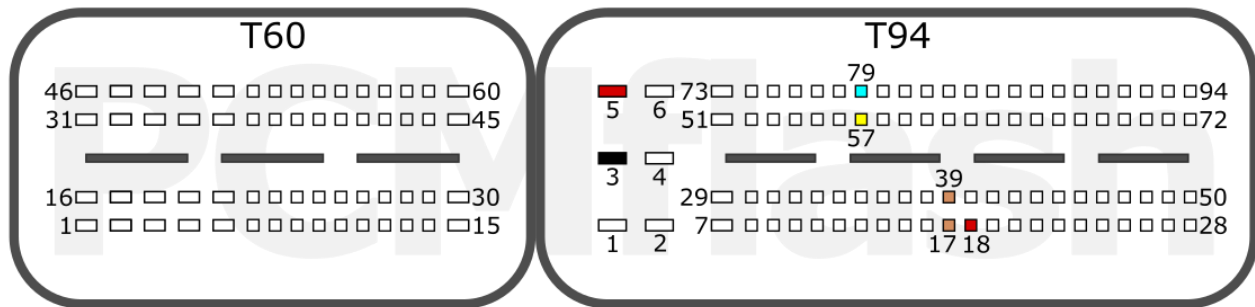

<b>+12V</b>	T94: 5, 18	<b>CAN-L</b>	T94: 79
<b>GND</b>	T94: 3	<b>CAN-H</b>	T94: 57
<b>GPT</b>	T94: 17, 39		

## Connection version 2

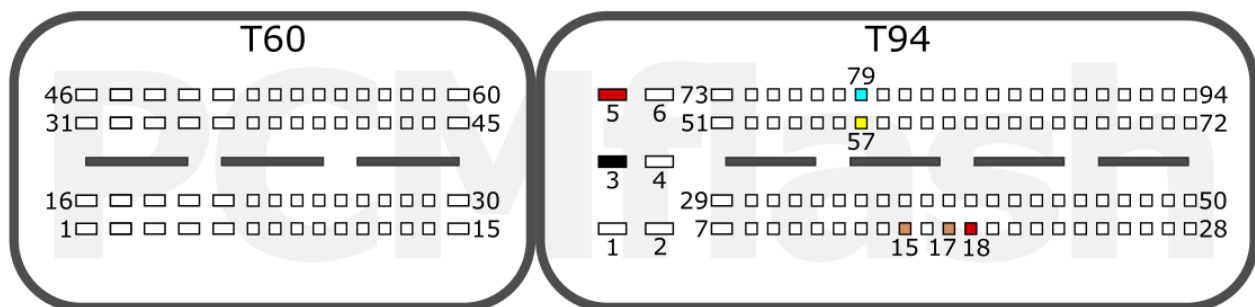

<b>+12V</b>	T94: 5, 18	<b>CAN-L</b>	T94: 79
<b>GND</b>	T94: 3	<b>CAN-H</b>	T94: 57
<b>GPT</b>	T94: 17, 15		

K/H

pcmflash.ru

v.2

2023-12-08

# PCMflash

Engine Control Unit

## ME17.9.20 TC1782

### BRABUS, SMART

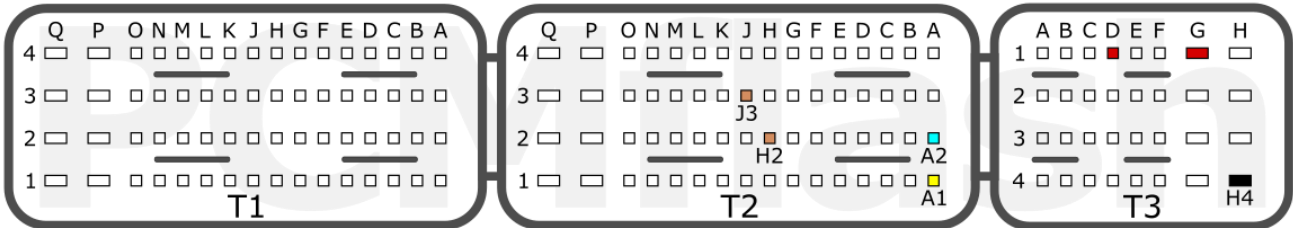

<b>+12V</b>	T3: D1, G1	<b>CAN-L</b>	T2: A2
<b>GND</b>	T3: H4	<b>CAN-H</b>	T2: A1
<b>GPT</b>	T2: H2, J3		

### RENAULT

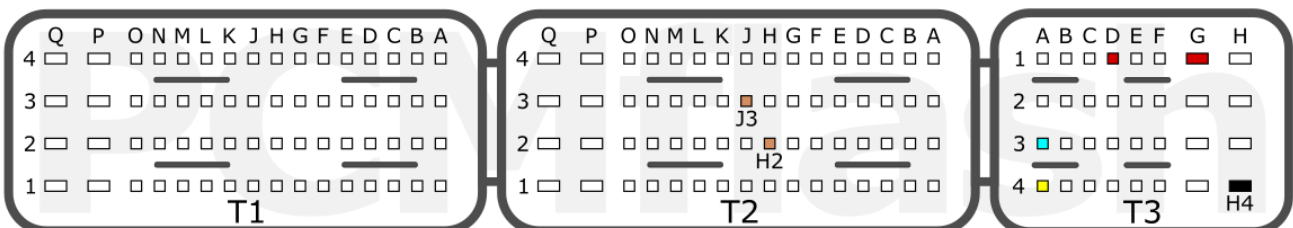

<b>+12V</b>	T3: D1, G1	<b>CAN-L</b>	T3: A3
<b>GND</b>	T3: H4	<b>CAN-H</b>	T3: A4
<b>GPT</b>	T2: H2, J3		

BRABUS

RENAULT

SMART

pcmflash.ru

v.1

2021-10-31



# PCMflash

Engine Control Unit

## MEG17.9.21 TC1724

### Connection version 1

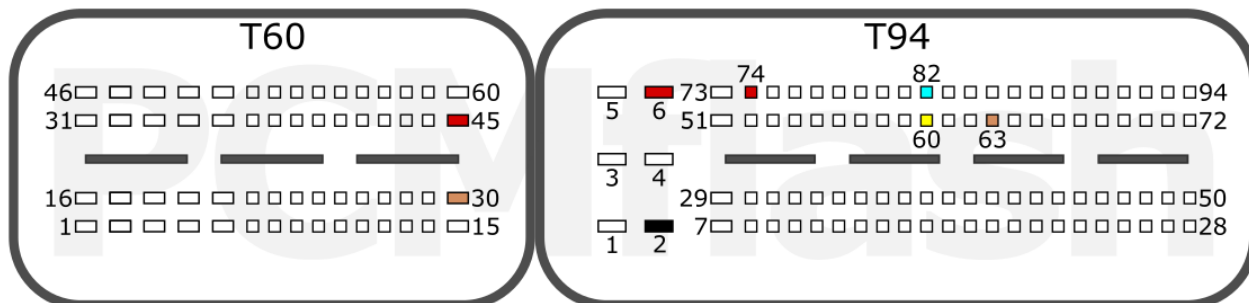

<b>+12V</b>	T60: 45, T94: 6, 74	<b>CAN-L</b>	T94: 82
<b>GND</b>	T94: 2	<b>CAN-H</b>	T94: 60
<b>GPT</b>	T60: 30, T94: 63		

### Connection version 2

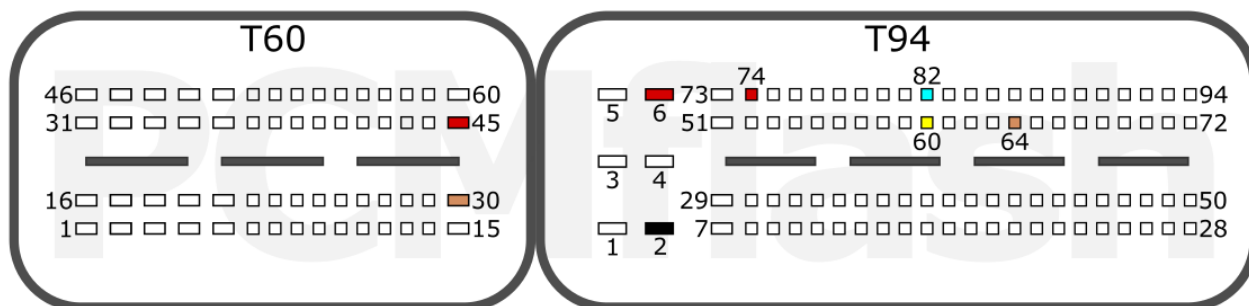

<b>+12V</b>	T60: 45, T94: 6, 74	<b>CAN-L</b>	T94: 82
<b>GND</b>	T94: 2	<b>CAN-H</b>	T94: 60
<b>GPT</b>	T60: 30, T94: 64		

### Connection version 3

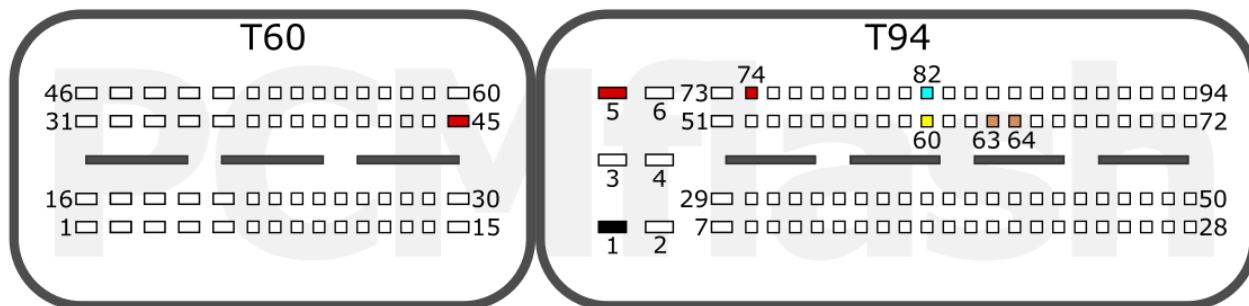

<b>+12V</b>	T60: 45, T94: 5, 74	<b>CAN-L</b>	T94: 82
<b>GND</b>	T94: 1	<b>CAN-H</b>	T94: 60
<b>GPT</b>	T94: 63, 64		

K/H

# PCMflash

Engine Control Unit

## ME17.9.21.1 TC1724

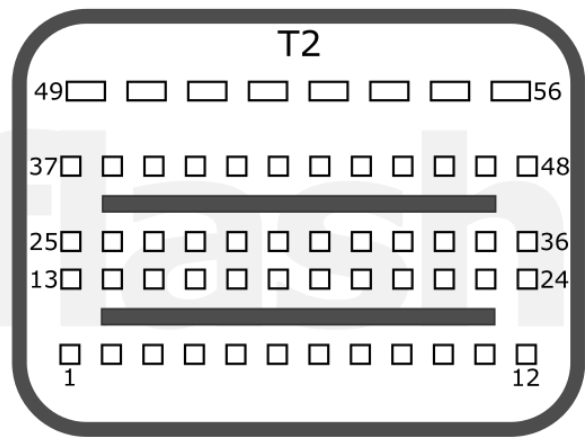
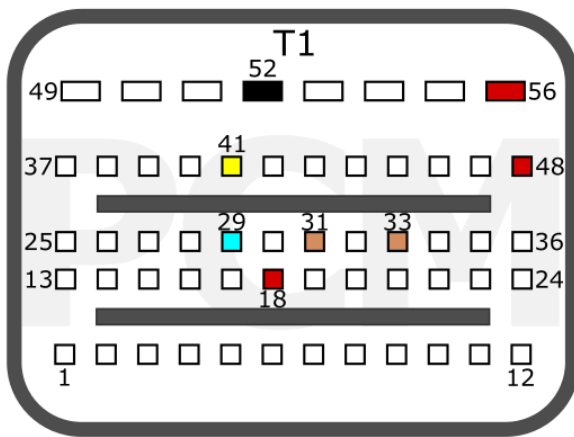

<b>+12V</b>	T1: 56, 48, 18	<b>CAN-L</b>	T1: 29
<b>GND</b>	T1: 52	<b>CAN-H</b>	T1: 41
<b>GPT</b>	T1: 31, 33		

K/H

pcmflash.ru

v.2

2023-12-16

# PCMflash

Engine Control Unit

## MED17.9.30 TC1793

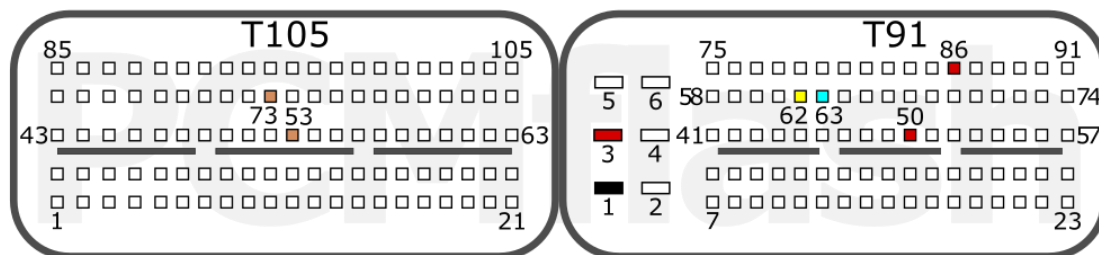

<b>+12V</b>	T91: 3, 50, 86	<b>CAN-L</b>	T91: 63
<b>GND</b>	T91: 1	<b>CAN-H</b>	T91: 62
<b>GPT</b>	T105: 73, 53		

K/H

pcmflash.ru

v.1

2024-03-06

# PCMflash

Engine Control Unit

## ME17.9.51 TC1762

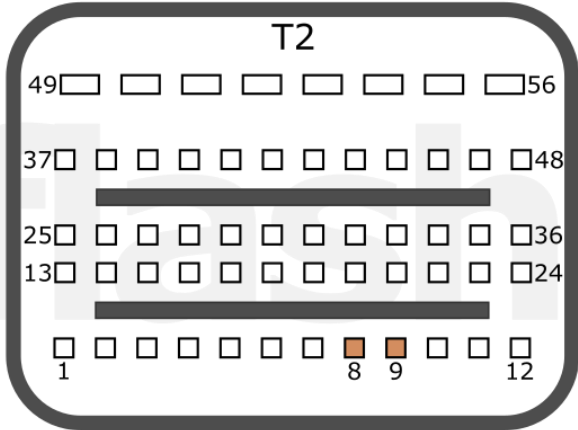
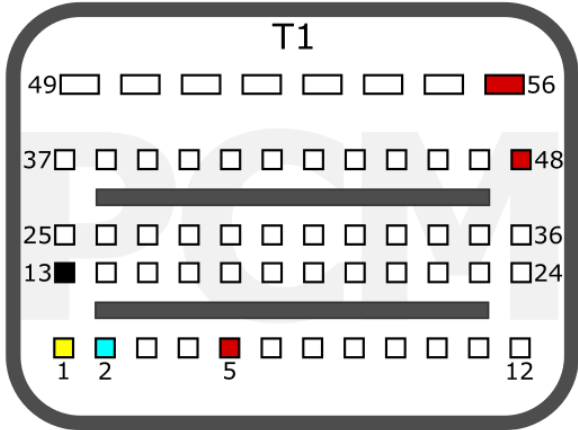

<b>+12V</b>	T1: 56, 48, 5	<b>CAN-L</b>	T1: 2
<b>GND</b>	T1: 13	<b>CAN-H</b>	T1: 1
<b>GPT</b>	T2: 9, 8		

SUZUKI

# PCMflash

Engine Control Unit

ME17.9.52 TC1782

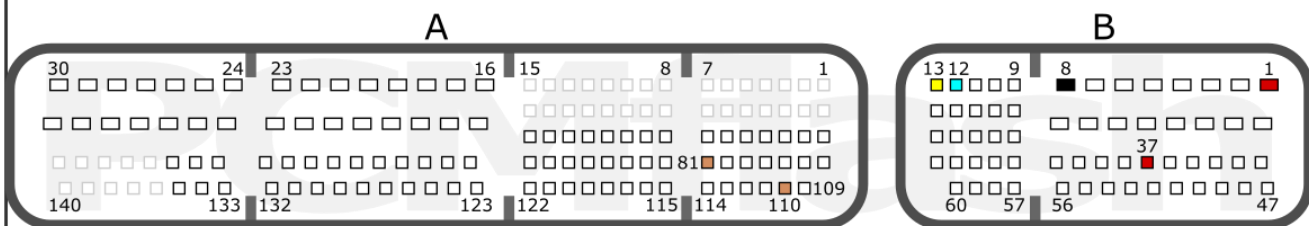

<b>+12V</b>	B: 1, 37	<b>CAN-L</b>	B: 12
<b>GND</b>	B: 8	<b>CAN-H</b>	B: 13
<b>GPT</b>	A: 110, 81		

TOYOTA

pcmflash.ru

v.1

2023-11-06

# PCMflash

Engine Control Unit

## ME17.9.55 TC1724

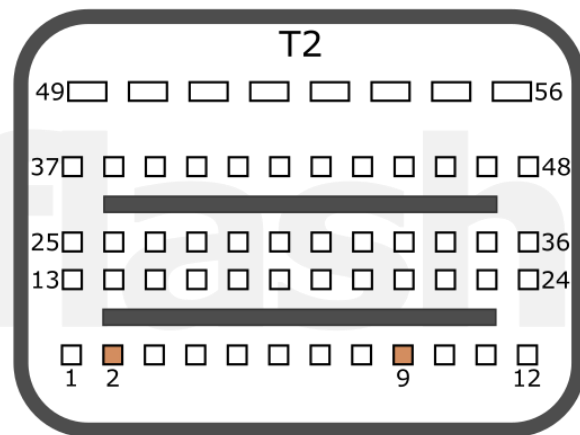
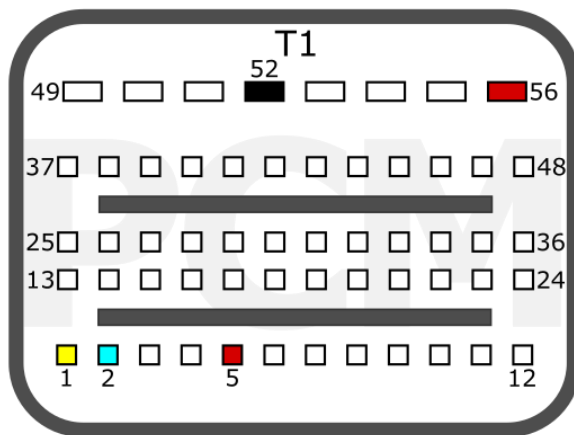

<b>+12V</b>	T1: 56, 5	<b>CAN-L</b>	T1: 2
<b>GND</b>	T1: 52	<b>CAN-H</b>	T1: 1
<b>GPT</b>	T2: 9, 2		

HONDA

PERODUA

pcmflash.ru

v.1

2022-09-01

# PCMflash

Engine Control Unit

## ME17.9.61 TC1724

### Connection version 1

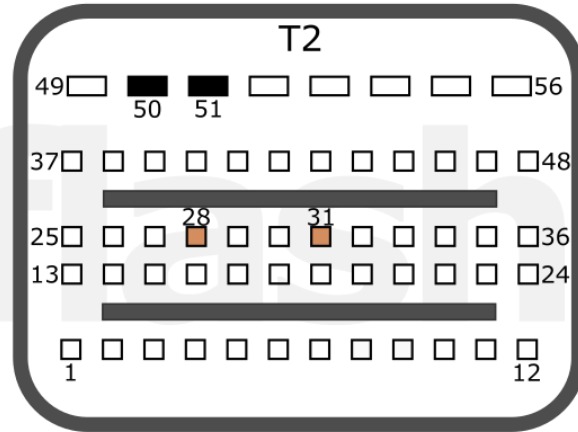
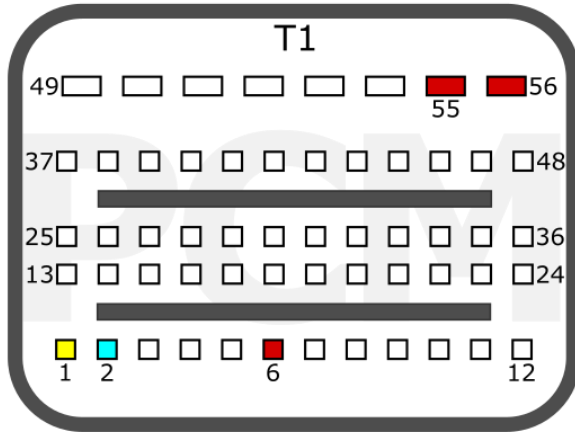

<b>+12V</b>	T1: 55, 56, 6	<b>CAN-L</b>	T1: 2
<b>GND</b>	T2: 50, 51	<b>CAN-H</b>	T1: 1
<b>GPT</b>	T2: 28, 31		

### Connection version 2

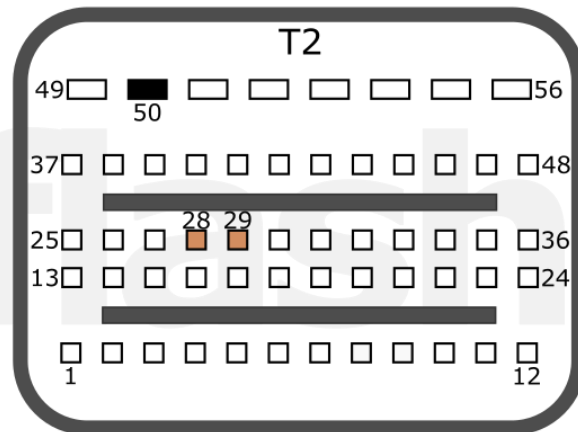
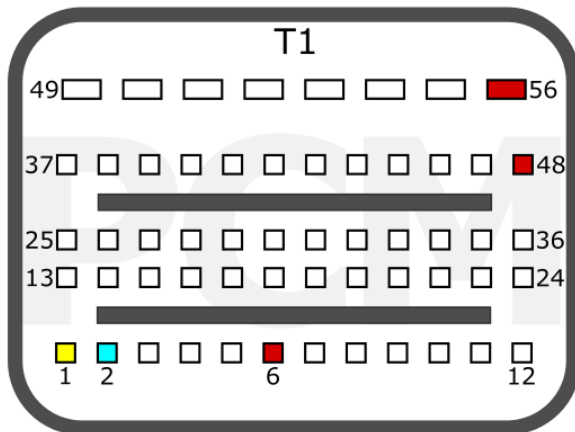

<b>+12V</b>	T1: 56, 48, 6	<b>CAN-L</b>	T1: 2
<b>GND</b>	T2: 50	<b>CAN-H</b>	T1: 1
<b>GPT</b>	T2: 29, 28		

SUZUKI

pcmflash.ru

v.1

2021-09-28

# PCMflash

Engine Control Unit

## MED17.9.63 TC1793

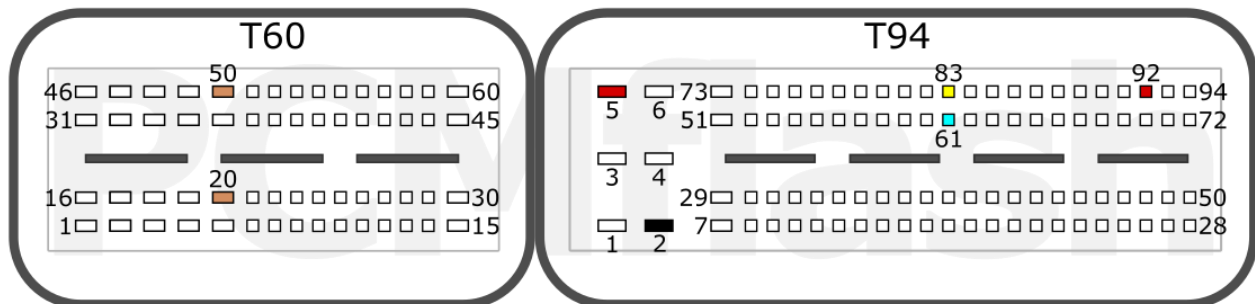

<b>+12V</b>	T94: 5, 92	<b>CAN-L</b>	T94: 61
<b>GND</b>	T94: 2	<b>CAN-H</b>	T94: 83
<b>GPT</b>	T60: 20, 50		

SUZUKI

pcmflash.ru

v.1

2021-12-03



# PCMflash

Engine Control Unit

## ME17.9.64 TC1724

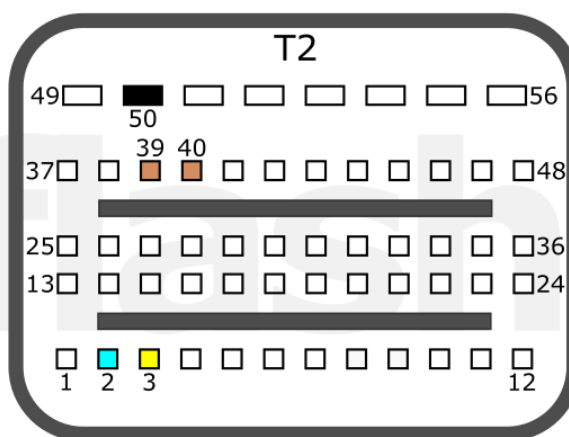
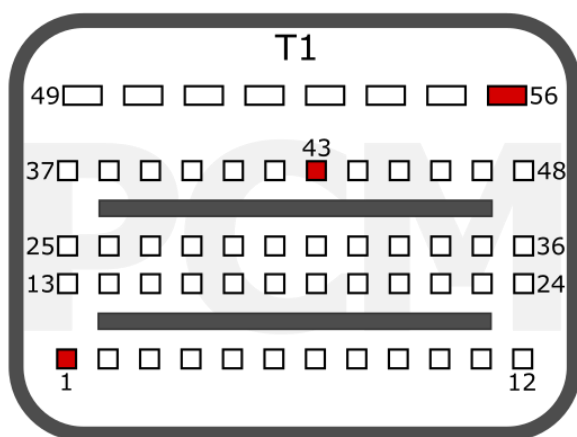

<b>+12V</b>	T1: 1, 43, 56	<b>CAN-L</b>	T2: 2
<b>GND</b>	T2: 50	<b>CAN-H</b>	T2: 3
<b>GPT</b>	T2: 39, 40		

SUZUKI

pcmflash.ru

v.1

2021-12-06

# PCMflash

Engine Control Unit

## ME17.9.71 TC1724

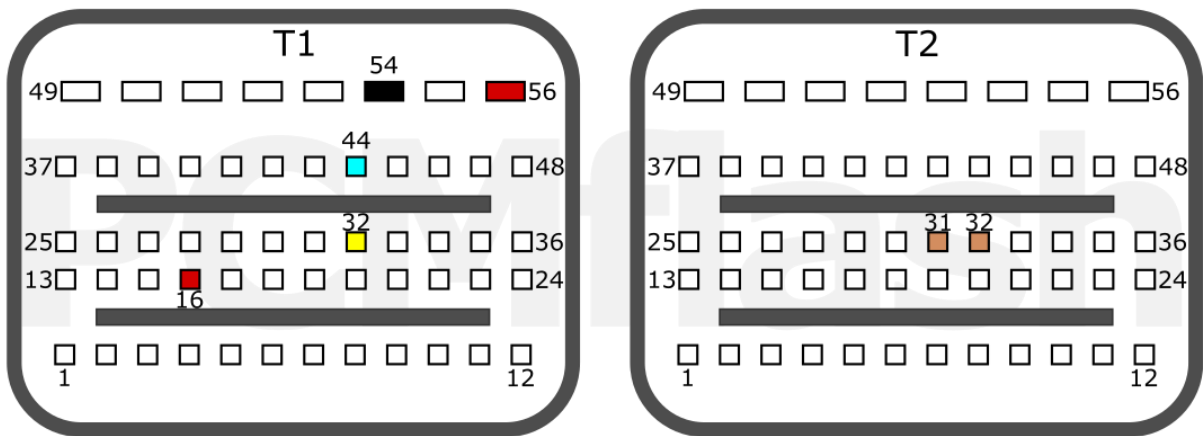

<b>+12V</b>	T1: 56, 16	<b>CAN-L</b>	T1: 44
<b>GND</b>	T1: 54	<b>CAN-H</b>	T1: 32
<b>GPT</b>	T2: 31, 32		

To unlock, read the stock and write it down.  
When recording, check the "unlock" box.

NIVA

UAZ

pcmflash.ru

v.1

2021-08-29

# PCMflash

Engine Control Unit

ME17.9.74 TC1762

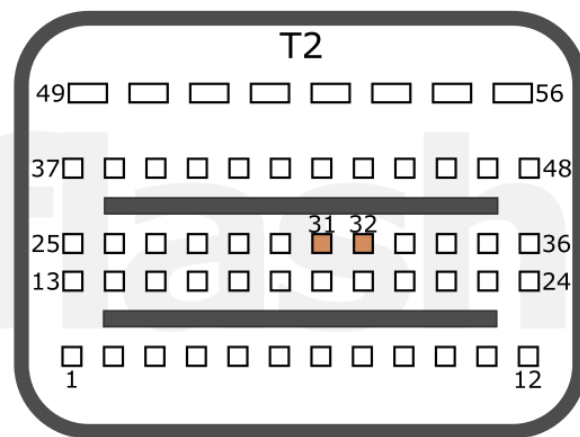
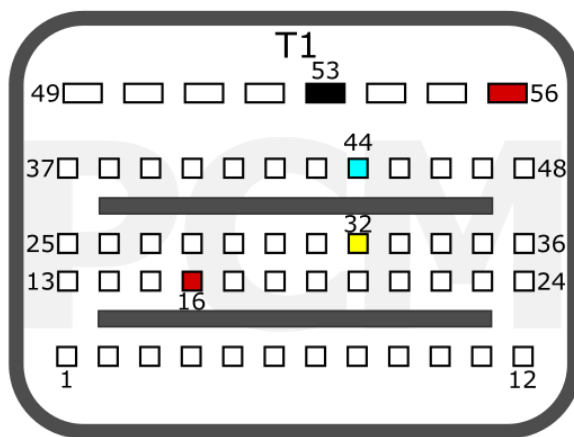

<b>+12V</b>	T1: 56, 16	<b>CAN-L</b>	T1: 44
<b>GND</b>	T1: 53	<b>CAN-H</b>	T1: 32
<b>GPT</b>	T2: 32, 31		

POLARIS

pcmflash.ru

v.1

2023-08-12

# PCMflash

Engine Control Unit

## EDC17C06 TC1766

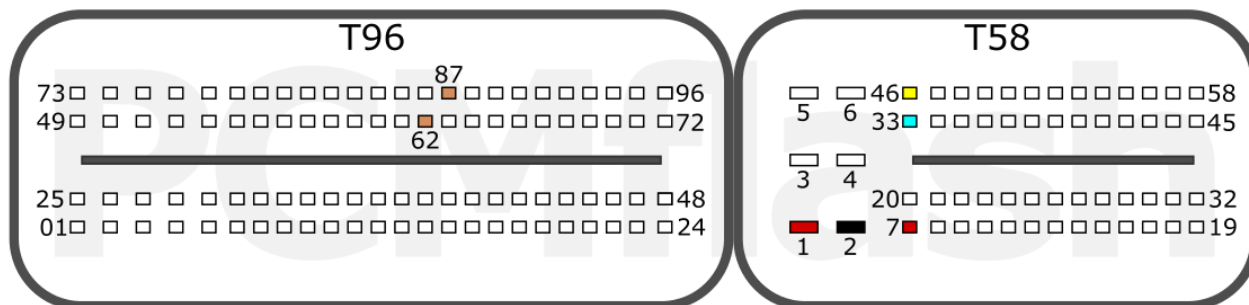

<b>+12V</b>	T58: 1, 7	<b>CAN-L</b>	T58: 33
<b>GND</b>	T58: 2	<b>CAN-H</b>	T58: 46
<b>GPT</b>	T96: 62, 87		

BMW

pcmflash.ru

v.1

2021-09-25

# PCMflash

Engine Control Unit

## EDC17C08 TC1766

### Connection version 1

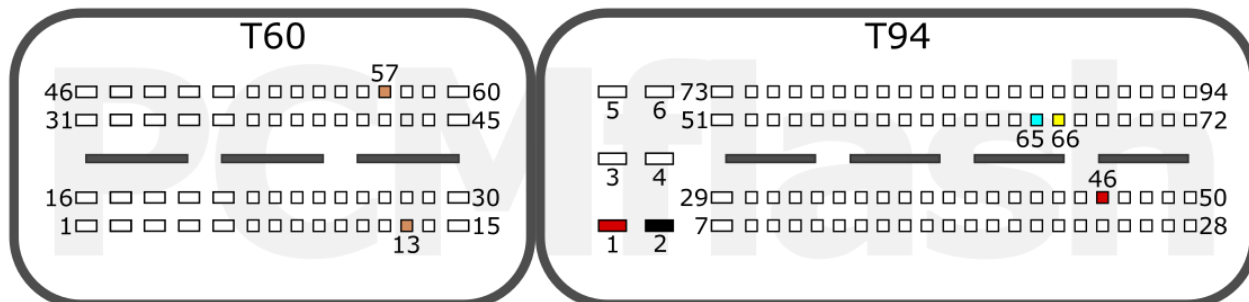

<b>+12V</b>	T94: 1, 46	<b>CAN-L</b>	T94: 65
<b>GND</b>	T94: 2	<b>CAN-H</b>	T94: 66
<b>GPT</b>	T60: 13, 57		

### Connection version 2

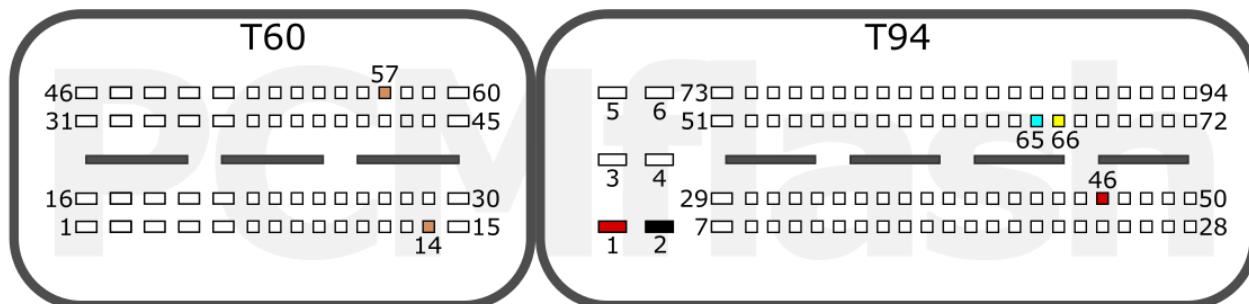

<b>+12V</b>	T94: 1, 46	<b>CAN-L</b>	T94: 65
<b>GND</b>	T94: 2	<b>CAN-H</b>	T94: 66
<b>GPT</b>	T60: 14, 57		

K/H

# PCMflash

Engine Control Unit

## EDC17C10 TC1797

### PSA

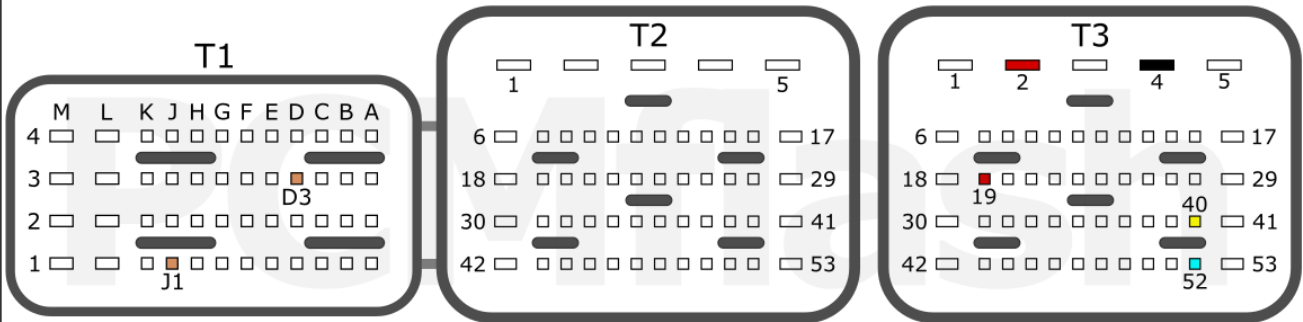

<b>+12V</b>	T3: 2, 19	<b>CAN-L</b>	T3: 52
<b>GND</b>	T3: 4	<b>CAN-H</b>	T3: 40
<b>GPT</b>	T1: J1, D3		

### FORD

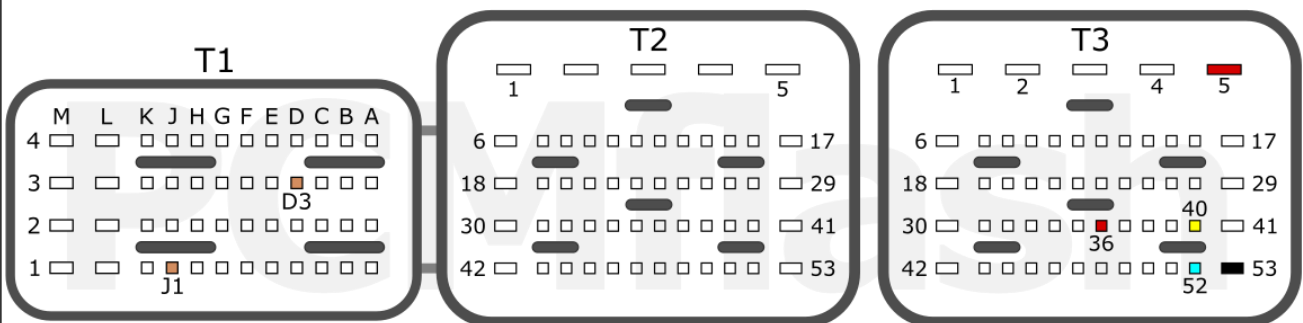

<b>+12V</b>	T3: 5, 36	<b>CAN-L</b>	T3: 52
<b>GND</b>	T3: 53	<b>CAN-H</b>	T3: 40
<b>GPT</b>	T1: J1, D3		

FORD

PSA

pcmflash.ru

v.2

2021-10-11

# PCMflash

Engine Control Unit

## EDC17C11 TC1766

### Connection version 1

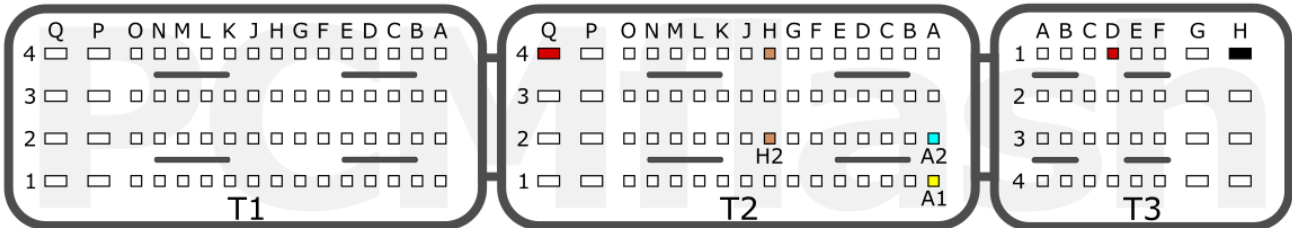

<b>+12V</b>	T2: Q4, T3:D1	<b>CAN-L</b>	T2: A2
<b>GND</b>	T3: H1	<b>CAN-H</b>	T2: A1
<b>GPT</b>	T2: H2, H4		

### Connection version 2

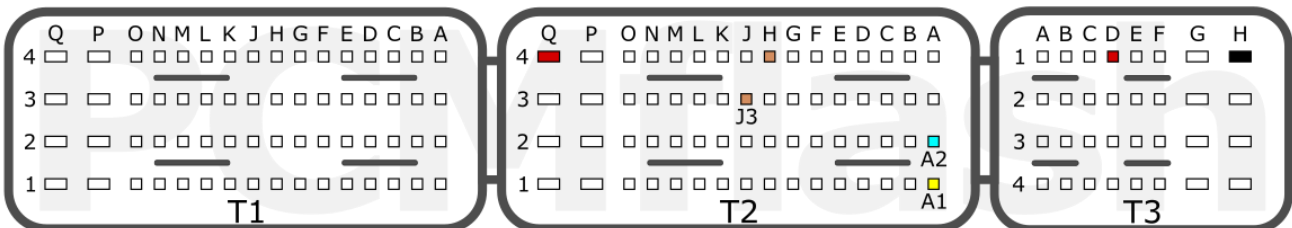

<b>+12V</b>	T2: Q4, T3:D1	<b>CAN-L</b>	T2: A2
<b>GND</b>	T3: H1	<b>CAN-H</b>	T2: A1
<b>GPT</b>	T2: H4, J3		

NISSAN

OPEL

RENAULT

pcmflash.ru

v.1

2021-09-29

# PCMflash

Engine Control Unit

## EDC17C18 TC1766

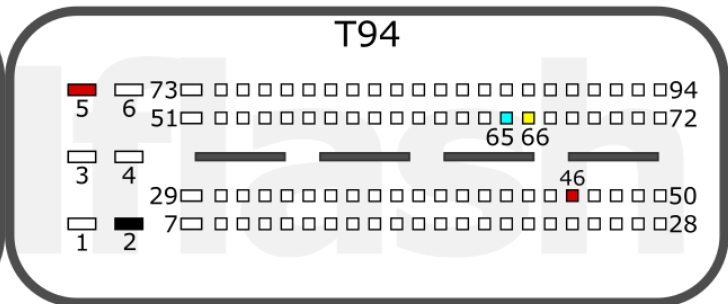
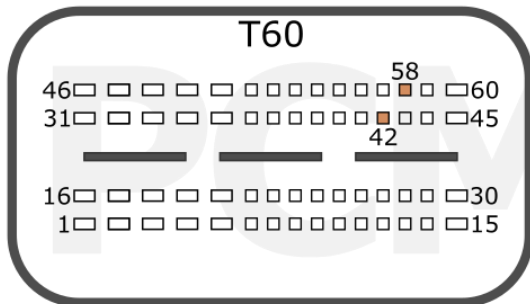

<b>+12V</b>	T94: 5, 46	<b>CAN-L</b>	T94: 65
<b>GND</b>	T94: 2	<b>CAN-H</b>	T94: 66
<b>GPT</b>	T60: 42, 58		

OPEL

pcmflash.ru

v.1

2021-09-30



# PCMflash

Engine Control Unit

## EDC17C19 TC1792

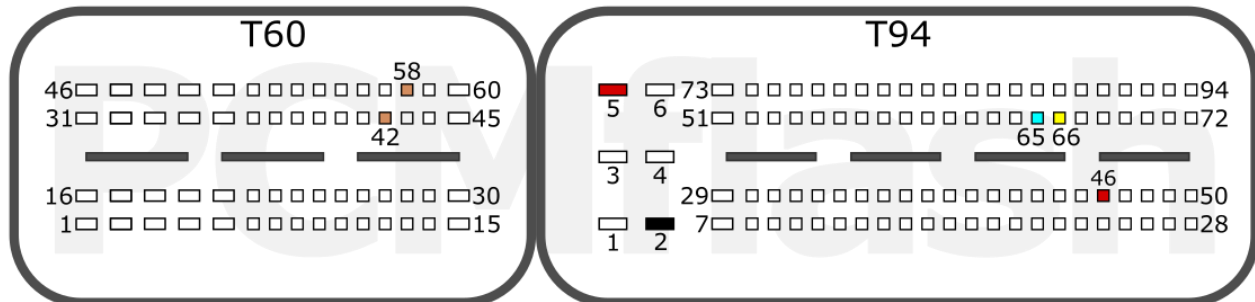

<b>+12V</b>	T94: 5, 46	<b>CAN-L</b>	T94: 65
<b>GND</b>	T94: 2	<b>CAN-H</b>	T94: 66
<b>GPT</b>	T60: 42, 58		

OPEL

pcmflash.ru

v.1

2021-09-25

# PCMflash

Engine Control Unit

## EDC17C41 TC1797

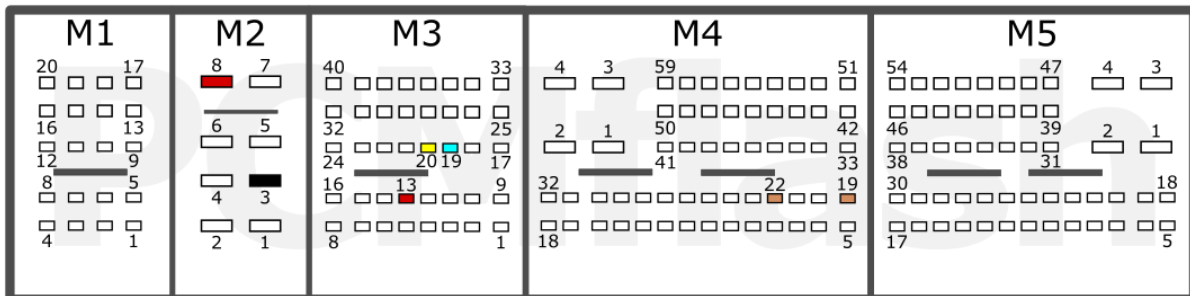

<b>+12V</b>	M2: 8; M3: 13	<b>CAN-L</b>	M3: 19
<b>GND</b>	M2: 3	<b>CAN-H</b>	M3: 20
<b>GPT</b>	M4: 22, 19		

BMW

pcmflash.ru

v.1

2022-01-24

# PCMflash

Engine Control Unit

## EDC17C42 TC1767

### Connection version 1

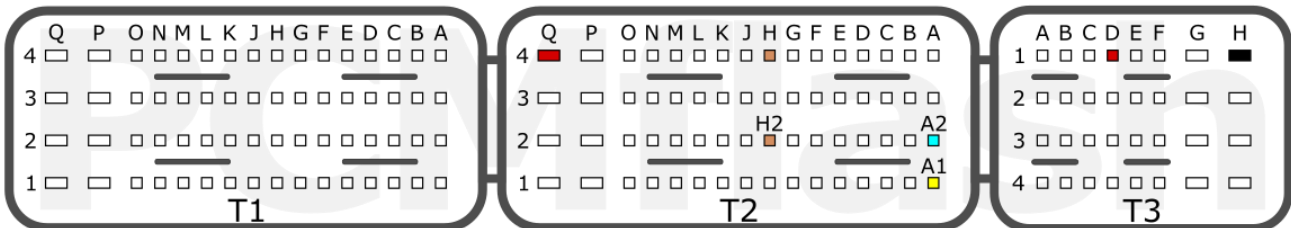

<b>+12V</b>	T2: Q4, T3:D1	<b>CAN-L</b>	T2: A2
<b>GND</b>	T3: H1	<b>CAN-H</b>	T2: A1
<b>GPT</b>	T2: H2, H4		

### Connection version 2

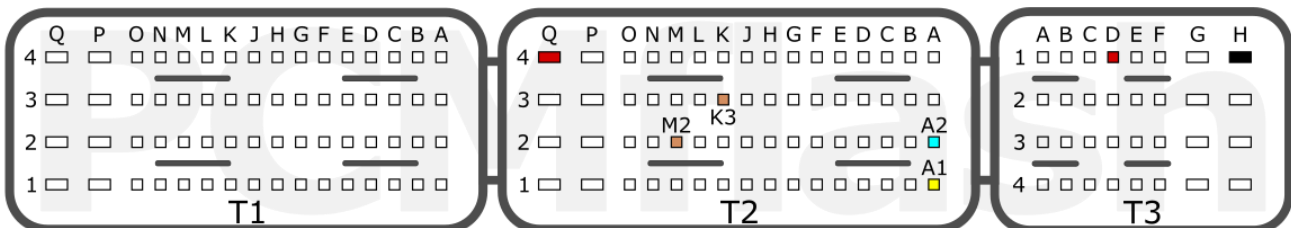

<b>+12V</b>	T2: Q4, T3:D1	<b>CAN-L</b>	T2: A2
<b>GND</b>	T3: H1	<b>CAN-H</b>	T2: A1
<b>GPT</b>	T2: M2, K3		

### Connection version 3

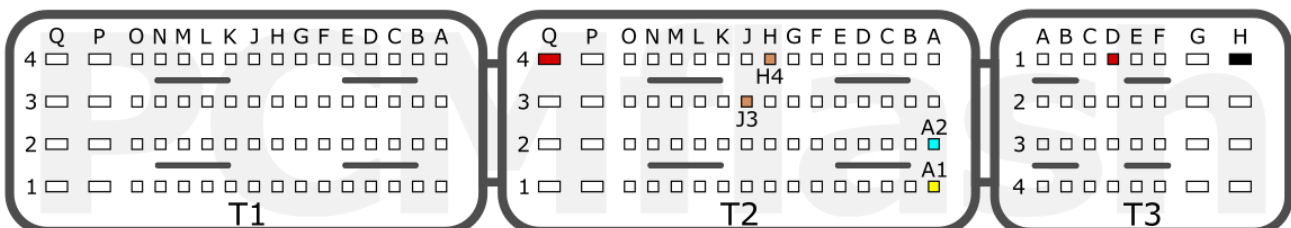

<b>+12V</b>	T2: Q4, T3:D1	<b>CAN-L</b>	T2: A2
<b>GND</b>	T3: H1	<b>CAN-H</b>	T2: A1
<b>GPT</b>	T2: H4, J3		

RENAULT

pcmflash.ru

v.3

2024-03-06

# PCMflash

Engine Control Unit

EDC17C43 TC1797

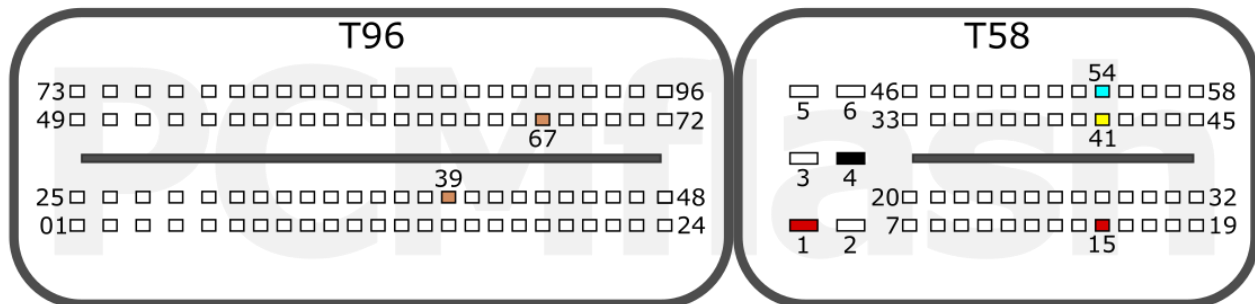

<b>+12V</b>	T58: 1, 15	<b>CAN-L</b>	T58: 54
<b>GND</b>	T58: 4	<b>CAN-H</b>	T58: 41
<b>GPT</b>	T96: 39, 67		

MB

pcmflash.ru

v.1

2022-31-03

# PCMflash

Engine Control Unit

## EDC17C45 TC1767



<b>+12V</b>	T58: 5, 56, 19	<b>CAN-L</b>	T58: 50
<b>GND</b>	T58: 2	<b>CAN-H</b>	T58: 49
<b>GPT</b>	T96: 67, T58:11		

NISSAN

pcmflash.ru

v.1

2021-12-08

# PCMflash

Engine Control Unit

## EDC17C46 TC1767

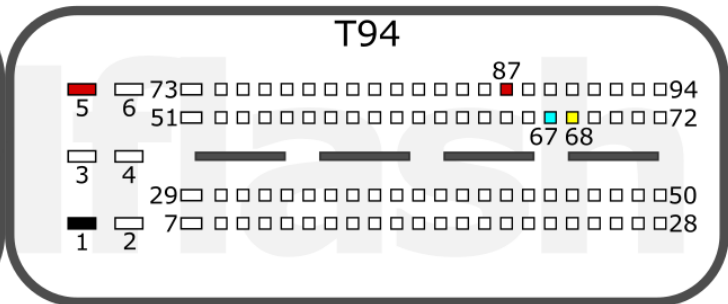
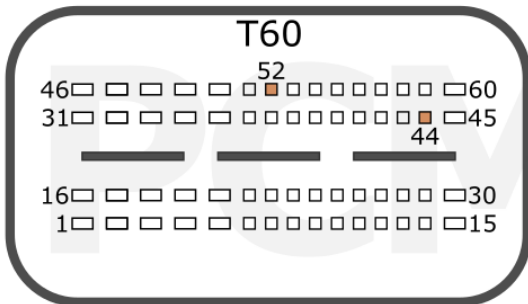

<b>+12V</b>	T94: 5, 87	<b>CAN-L</b>	T94: 67
<b>GND</b>	T94: 1	<b>CAN-H</b>	T94: 68
<b>GPT</b>	T60: 44, 52		

VAG

pcmflash.ru

v.1

2021-08-25

# PCMflash

Engine Control Unit

## EDC17C47 TC1782

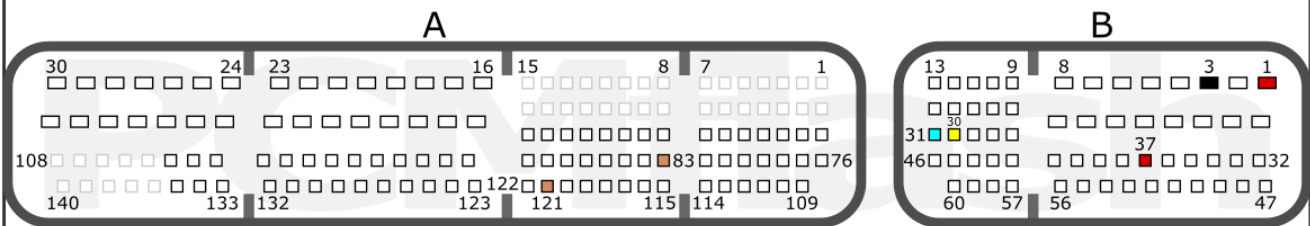

<b>+12V</b>	B: 1, 37	<b>CAN-L</b>	B: 31
<b>GND</b>	B: 3	<b>CAN-H</b>	B: 30
<b>GPT</b>	A: 83, 121		

TOYOTA

pcmflash.ru

v.1

2022-06-15

# PCMflash

Engine Control Unit

## EDC17C49 TC1797

### Connection version 1

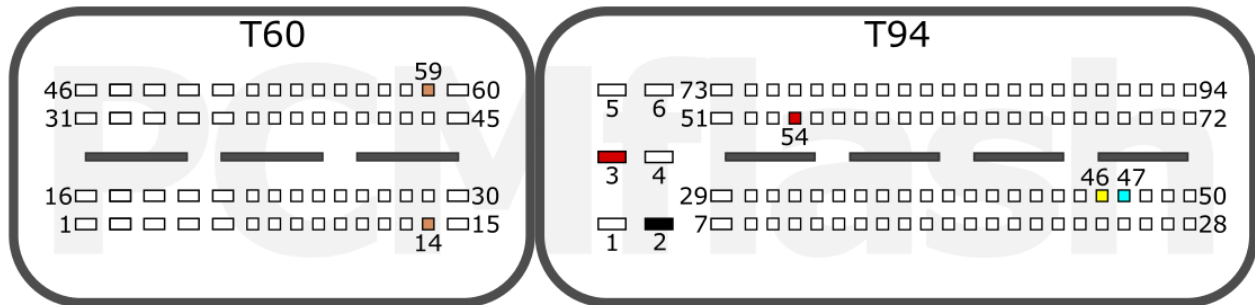

<b>+12V</b>	T94: 3, 54	<b>CAN-L</b>	T94: 47
<b>GND</b>	T94: 2	<b>CAN-H</b>	T94: 46
<b>GPT</b>	T60: 14, 59		

### Connection version 2

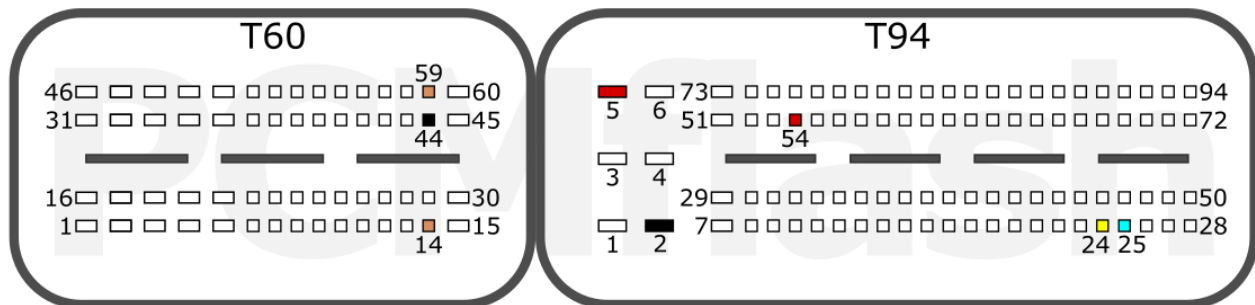

<b>+12V</b>	T94: 5, 54	<b>CAN-L</b>	T94: 25
<b>GND</b>	T60: 44, T94: 2	<b>CAN-H</b>	T94: 24
<b>GPT</b>	T60: 14, 59*		

\*10-47 uF 50v capacitor required on 59 GPT line /  
Подключить сигнал 59 GPT к ЭБУ через конденсатор 10-47 мкФ

### Connection version 3

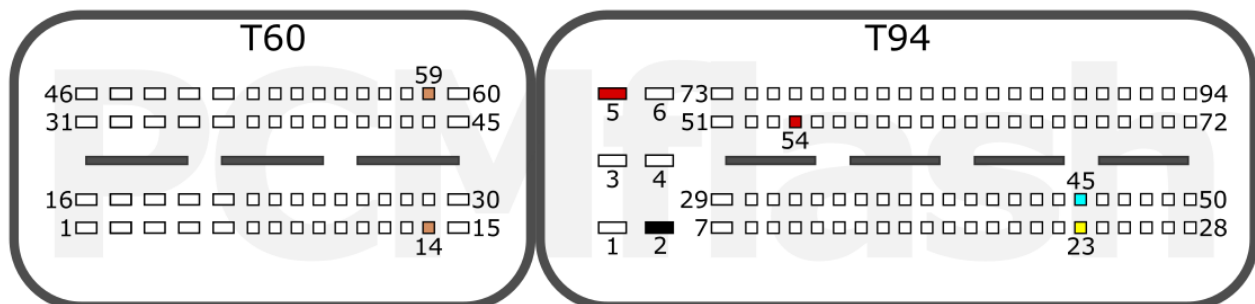

<b>+12V</b>	T94: 5, 54	<b>CAN-L</b>	T94: 45
<b>GND</b>	T94: 2	<b>CAN-H</b>	T94: 23
<b>GPT</b>	T60: 59, 14		

FIAT

JEEP

IVECO

OPEL

pcmflash.ru

v.3

2023-03-27



# PCMflash

Engine Control Unit

## EDC17C50 TC1797

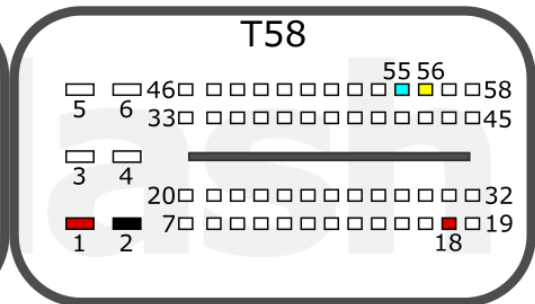

<b>+12V</b>	T58: 1, 18	<b>CAN-L</b>	T58: 55
<b>GND</b>	T58: 2	<b>CAN-H</b>	T58: 56
<b>GPT</b>	T96: 89, 92		

BMW

pcmflash.ru

v.1

2021-09-11

# PCMflash

Engine Control Unit

## EDC17C53 TC1767

### Connection version 1

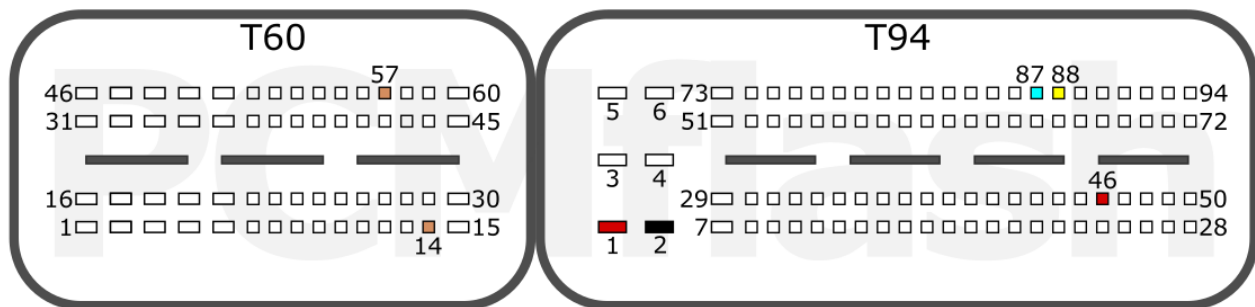

<b>+12V</b>	T94: 1, 46	<b>CAN-L</b>	T94: 87
<b>GND</b>	T94: 2	<b>CAN-H</b>	T94: 88
<b>GPT</b>	T60: 14, 57		

### Connection version 2

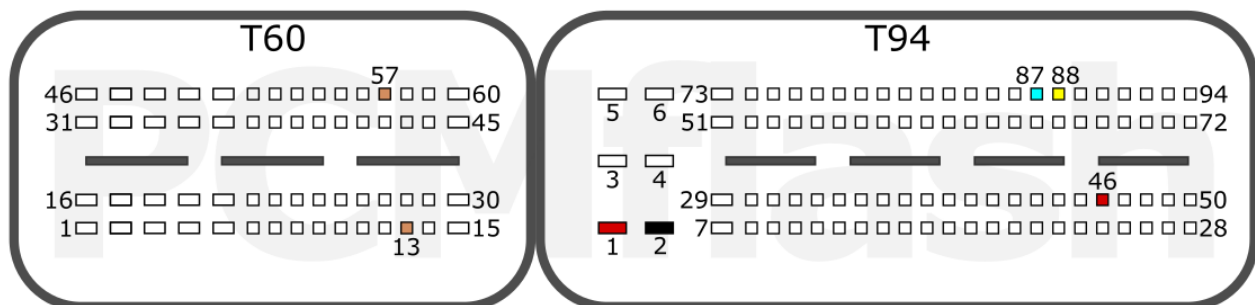

<b>+12V</b>	T94: 1, 46	<b>CAN-L</b>	T94: 87
<b>GND</b>	T94: 2	<b>CAN-H</b>	T94: 88
<b>GPT</b>	T60: 13, 57		

HAVAL

JAC

K/H

pcmflash.ru

v.2

2022-12-20

# PCMflash

Engine Control Unit

## EDC17C54 TC1797

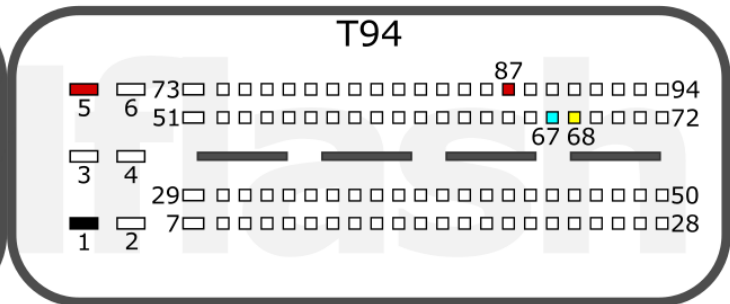
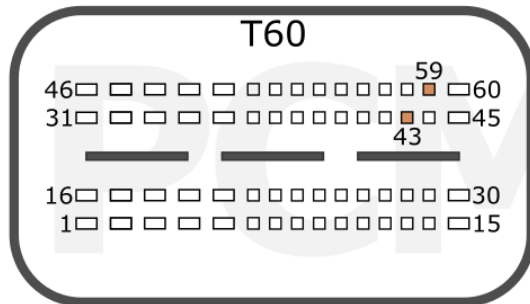

<b>+12V</b>	T94: 5, 87	<b>CAN-L</b>	T94: 67
<b>GND</b>	T94: 1	<b>CAN-H</b>	T94: 68
<b>GPT</b>	T60: 43, 59		

VAG

pcmflash.ru

v.1

2021-08-29

# PCMflash

Engine Control Unit

EDC17C56 TC1797

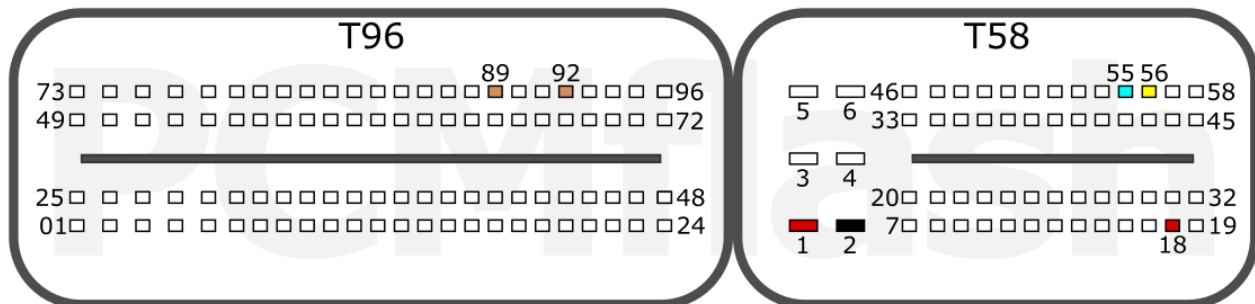

<b>+12V</b>	T58: 1, 18	<b>CAN-L</b>	T58: 55
<b>GND</b>	T58: 2	<b>CAN-H</b>	T58: 56
<b>GPT</b>	T96: 92, 89		

BMW

pcmflash.ru

v.1

2021-08-25

# PCMflash

Engine Control Unit

## EDC17C57 TC1793

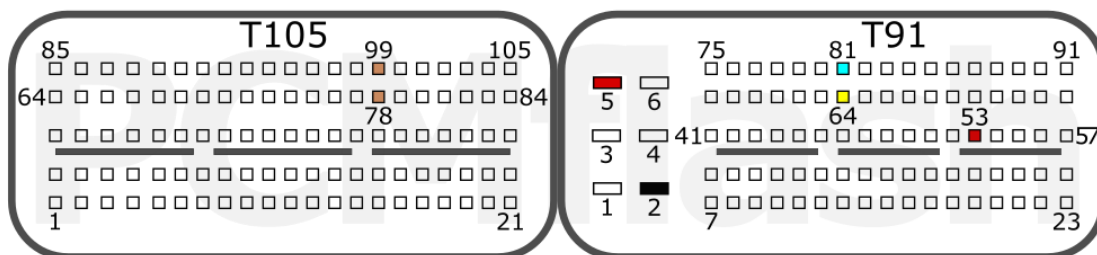

<b>+12V</b>	T91: 5, 53	<b>CAN-L</b>	T91: 81
<b>GND</b>	T91: 2	<b>CAN-H</b>	T91: 64
<b>GPT</b>	T105: 99, 78		

K/H

pcmflash.ru

v.1

2021-08-26

# PCMflash

Engine Control Unit

## EDC17C58 TC1793

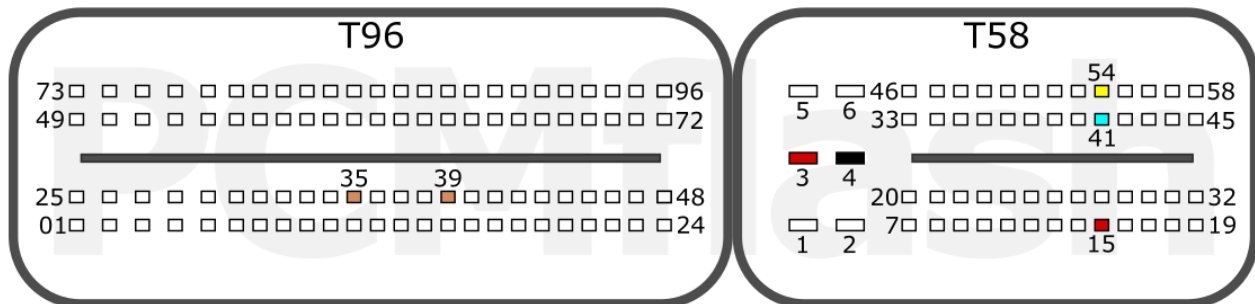

<b>+12V</b>	T58: 3, 15	<b>CAN-L</b>	T58: 41
<b>GND</b>	T58: 4	<b>CAN-H</b>	T58: 54
<b>GPT</b>	T96: 35, 39		

HONDA

pcmflash.ru

v.1

2022-04-14

# PCMflash

Engine Control Unit

## EDC17C59 TC1767

### 1.3-LITRE ENGINE

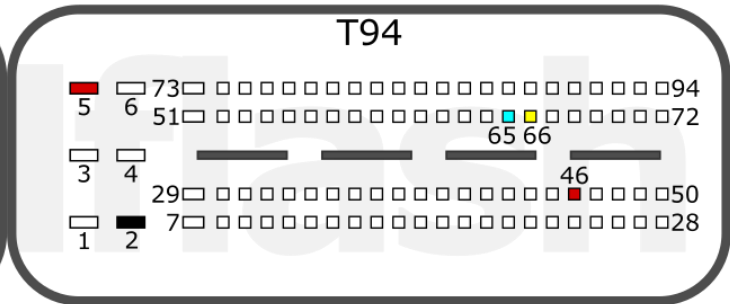
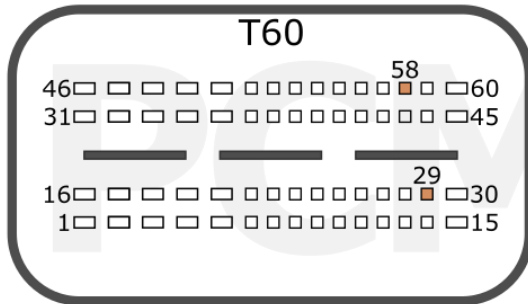

<b>+12V</b>	T94: 5, 46	<b>CAN-L</b>	T94: 65
<b>GND</b>	T94: 2	<b>CAN-H</b>	T94: 66
<b>GPT</b>	T60: 29, 58		

### 2.0-LITRE ENGINE

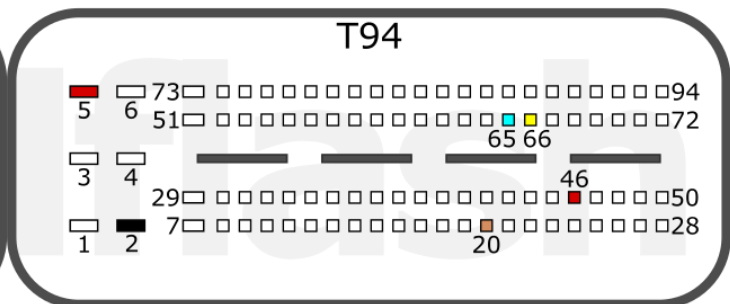
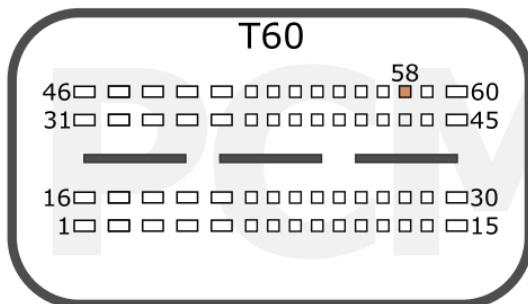

<b>+12V</b>	T94: 5, 46	<b>CAN-L</b>	T94: 65
<b>GND</b>	T94: 2	<b>CAN-H</b>	T94: 66
<b>GPT</b>	T60: 58, T94: 20		

OPEL

pcmflash.ru

v.1

2021-09-11

# PCMflash

Engine Control Unit

## EDC17C60 TC1793

### Connection version 1

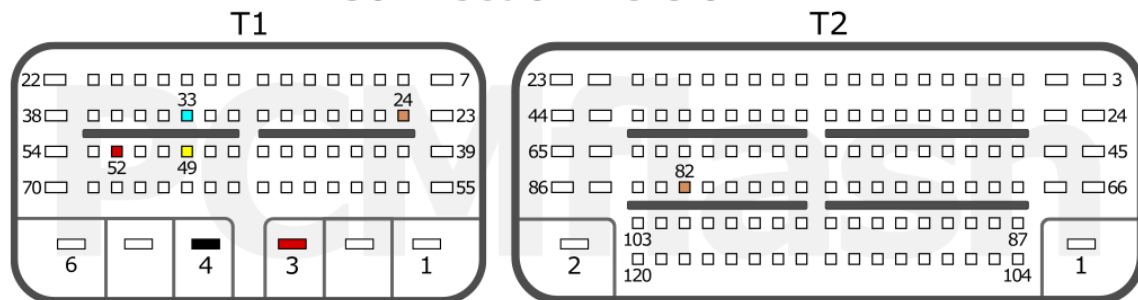

<b>+12V</b>	T1: 52, 3	<b>CAN-L</b>	T1: 33
<b>GND</b>	T1: 4	<b>CAN-H</b>	T1: 49
<b>GPT</b>	T1: 24, T2:82		

### Connection version 2

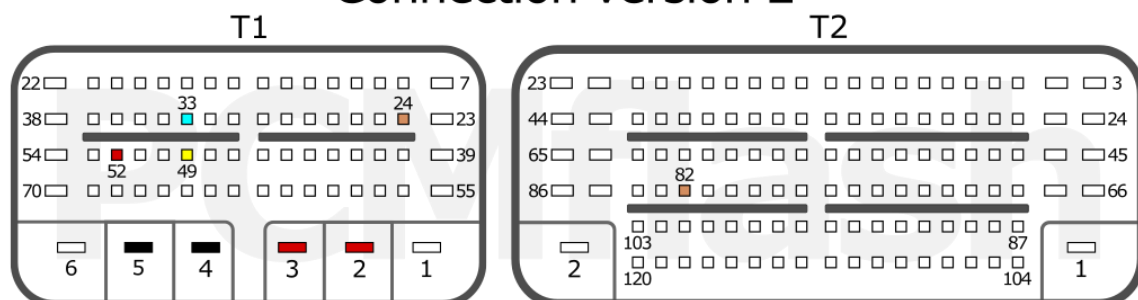

<b>+12V</b>	T1: 52, 3, 2	<b>CAN-L</b>	T1: 33
<b>GND</b>	T1: 4, 5	<b>CAN-H</b>	T1: 49
<b>GPT</b>	T1: 24, T2:82		

PSA

pcmflash.ru

v.1

2021-11-01



# PCMflash

Engine Control Unit

## EDC17C63 TC1724

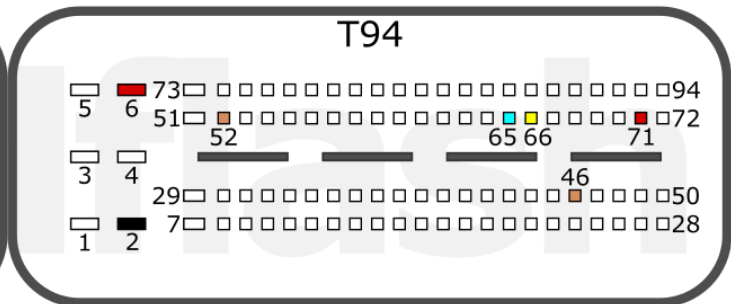
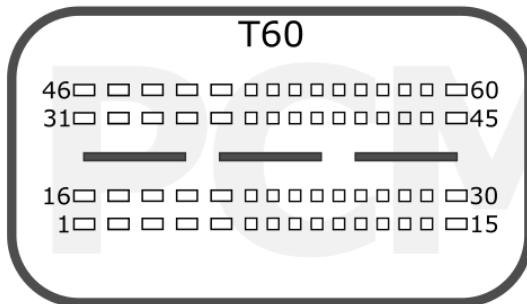

<b>+12V</b>	T94: 6, 71	<b>CAN-L</b>	T94: 65
<b>GND</b>	T94: 2	<b>CAN-H</b>	T94: 66
<b>GPT</b>	T94: 46, 52		

ISUZU

pcmflash.ru

v.1

2021-10-07



# PCMflash

Engine Control Unit

## EDC17C66 TC1793

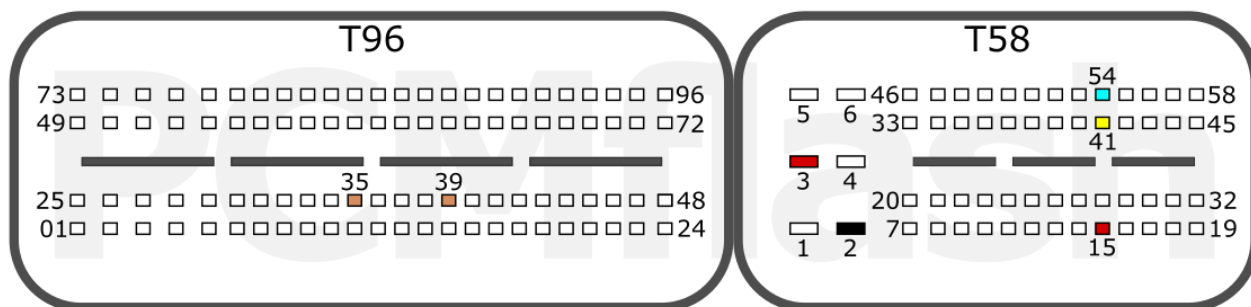

<b>+12V</b>	T58: 3, 15	<b>CAN-L</b>	T58: 54
<b>GND</b>	T58: 2	<b>CAN-H</b>	T58: 41
<b>GPT</b>	T96: 35, 39		

MB

pcmflash.ru

v.1

2021-09-09

# PCMflash

Engine Control Unit

## EDC17C69 TC1793

### Connection version 1

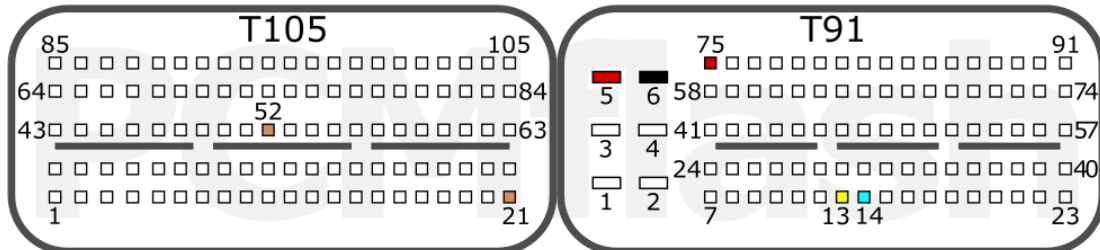

<b>+12V</b>	T91: 5, 75	<b>CAN-L</b>	T91: 14
<b>GND</b>	T91: 6	<b>CAN-H</b>	T91: 13
<b>GPT</b>	T105: 52, 21		

### Connection version 2

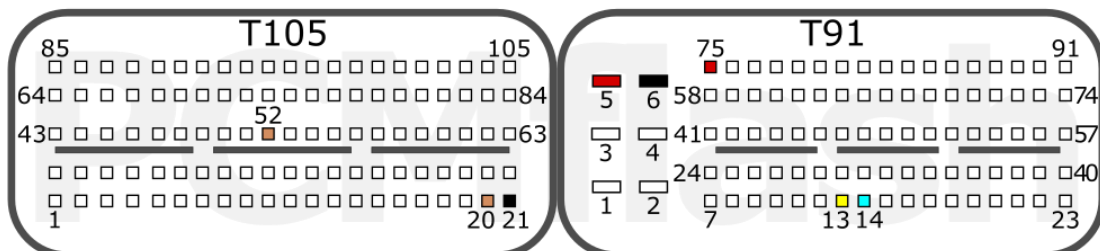

<b>+12V</b>	T91: 5, 75	<b>CAN-L</b>	T91: 14
<b>GND</b>	T105: 21, T91: 6	<b>CAN-H</b>	T91: 13
<b>GPT</b>	T105: 52, 20*		

\*Install 10uF capacitor on 20 GPT line

JEEP

IVECO

pcmflash.ru

v.2

2023-11-06

# PCMflash

Engine Control Unit

## EDC17C70 TC1793

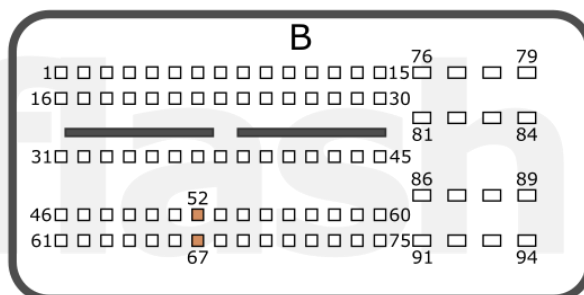
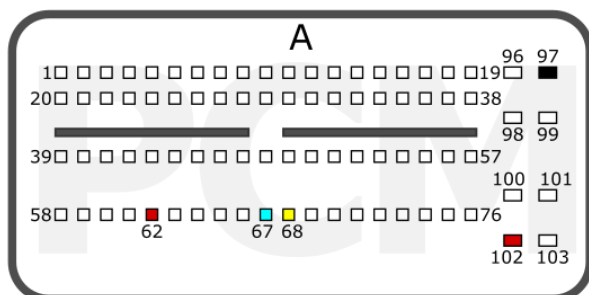

<b>+12V</b>	A: 62, 102	<b>CAN-L</b>	A: 67
<b>GND</b>	A: 97	<b>CAN-H</b>	A: 68
<b>GPT</b>	B: 67, 52		

FORD

pcmflash.ru

v.1

2021-09-08

# PCMflash

Engine Control Unit

## EDC17C73 TC1793

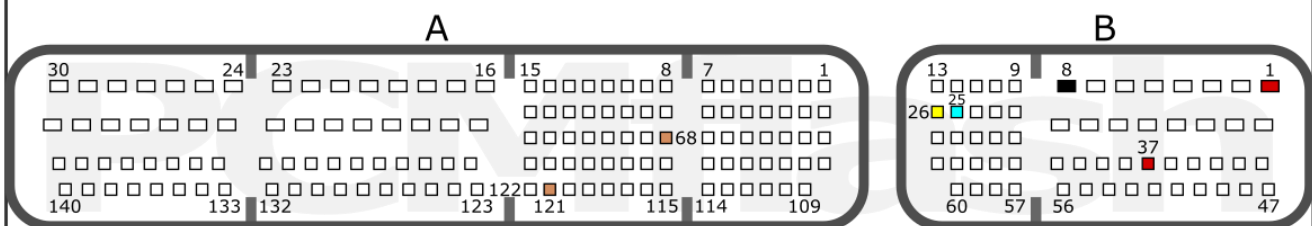

<b>+12V</b>	B: 1, 37	<b>CAN-L</b>	B: 25
<b>GND</b>	B: 8	<b>CAN-H</b>	B: 26
<b>GPT</b>	A: 68, 121		

TOYOTA

pcmflash.ru

v.1

2021-10-08

# PCMflash

Engine Control Unit

## EDC17C74 TC1793

### Connection version 1

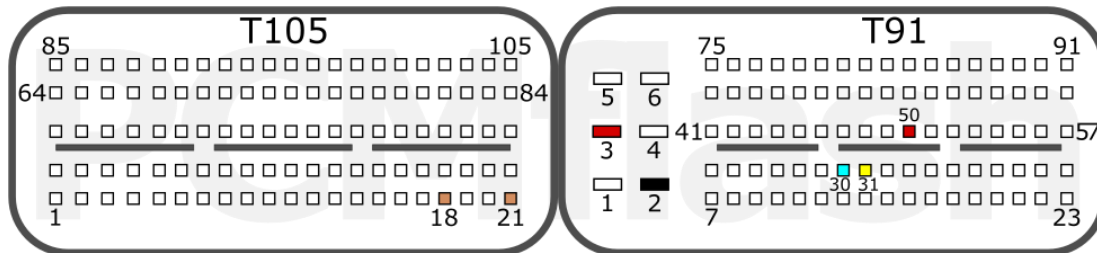

<b>+12V</b>	T91: 3, 50	<b>CAN-L</b>	T91: 30
<b>GND</b>	T91: 2	<b>CAN-H</b>	T91: 31
<b>GPT</b>	T105: 18, 21		

### Connection version 2

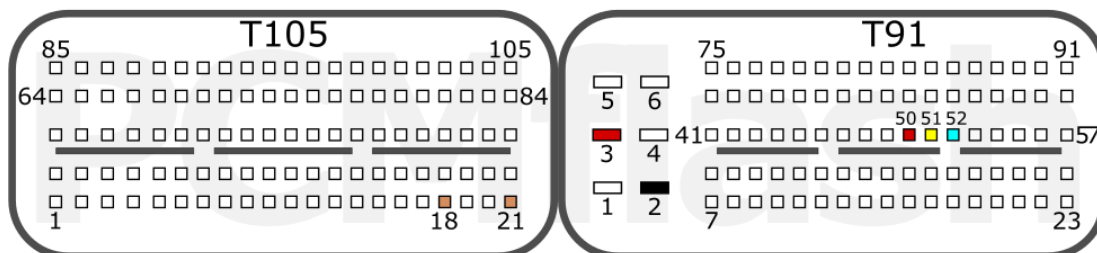

<b>+12V</b>	T91: 3, 50	<b>CAN-L</b>	T91: 52
<b>GND</b>	T91: 2	<b>CAN-H</b>	T91: 51
<b>GPT</b>	T105: 18, 21		

VAG

pcmflash.ru

v.1

2021-10-13

# PCMflash

Engine Control Unit  
**EDC17C76 TC1793**



<b>+12V</b>	T58: 1, 18	<b>CAN-L</b>	T58: 55
<b>GND</b>	T58: 2	<b>CAN-H</b>	T58: 56
<b>GPT</b>	T96: 92, 89		

BMW

pcmflash.ru

v.1

2023-04-01



# PCMflash

Engine Control Unit

## EDC17C79 TC1797

### Connection version 1

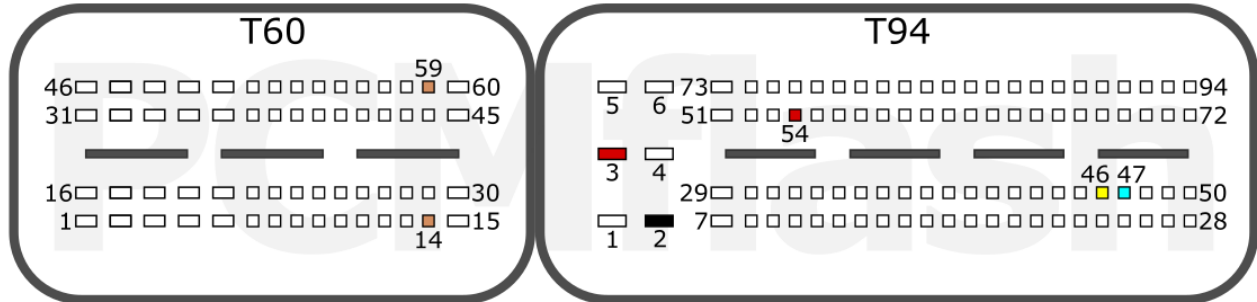

<b>+12V</b>	T94: 3, 54	<b>CAN-L</b>	T94: 47
<b>GND</b>	T94: 2	<b>CAN-H</b>	T94: 46
<b>GPT</b>	T60: 14, 59		

### Connection version 2

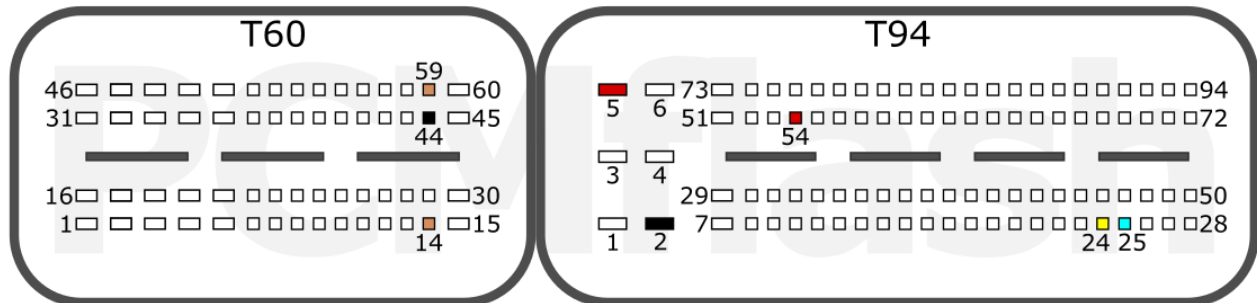

<b>+12V</b>	T94: 5, 54	<b>CAN-L</b>	T94: 25
<b>GND</b>	T60: 44, T94: 2	<b>CAN-H</b>	T94: 24
<b>GPT</b>	T60: 14, 59*		

\*10-47 uF 50v capacitor required on 59 GPT line /  
Подключить сигнал 59 GPT к ЭБУ через конденсатор 10-47 мкФ

### Connection version 3

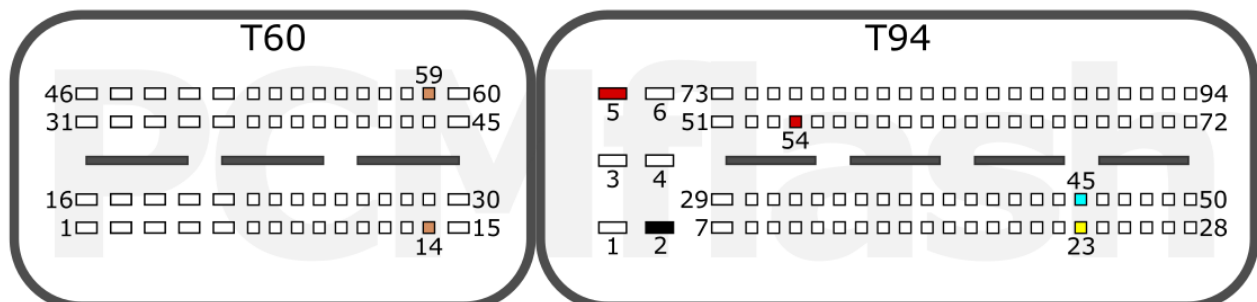

<b>+12V</b>	T94: 5, 54	<b>CAN-L</b>	T94: 45
<b>GND</b>	T94: 2	<b>CAN-H</b>	T94: 23
<b>GPT</b>	T60: 59, 14		

DODGE

JEEP

IVECO

MASERATI

pcmflash.ru

v.4

2023-03-23

# PCMflash

Engine Control Unit

## EDC17C81 TC1782

### Connection version 1

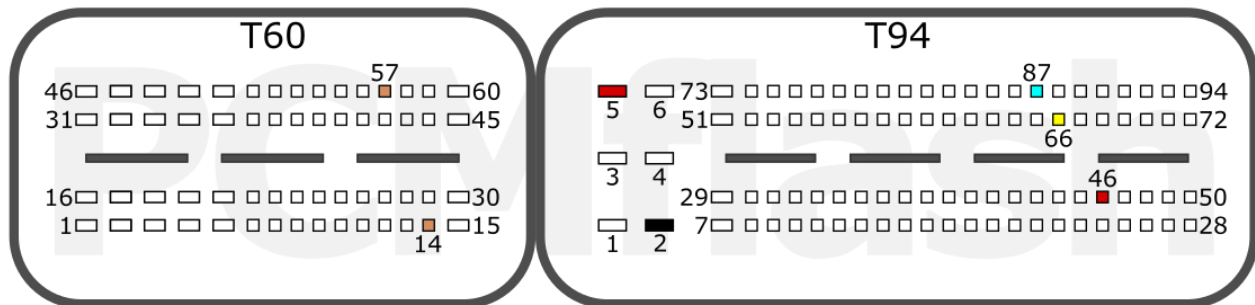

<b>+12V</b>	T94: 5, 46	<b>CAN-L</b>	T94: 87
<b>GND</b>	T94: 2	<b>CAN-H</b>	T94: 66
<b>GPT</b>	T60: 14, 57		

### Connection version 2

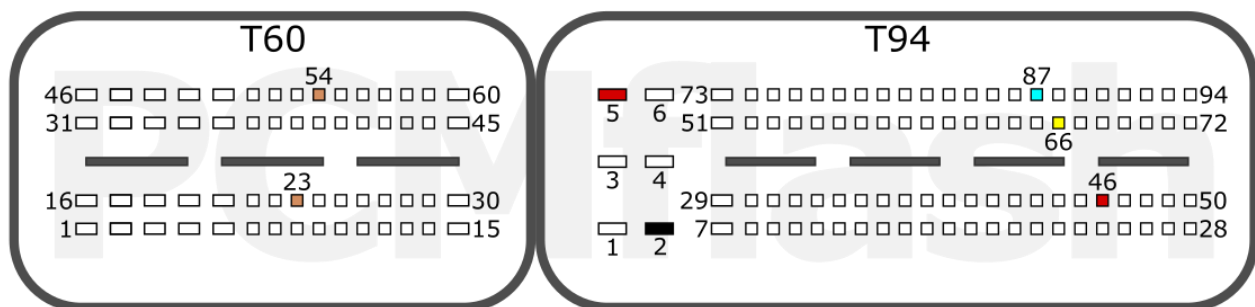

<b>+12V</b>	T94: 5, 46	<b>CAN-L</b>	T94: 87
<b>GND</b>	T94: 2	<b>CAN-H</b>	T94: 66
<b>GPT</b>	T60: 23, 54		

### TRUCKS

pcmflash.ru

v.2

2024-04-10

# PCMflash

Engine Control Unit

## EDC17C83 TC1793

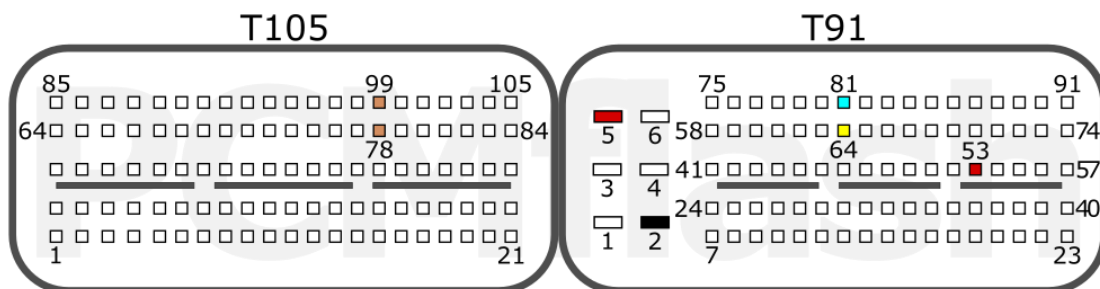

<b>+12V</b>	T91: 5, 53	<b>CAN-L</b>	T91: 81
<b>GND</b>	T91: 2	<b>CAN-H</b>	T91: 64
<b>GPT</b>	T105: 78, 99		

ISUZU

pcmflash.ru

v.1

2021-10-16

# PCMflash

Engine Control Unit

## EDC17C84 TC1782

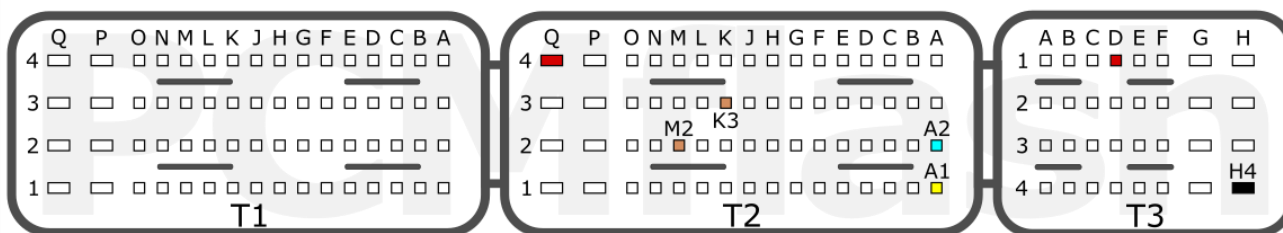

<b>+12V</b>	T2: Q4, T3: D1	<b>CAN-L</b>	T2: A2
<b>GND</b>	T3: H4	<b>CAN-H</b>	T2: A1
<b>GPT</b>	T2: M2, K3		

NISSAN

OPEL

RENAULT

pcmflash.ru

v.1

2021-10-15

# PCMflash

Engine Control Unit

EDC17CP01 TC1796



<b>+12V</b>	T58: 3, 15	<b>CAN-L</b>	T58: 41
<b>GND</b>	T58: 2	<b>CAN-H</b>	T58: 54
<b>GPT</b>	T96: 35, 39		

MB

pcmflash.ru

v.1

2021-10-07

# PCMflash

Engine Control Unit

## EDC17CP02 TC1766

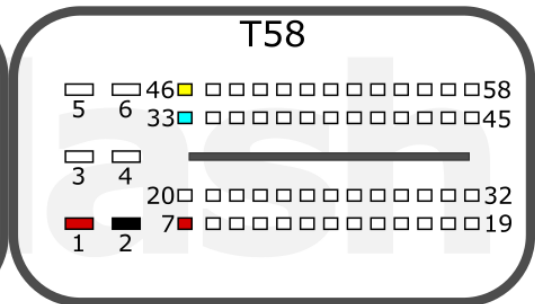

<b>+12V</b>	T58: 1, 7	<b>CAN-L</b>	T58: 33
<b>GND</b>	T58: 2	<b>CAN-H</b>	T58: 46
<b>GPT</b>	T96: 62, 87		

BMW

pcmflash.ru

v.1

2021-09-04

# PCMflash

Engine Control Unit

## EDC17CP04 TC1796

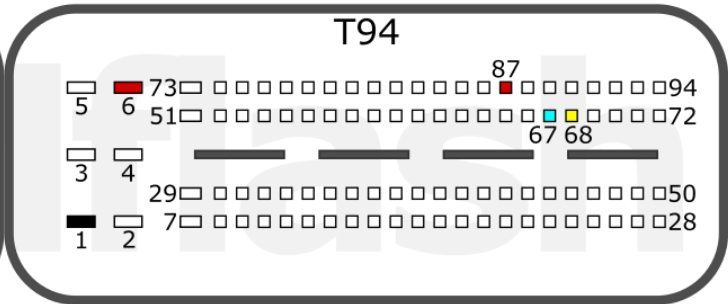
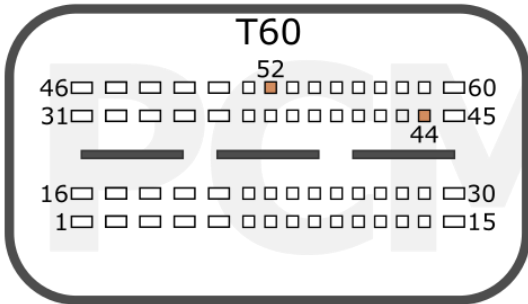

<b>+12V</b>	T94: 6, 87	<b>CAN-L</b>	T94: 67
<b>GND</b>	T94: 1	<b>CAN-H</b>	T94: 68
<b>GPT</b>	T60: 52, 44		

AUDI

pcmflash.ru

v.1

2021-09-09

# PCMflash

Engine Control Unit

EDC17CP05 TC1796/TC1797

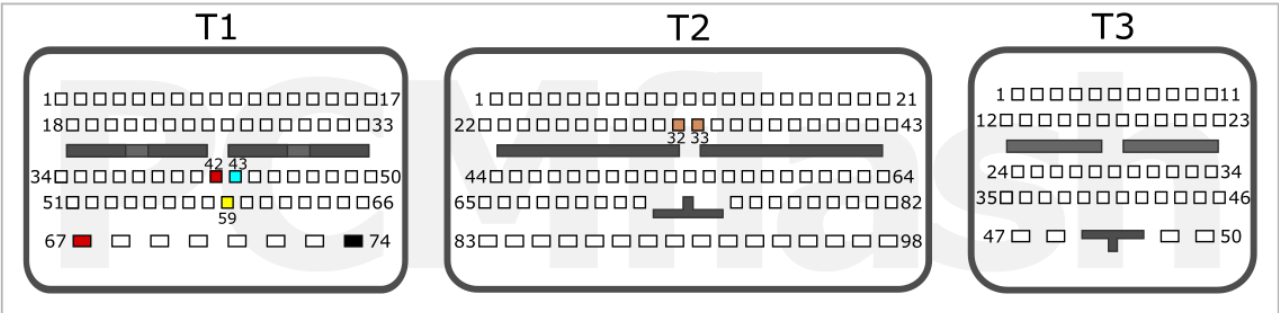

<b>+12V</b>	T1: 42, 67	<b>CAN-L</b>	T1: 43
<b>GND</b>	T1: 74	<b>CAN-H</b>	T1: 59
<b>GPT</b>	T2: 32, 33		

FORD

pcmflash.ru

v.2

2022-08-09



# PCMflash

Engine Control Unit

## EDC17CP06 TC1796

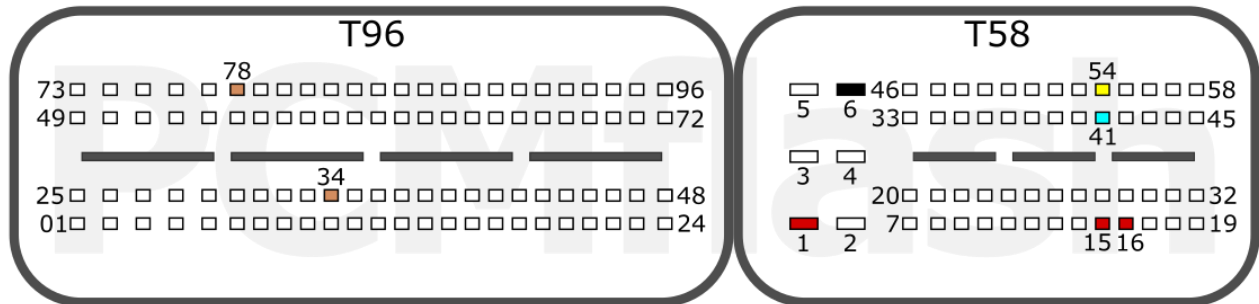

<b>+12V</b>	T58: 1, 15, 16	<b>CAN-L</b>	T58: 41
<b>GND</b>	T58: 6	<b>CAN-H</b>	T58: 54
<b>GPT</b>	T96: 34, 78		

HONDA

pcmflash.ru

v.1

2021-10-10

# PCMflash

Engine Control Unit

## EDC17CP07 TC1766

T1

T2

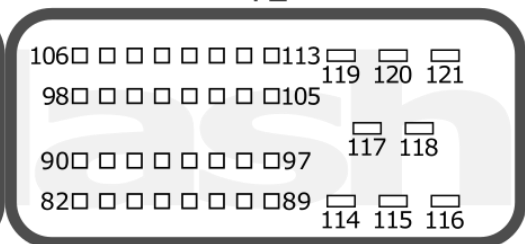
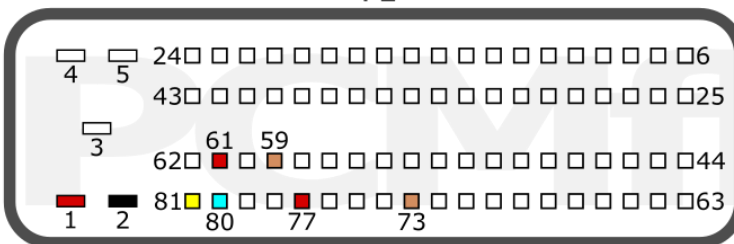

<b>+12V</b>	T1: 1, 61, 77	<b>CAN-L</b>	T1: 80
<b>GND</b>	T1: 2	<b>CAN-H</b>	T1: 81
<b>GPT</b>	T1: 59, 73		

TOYOTA

pcmflash.ru

v.1

2021-09-06

# PCMflash

Engine Control Unit

EDC17CP09 TC1796

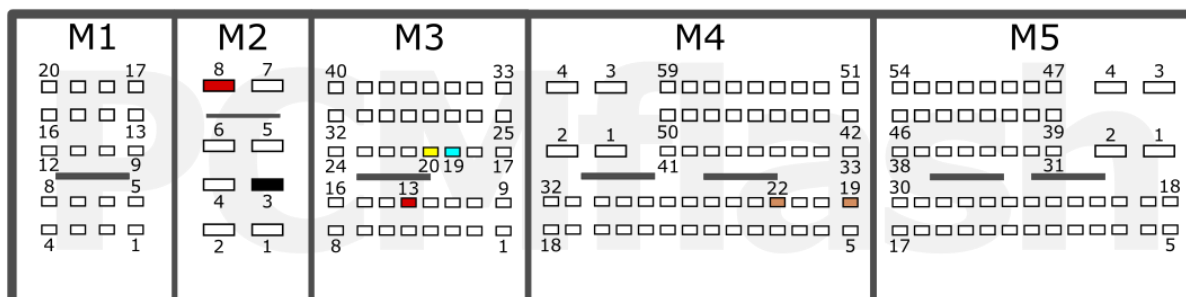

<b>+12V</b>	M2: 8, M3:13	<b>CAN-L</b>	M3: 19
<b>GND</b>	M2: 3	<b>CAN-H</b>	M3: 20
<b>GPT</b>	M4: 22, 19		

BMW

pcmflash.ru

v.1

2021-10-12

# PCMflash

Engine Control Unit

## EDC17CP10 TC1796

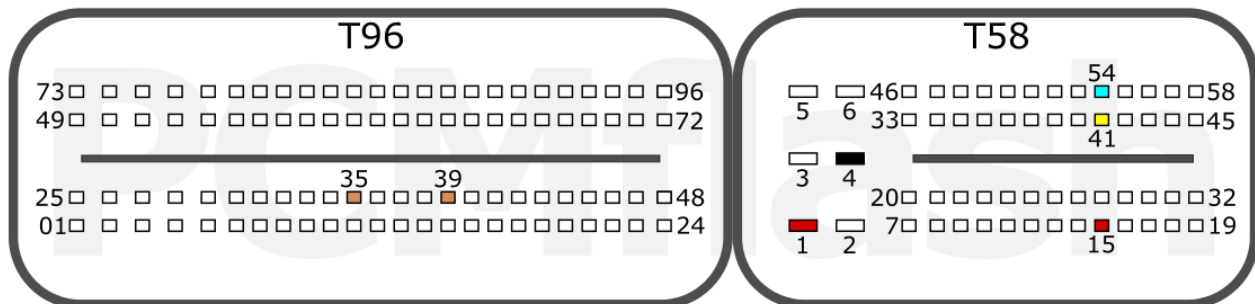

<b>+12V</b>	T58: 1, 15	<b>CAN-L</b>	T58: 54
<b>GND</b>	T58: 4	<b>CAN-H</b>	T58: 41
<b>GPT</b>	T96: 35, 39		

MB

pcmflash.ru

v.1

2021-08-27

# PCMflash

Engine Control Unit

EDC17CP11 TC1796

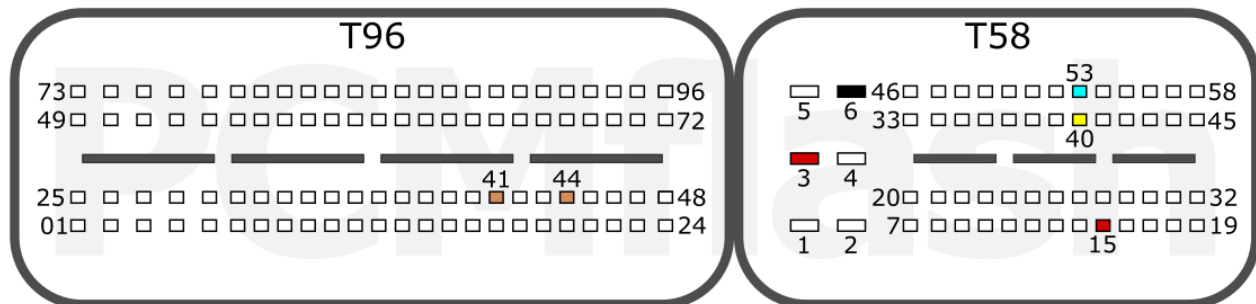

<b>+12V</b>	T58: 3, 15	<b>CAN-L</b>	T58: 53
<b>GND</b>	T58: 6	<b>CAN-H</b>	T58: 40
<b>GPT</b>	T96: 41, 44		

JLR

pcmflash.ru

v.1

2021-08-25

# PCMflash

Engine Control Unit

EDC17CP14 TC1796

## Connection version 1

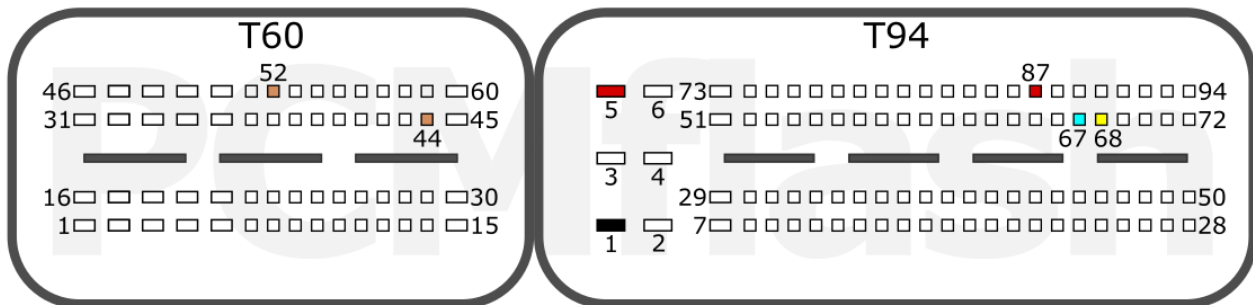

<b>+12V</b>	T94: 5, 87	<b>CAN-L</b>	T94: 67
<b>GND</b>	T94: 1	<b>CAN-H</b>	T94: 68
<b>GPT</b>	T60: 52, 44		

## Connection version 2

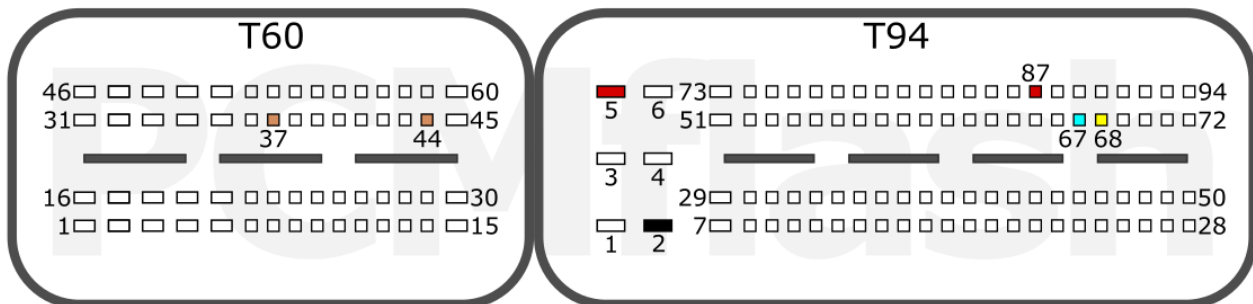

<b>+12V</b>	T94: 5, 87	<b>CAN-L</b>	T94: 67
<b>GND</b>	T94: 2	<b>CAN-H</b>	T94: 68
<b>GPT</b>	T60: 37, 44		

K/H

VAG

pcmflash.ru

v.1

2021-10-12

# PCMflash

Engine Control Unit

## EDC17CP15 TC1796

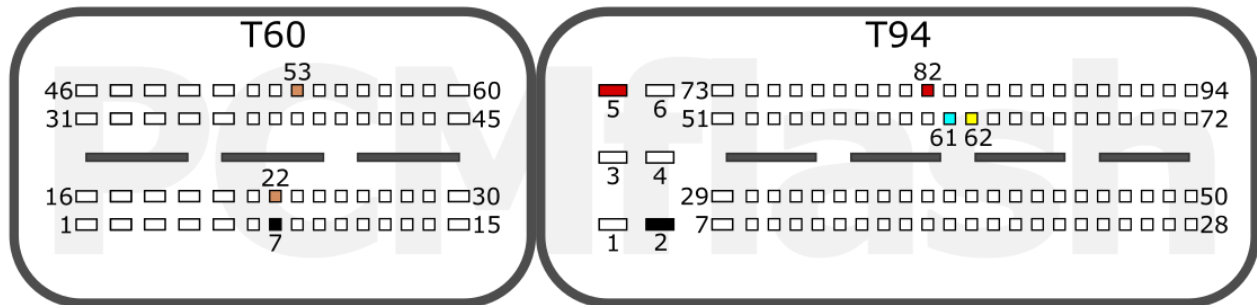

<b>+12V</b>	T94: 5, 82	<b>CAN-L</b>	T94: 61
<b>GND</b>	T60: 7, T94: 2	<b>CAN-H</b>	T94: 62
<b>GPT</b>	T60: 53, 22*		
* 10-50uF capacitor may be required			

MITSUBISHI

pcmflash.ru

v.1

2021-10-14

# PCMflash

Engine Control Unit

## EDC17CP16 TC1796

### Connection version 1

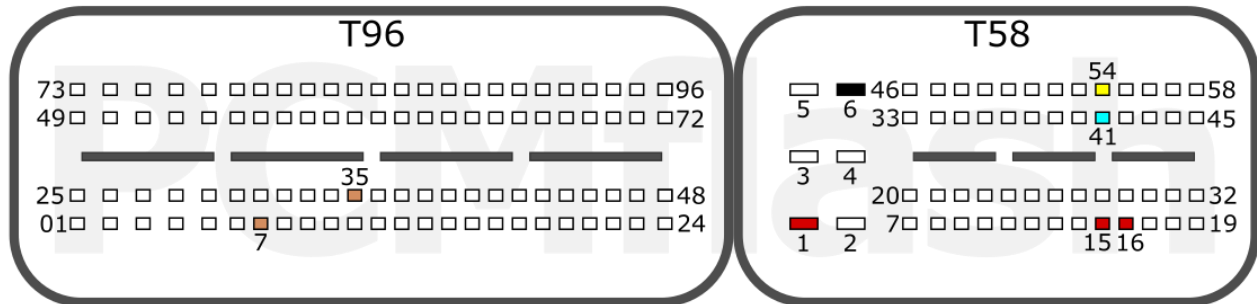

<b>+12V</b>	T58: 1, 15, 16	<b>CAN-L</b>	T58: 41
<b>GND</b>	T58: 6	<b>CAN-H</b>	T58: 54
<b>GPT</b>	T96: 7, 35		

### Connection version 2

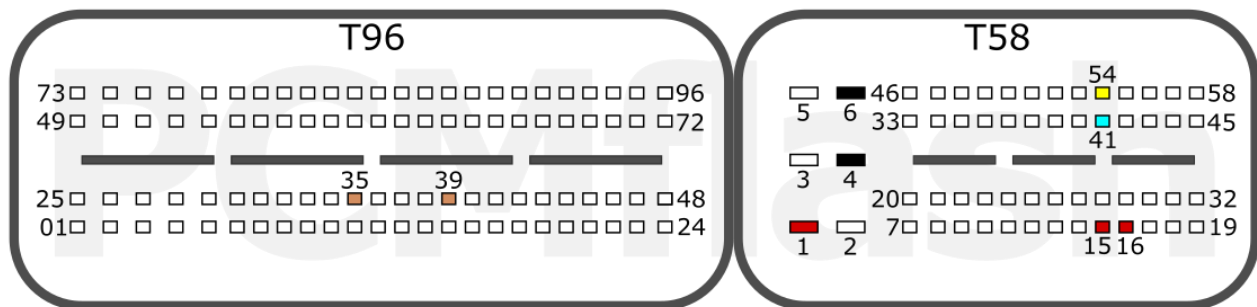

<b>+12V</b>	T58: 1, 15, 16	<b>CAN-L</b>	T58: 41
<b>GND</b>	T58: 4, 6	<b>CAN-H</b>	T58: 54
<b>GPT</b>	T96: 39, 35		

HONDA

pcmflash.ru

v.2

2021-02-28



# PCMflash

Engine Control Unit

## EDC17CP18 TC1796

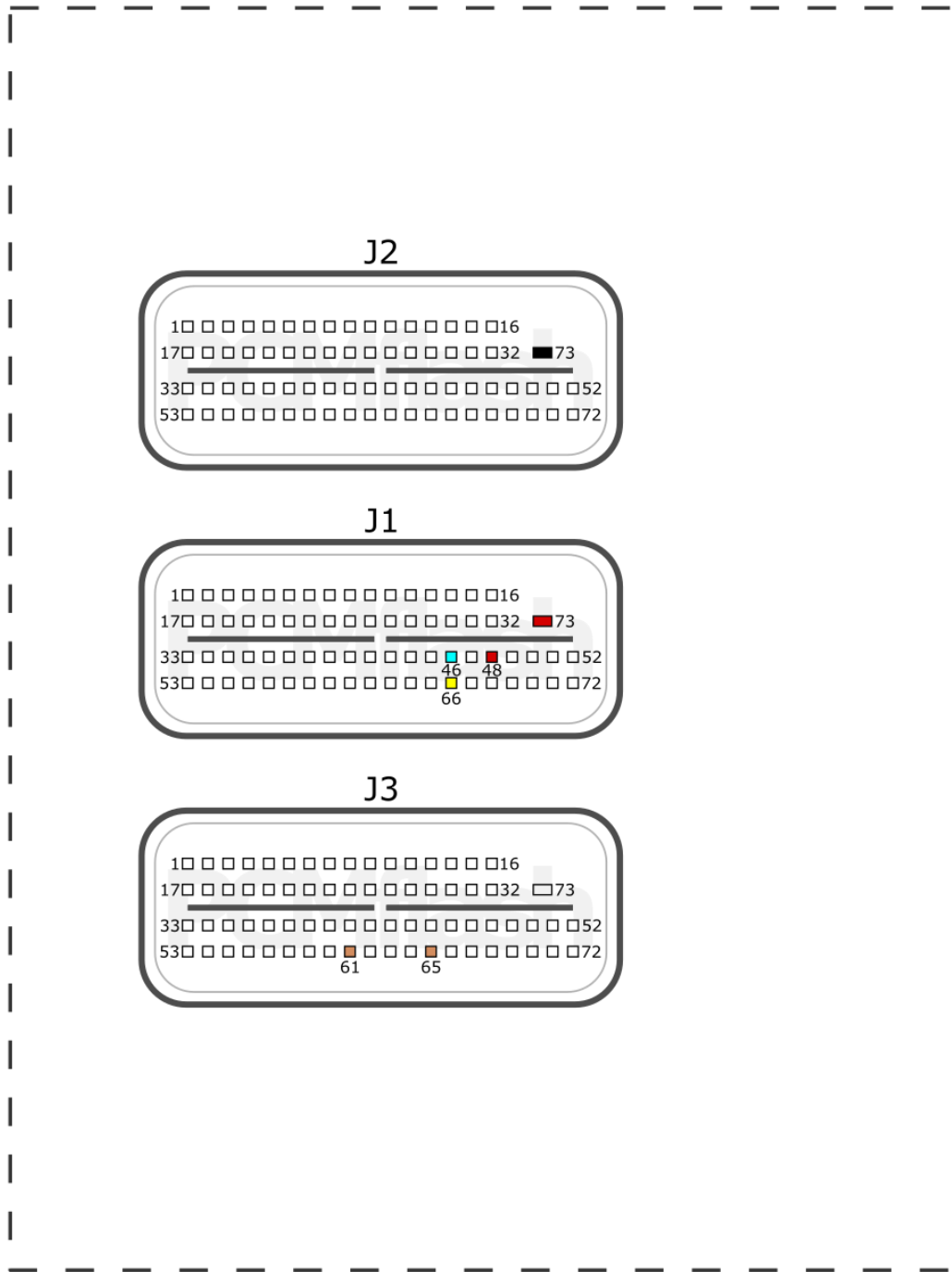

<b>+12V</b>	J1: 73, 48	<b>CAN-L</b>	J1: 46
<b>GND</b>	J2: 73	<b>CAN-H</b>	J1: 66
<b>GPT</b>	J3: 61, 65		

GM

pcmflash.ru

v.1

2021-11-26

# PCMflash

Engine Control Unit

EDC17CP19 TC1766

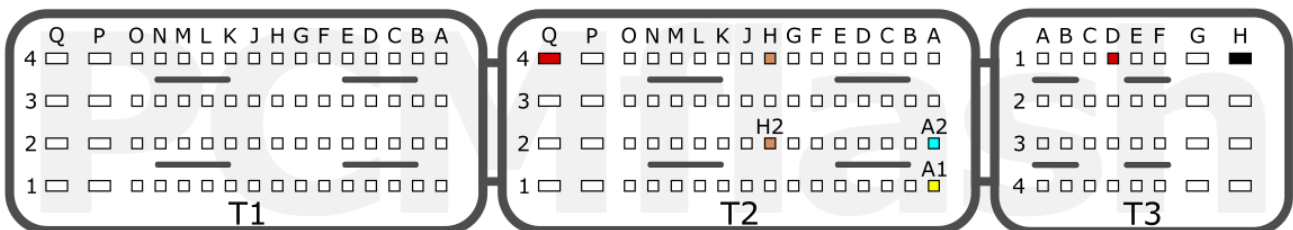

<b>+12V</b>	T2: Q4, T3:D1	<b>CAN-L</b>	T2: A2
<b>GND</b>	T3: H1	<b>CAN-H</b>	T2: A1
<b>GPT</b>	T2: H2, H4		

RENAULT

pcmflash.ru

v.2

2023-01-22

# PCMflash

Engine Control Unit

## EDC17CP20 TC1796

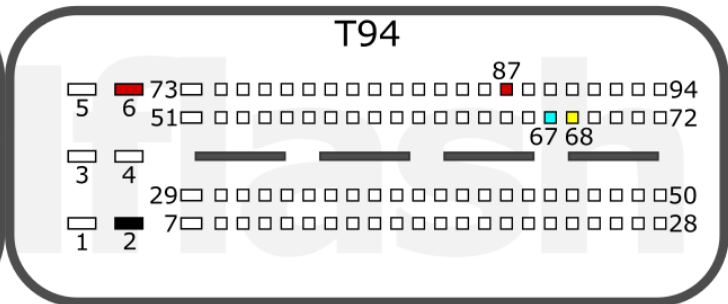
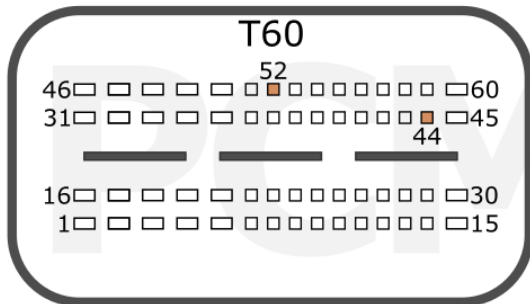

<b>+12V</b>	T94: 6, 87	<b>CAN-L</b>	T94: 67
<b>GND</b>	T94: 2	<b>CAN-H</b>	T94: 68
<b>GPT</b>	T60: 52, 44		

VAG

pcmflash.ru

v.1

2021-08-26

# PCMflash

Engine Control Unit

EDC17CP21 TC1792

T96

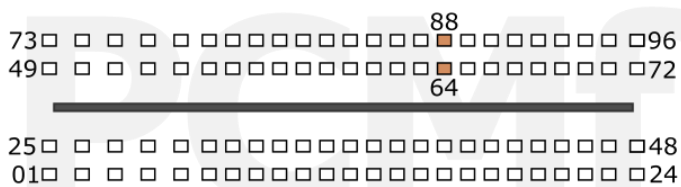

T58

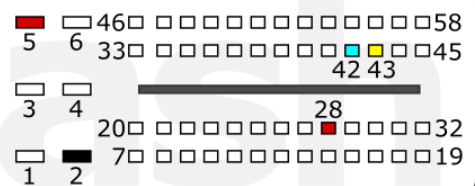

<b>+12V</b>	T58: 5, 28	<b>CAN-L</b>	T58: 42
<b>GND</b>	T58: 2	<b>CAN-H</b>	T58: 43
<b>GPT</b>	T96: 88, 64		

SAAB

pcmflash.ru

v.1

2021-10-31

# PCMflash

Engine Control Unit

## EDC17CP22 TC1796

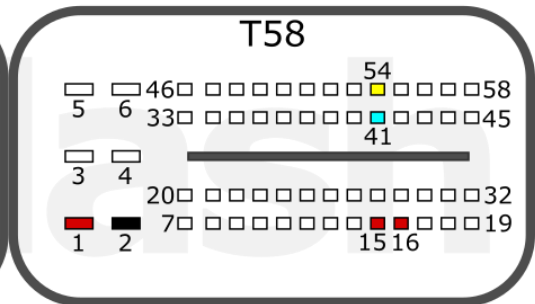
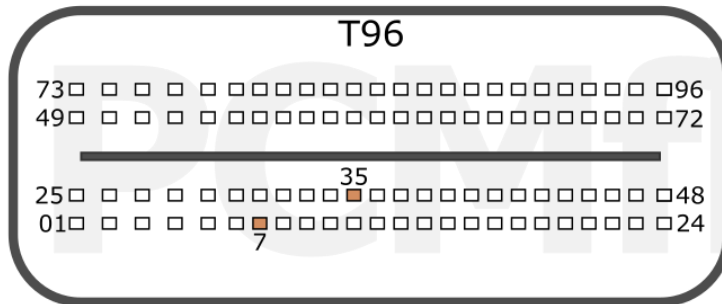

<b>+12V</b>	T58: 1, 15, 16	<b>CAN-L</b>	T58: 41
<b>GND</b>	T58: 2	<b>CAN-H</b>	T58: 54
<b>GPT</b>	T96: 35, 7		

VOLVO

pcmflash.ru

v.1

2021-09-09

# PCMflash

Engine Control Unit

## EDC17CP24 TC1796

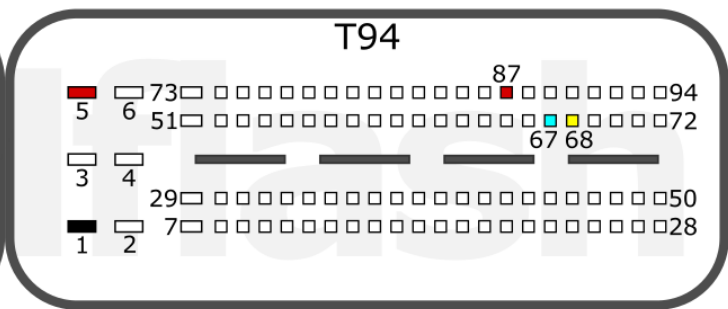
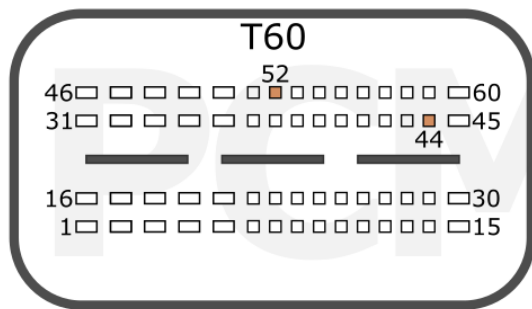

<b>+12V</b>	T94: 5, 87	<b>CAN-L</b>	T94: 67
<b>GND</b>	T94: 1	<b>CAN-H</b>	T94: 68
<b>GPT</b>	T60: 52, 44		

VAG

pcmflash.ru

v.1

2021-09-26

## PCMflash

Engine Control Unit

EDC17CP27 TC1796

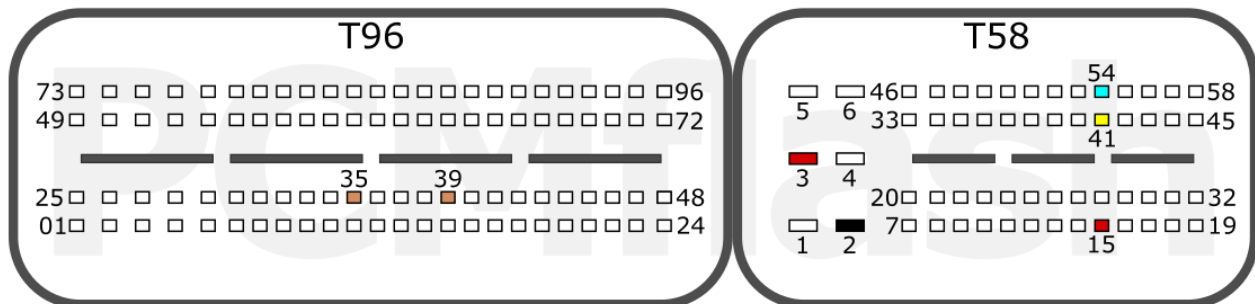

<b>+12V</b>	T58: 3, 15	<b>CAN-L</b>	T58: 54
<b>GND</b>	T58: 2	<b>CAN-H</b>	T58: 41
<b>GPT</b>	T96: 35, 39		

JEEP

pcmflash.ru

v.1

2021-10-13

# PCMflash

Engine Control Unit

EDC17CP37 TC1766

## Connection version 1

T1

T2

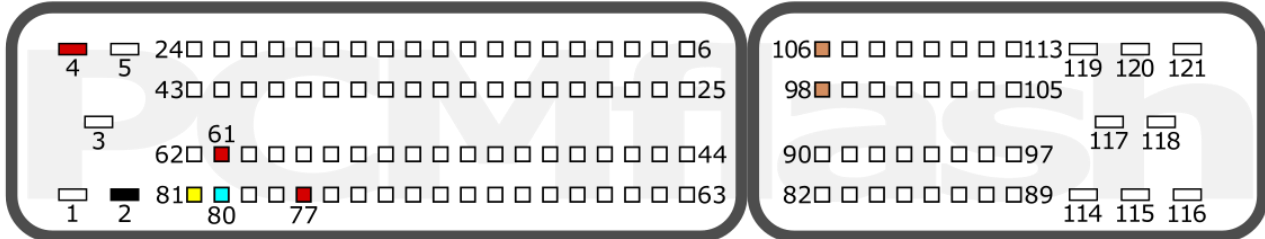

<b>+12V</b>	T1: 4, 61, 77	<b>CAN-L</b>	T1: 80
<b>GND</b>	T1: 2	<b>CAN-H</b>	T1: 81
<b>GPT</b>	T2: 98, 106		

## Connection version 2

T1

T2



<b>+12V</b>	T1: 4, 61, 77	<b>CAN-L</b>	T1: 80
<b>GND</b>	T1: 2	<b>CAN-H</b>	T1: 81
<b>GPT</b>	T1: 59, 73		

TOYOTA

pcmflash.ru

v.2

2023-02-18



# PCMflash

Engine Control Unit

EDC17CP42 TC1797

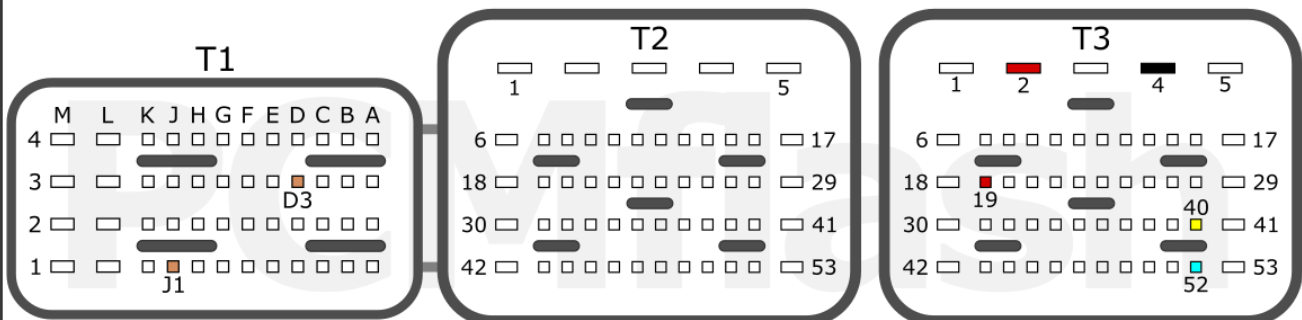

<b>+12V</b>	T3: 2, 19	<b>CAN-L</b>	T3: 52
<b>GND</b>	T3: 4	<b>CAN-H</b>	T3: 40
<b>GPT</b>	T1: D3, J1		

JLR

pcmflash.ru

v.1

2021-09-09

# PCMflash

Engine Control Unit

EDC17CP44 TC1797

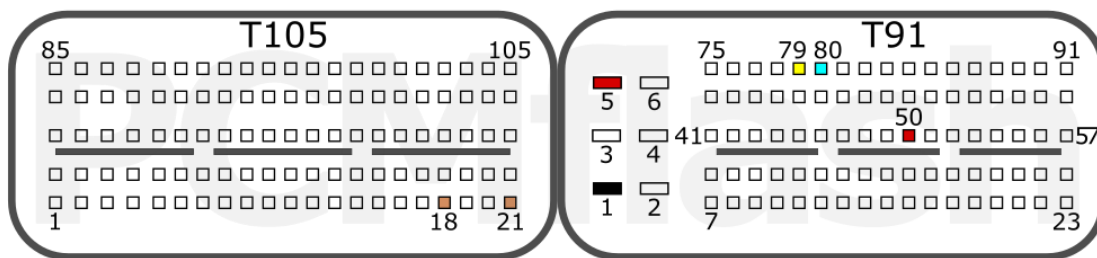

<b>+12V</b>	T91: 5, 50	<b>CAN-L</b>	T91: 80
<b>GND</b>	T91: 1	<b>CAN-H</b>	T91: 79
<b>GPT</b>	T105: 18, 21		

VAG

pcmflash.ru

v.1

2021-08-25

# PCMflash

Engine Control Unit

## EDC17CP45 TC1797

### DME8 E71

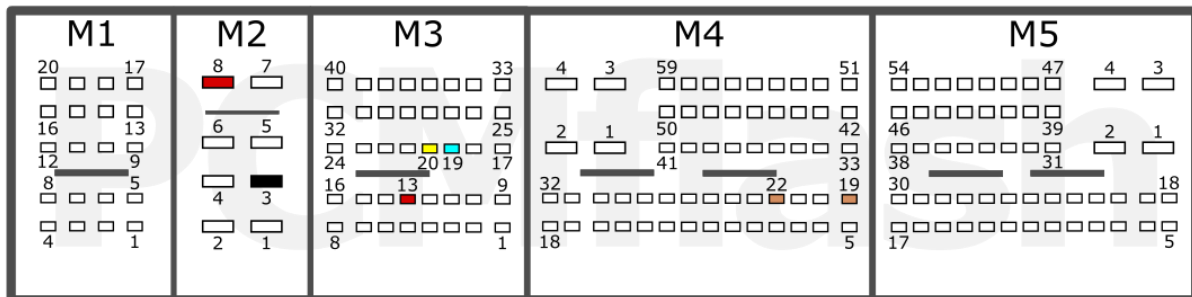

<b>+12V</b>	M2: 8, M3: 13	<b>CAN-L</b>	M3: 19
<b>GND</b>	M2: 3	<b>CAN-H</b>	M3: 20
<b>GPT</b>	M4: 22, 19		

### F10

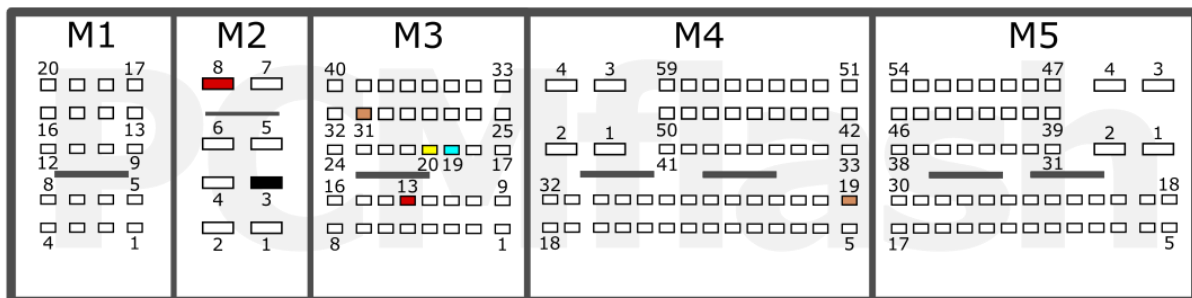

<b>+12V</b>	M2: 8, M3: 13	<b>CAN-L</b>	M3: 19
<b>GND</b>	M2: 3	<b>CAN-H</b>	M3: 20
<b>GPT</b>	M3: 31, M4: 19		

### BMW

pcmflash.ru

v.1

2021-08-26

# PCMflash

Engine Control Unit

EDC17CP46 TC1797

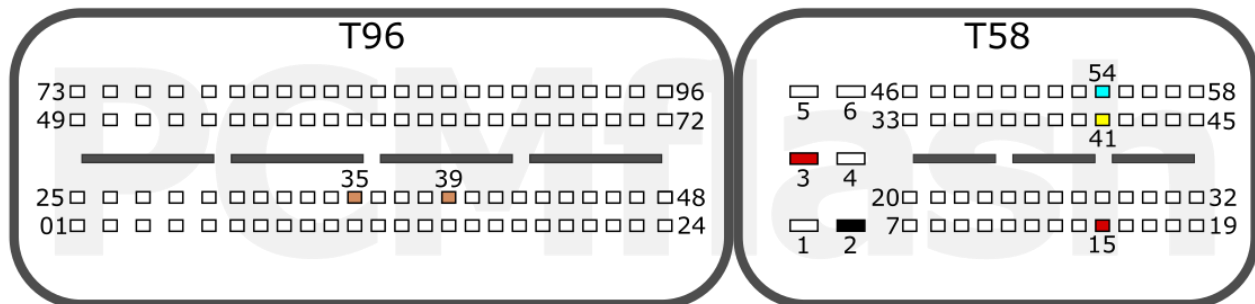

<b>+12V</b>	T58: 3, 15	<b>CAN-L</b>	T58: 54
<b>GND</b>	T58: 2	<b>CAN-H</b>	T58: 41
<b>GPT</b>	T96: 35, 39		

MB

pcmflash.ru

v.1

2021-09-28

# PCMflash

Engine Control Unit

EDC17CP47 TC1797

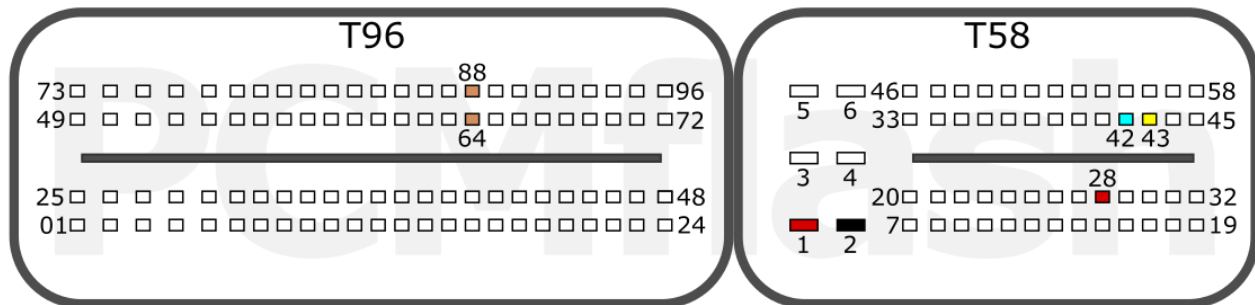

<b>+12V</b>	T58: 1, 28	<b>CAN-L</b>	T58: 42
<b>GND</b>	T58: 2	<b>CAN-H</b>	T58: 43
<b>GPT</b>	T96: 88, 64		

OPEL

pcmflash.ru

v.1

2021-09-11

# PCMflash

Engine Control Unit  
EDC17CP48 TC1797

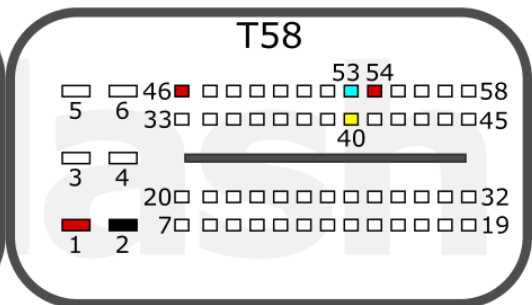

<b>+12V</b>	T58: 1, 46, 54	<b>CAN-L</b>	T58: 53
<b>GND</b>	T58: 2	<b>CAN-H</b>	T58: 40
<b>GPT</b>	T96: 43, 40		

VOLVO

pcmflash.ru

v.1

2021-10-09

# PCMflash

Engine Control Unit

## EDC17CP49 TC1797



<b>+12V</b>	T58: 1, 18	<b>CAN-L</b>	T58: 55
<b>GND</b>	T58: 2	<b>CAN-H</b>	T58: 56
<b>GPT</b>	T96: 92, 89		

BMW

pcmflash.ru

v.1

2021-10-03





# PCMflash

Engine Control Unit

## EDC17CP52 TC1797

### Connection version 1

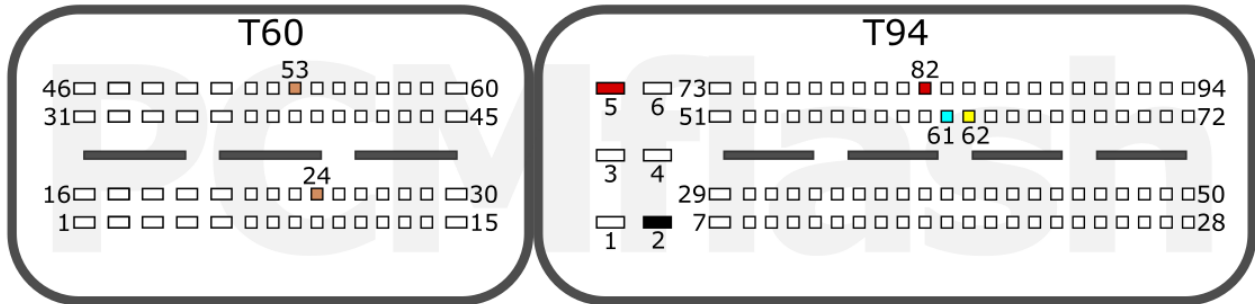

<b>+12V</b>	T94: 5, 82	<b>CAN-L</b>	T94: 61
<b>GND</b>	T94: 2	<b>CAN-H</b>	T94: 62
<b>GPT</b>	T60: 24, 53		

### Connection version 2

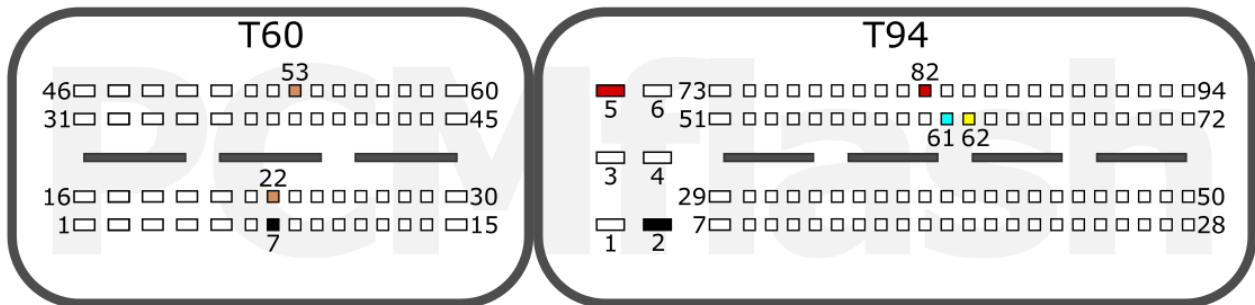

<b>+12V</b>	T94: 5, 82	<b>CAN-L</b>	T94: 61
<b>GND</b>	T60: 7, T94: 2	<b>CAN-H</b>	T94: 62
<b>GPT</b>	T60: 53, 22*		

\*10-47 uF 50v capacitor required on 22 GPT line /  
Подключить сигнал 22 GPT к ЭБУ через конденсатор 10-47 мкФ

FIAT

IVECO

MITSUBISHI

pcmflash.ru

v.3

2023-03-27

# PCMflash

Engine Control Unit

## EDC17CP54 TC1793

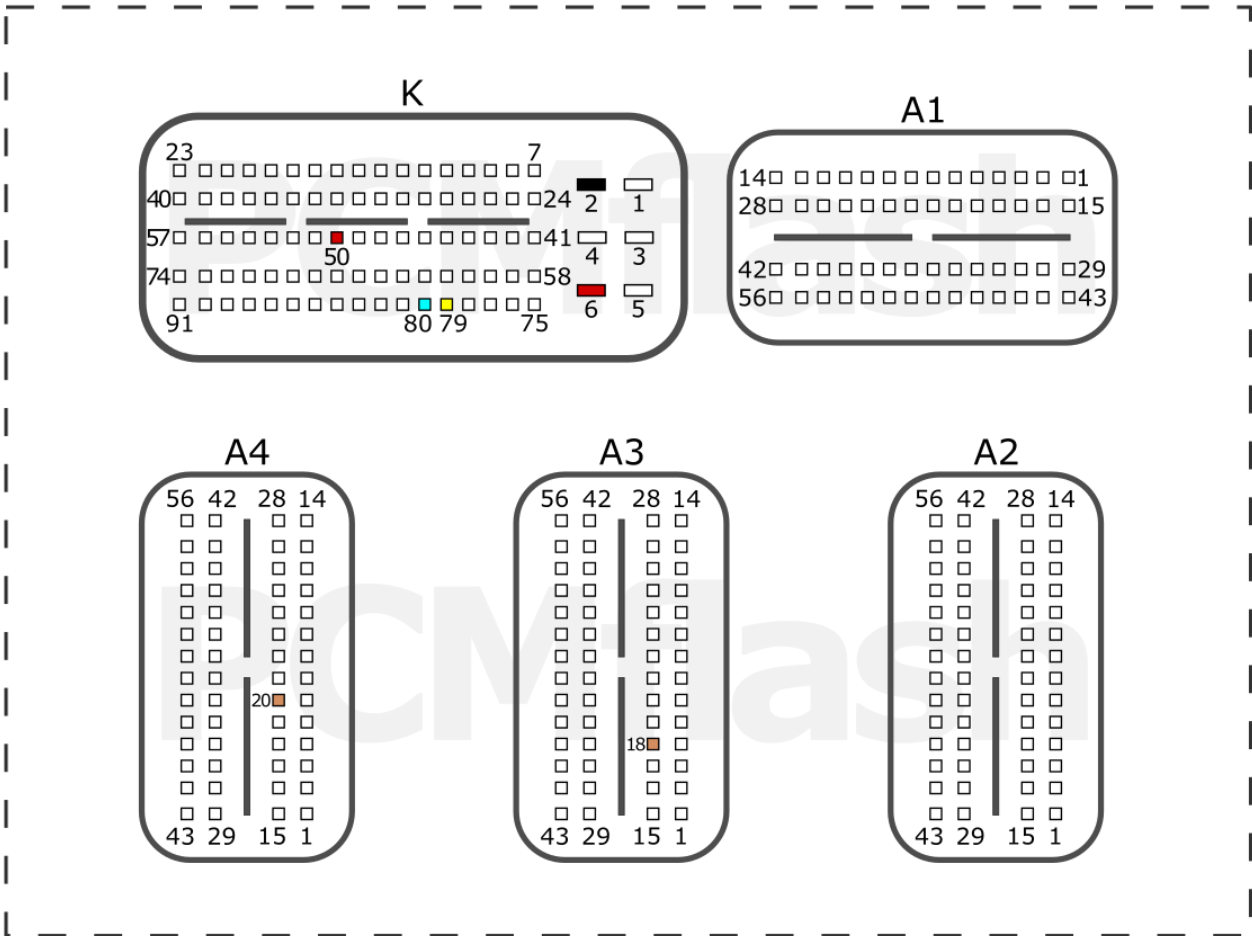

<b>+12V</b>	K: 6, 50	<b>CAN-L</b>	K: 80
<b>GND</b>	K: 2	<b>CAN-H</b>	K: 79
<b>GPT</b>	A3: 18, A4: 20		

AMAROK

pcmflash.ru

v.1

2022-12-21

# PCMflash

Engine Control Unit

## EDC17CP54 TC1793

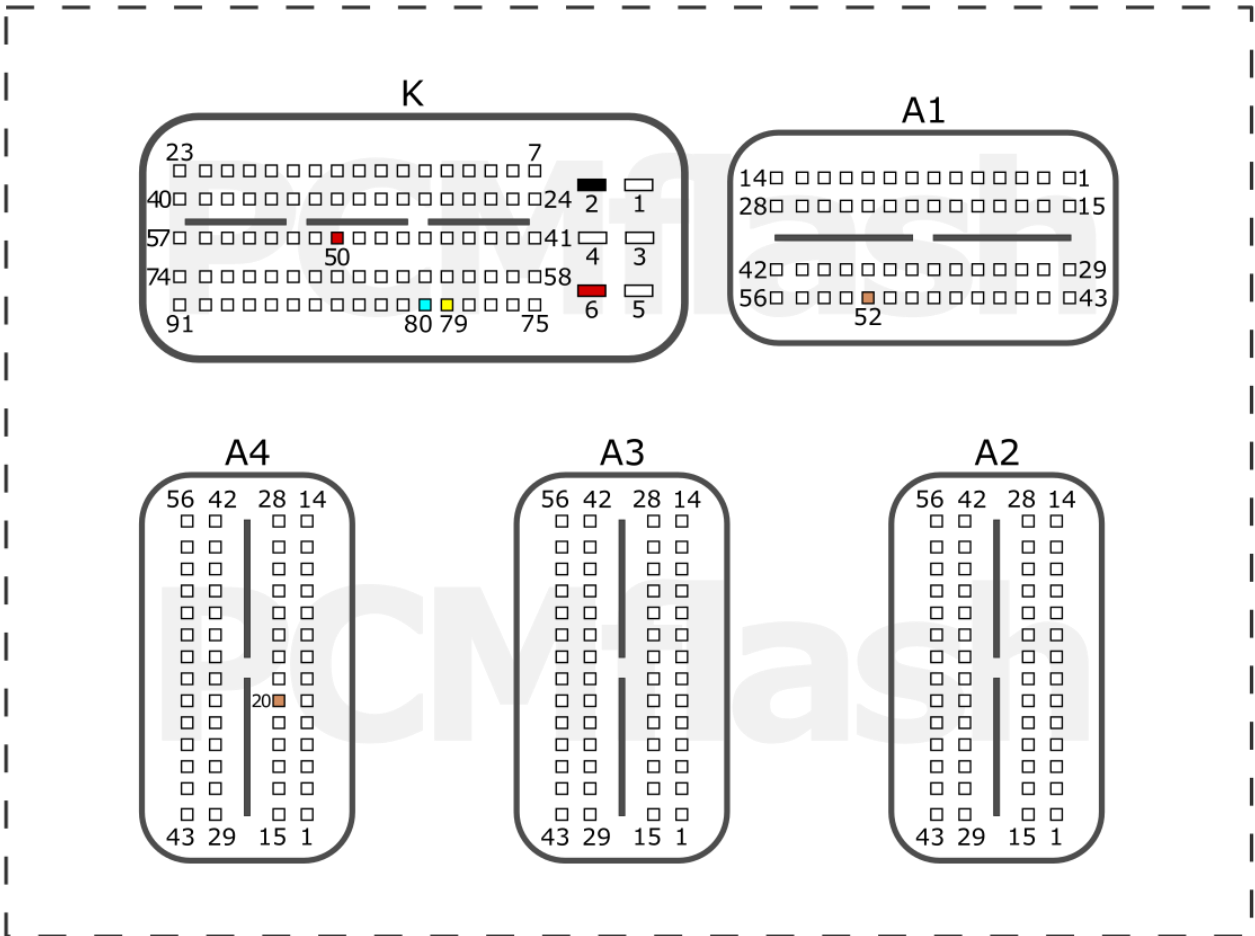

<b>+12V</b>	K: 6, 50	<b>CAN-L</b>	K: 80
<b>GND</b>	K: 2	<b>CAN-H</b>	K: 79
<b>GPT</b>	A4: 20, A1: 52		

AUDI

pcmflash.ru

v.1

2021-10-09

# PCMflash

Engine Control Unit

EDC17CP55 TC1793

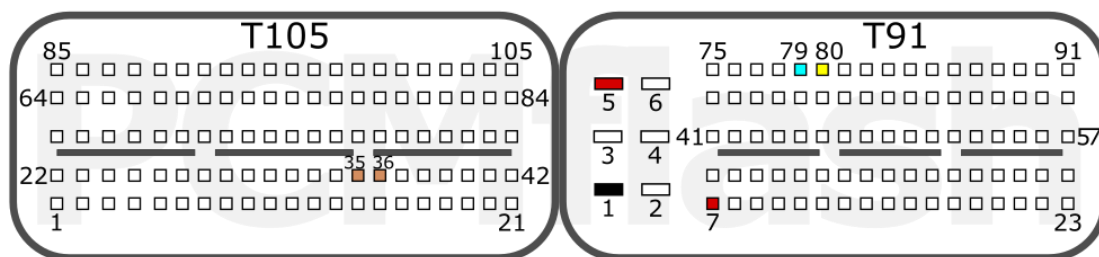

<b>+12V</b>	T91: 5, 7	<b>CAN-L</b>	T91: 79
<b>GND</b>	T91: 1	<b>CAN-H</b>	T91: 80
<b>GPT</b>	T105: 35, 36		

LAND ROVER

pcmflash.ru

v.2

2022-06-08

# PCMflash

Engine Control Unit

## EDC17CP57 TC1793

### Connection version 1



<b>+12V</b>	T58: 3, 15	<b>CAN-L</b>	T58: 54
<b>GND</b>	T58: 2	<b>CAN-H</b>	T58: 41
<b>GPT</b>	T96: 35, 39		

### Connection version 2

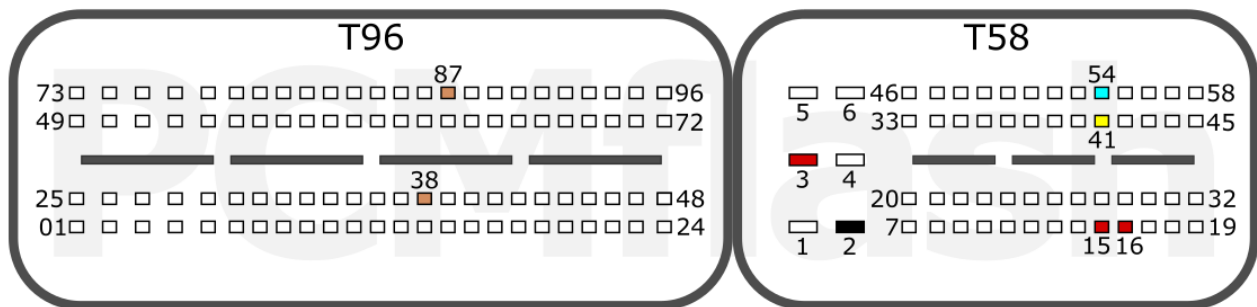

<b>+12V</b>	T58: 3, 15, 16	<b>CAN-L</b>	T58: 54
<b>GND</b>	T58: 2	<b>CAN-H</b>	T58: 41
<b>GPT</b>	T96: 87, 38		

MB

pcmflash.ru

v.1

2021-10-11

# PCMflash

Engine Control Unit

EDC17CP58 TC1767

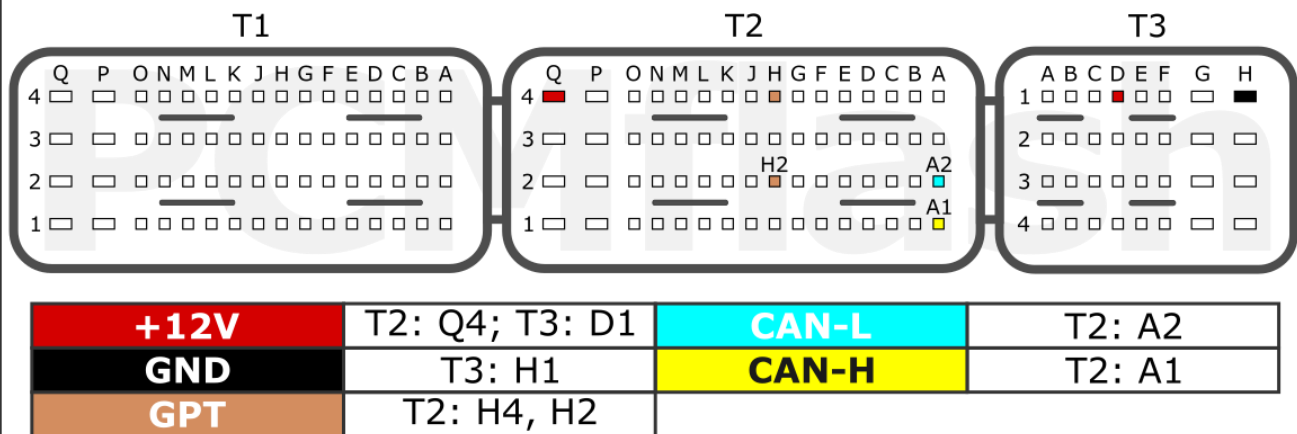

RENAULT

pcmflash.ru

v.1

2023-09-10

# PCMflash

Engine Control Unit

EDC17CP60 TC1793

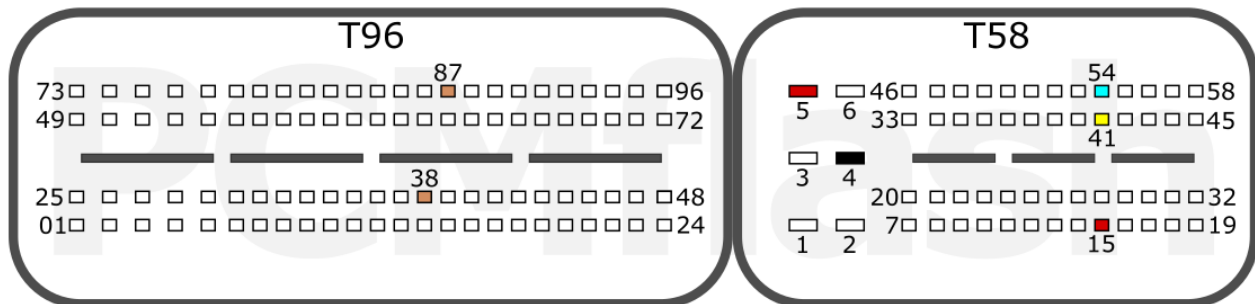

<b>+12V</b>	T58: 5, 15	<b>CAN-L</b>	T58: 54
<b>GND</b>	T58: 4	<b>CAN-H</b>	T58: 41
<b>GPT</b>	T96: 87, 38		

MB

pcmflash.ru

v.1

2023-05-21

# PCMflash

Engine Control Unit

EDC17CP62 TC1793

T105

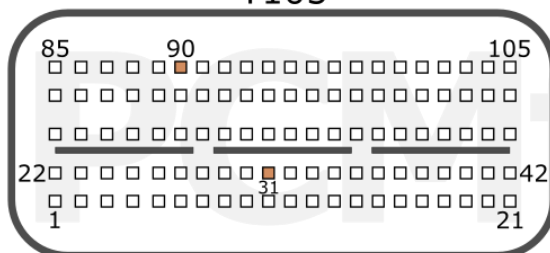

T91

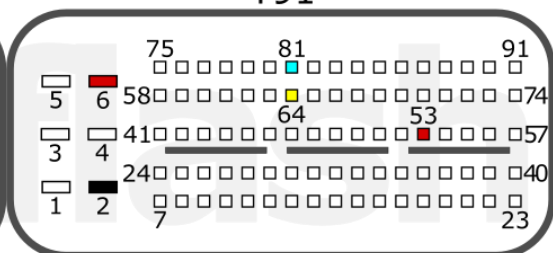

<b>+12V</b>	T91: 6, 53	<b>CAN-L</b>	T91: 81
<b>GND</b>	T91: 2	<b>CAN-H</b>	T91: 64
<b>GPT</b>	T105: 31, 90		

K/H

pcmflash.ru

v.1

2022-02-03



# PCMflash

Engine Control Unit

## EDC17CP65 TC1793

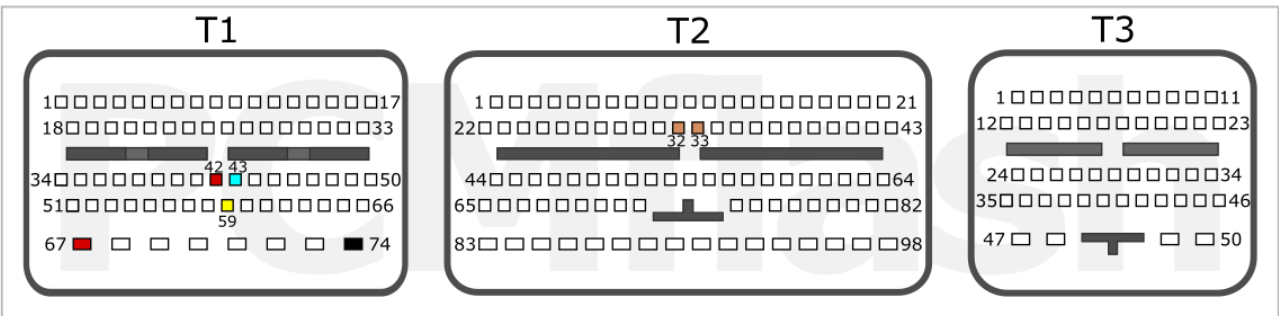

<b>+12V</b>	T1: 42, 67	<b>CAN-L</b>	T1: 43
<b>GND</b>	T1: 74	<b>CAN-H</b>	T1: 59
<b>GPT</b>	T2: 32, 33		

FORD

pcmflash.ru

v.2

2022-08-09

# PCMflash

Engine Control Unit

## EDC17CP68 TC1797

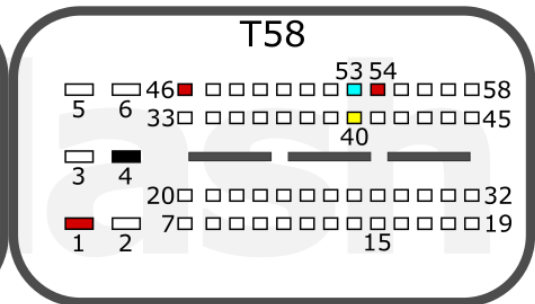
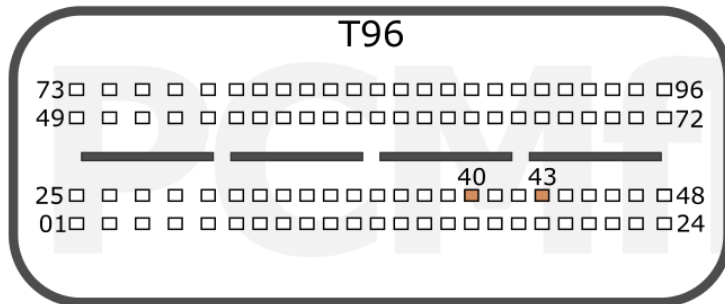

<b>+12V</b>	T58: 1, 46, 54	<b>CAN-L</b>	T58: 53
<b>GND</b>	T58: 4	<b>CAN-H</b>	T58: 40
<b>GPT</b>	T96: 43, 40		

VOLVO

pcmflash.ru

v.1

2021-10-03

# PCMflash

Engine Control Unit

EDC17CP74 TC1793

T105

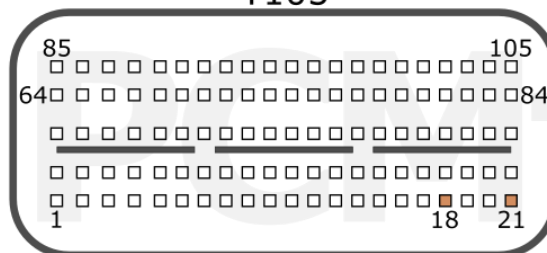

T91

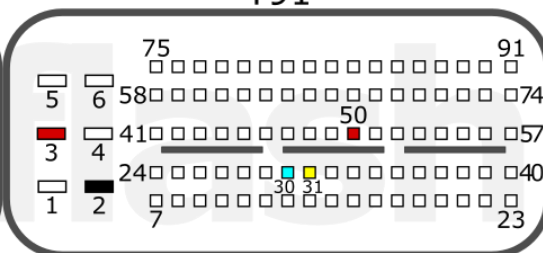

<b>+12V</b>	T91: 3, 50	<b>CAN-L</b>	T91: 30
<b>GND</b>	T91: 2	<b>CAN-H</b>	T91: 31
<b>GPT</b>	T105: 21, 18		

VAG

pcmflash.ru

v.1

2022-01-24

# PCMflash

Engine Control Unit

## EDC17CV41 TC1797

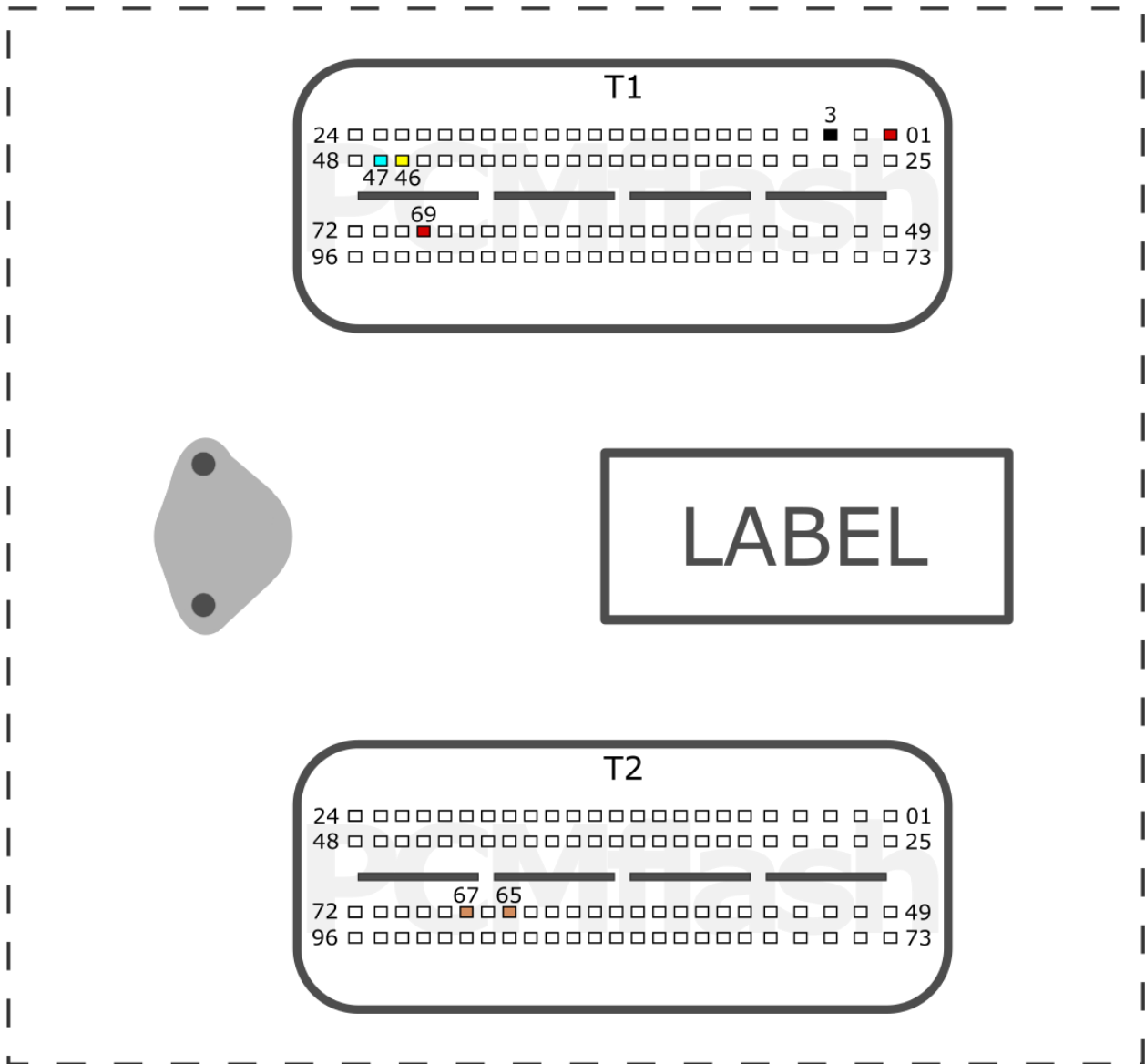

<b>+12V</b>	T1: 1, 69	<b>CAN-L</b>	T1: 47
<b>GND</b>	T1: 3	<b>CAN-H</b>	T1: 46
<b>GPT</b>	T2: 67, 65		

See next page/смотри следующую страницу

COMMERCIAL

# PCMflash

Engine Control Unit

## EDC17CV41 TC1797

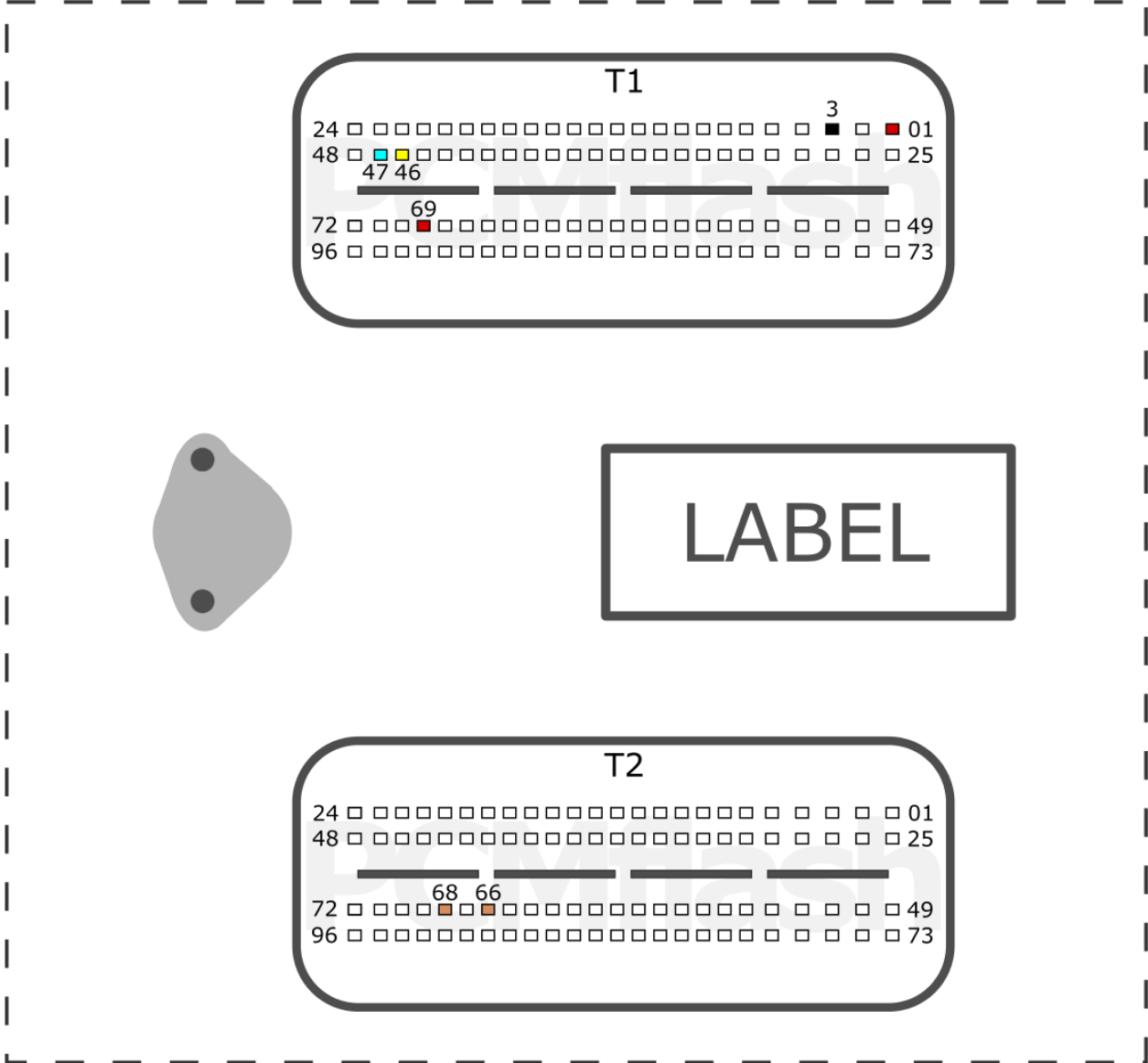

<b>+12V</b>	T1: 1, 69	<b>CAN-L</b>	T1: 47
<b>GND</b>	T1: 3	<b>CAN-H</b>	T1: 46
<b>GPT</b>	T2: 66, 68		

COMMERCIAL

pcmflash.ru

v.1

2023-04-22

# PCMflash

Engine Control Unit

EDC17CV42 TC1797

T96

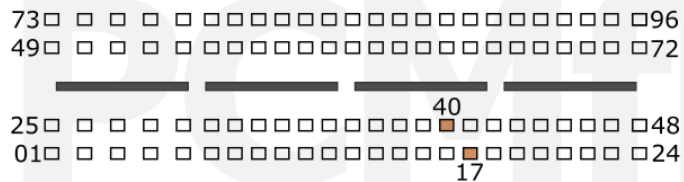

T16

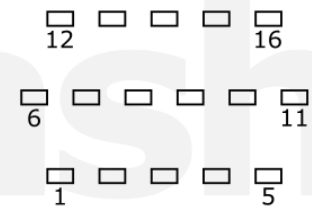

LABEL

T58

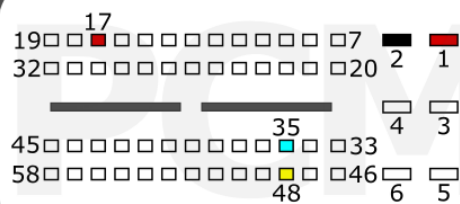

<b>+12V</b>	T58: 17, 1	<b>CAN-L</b>	T58: 35
<b>GND</b>	T58: 2	<b>CAN-H</b>	T58: 48
<b>GPT</b>	T96: 17, 40		

MAN

pcmflash.ru

v.1

2021-08-27

# PCMflash

Engine Control Unit

EDC17CV43/CV44 TC1767

## Connection version 1

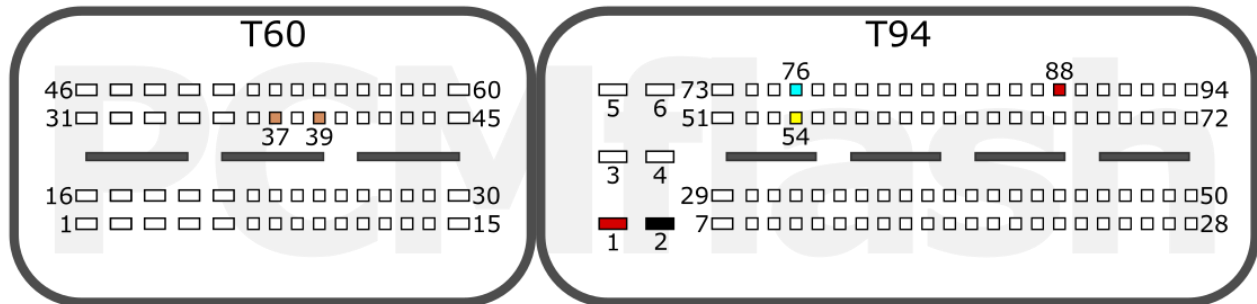

<b>+12V</b>	T94: 1, 88	<b>CAN-L</b>	T94: 76
<b>GND</b>	T94: 2	<b>CAN-H</b>	T94: 54
<b>GPT</b>	T60: 37, 39		

## Connection version 2

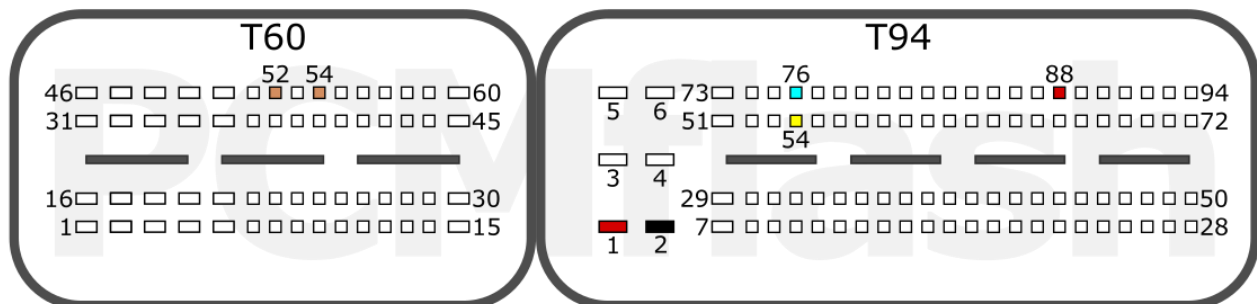

<b>+12V</b>	T94: 1, 88	<b>CAN-L</b>	T94: 76
<b>GND</b>	T94: 2	<b>CAN-H</b>	T94: 54
<b>GPT</b>	T60: 52, 54		

FAW

pcmflash.ru

v.3

2023-11-25

# PCMflash

Engine Control Unit

## EDC17CV52 TC1797

T105

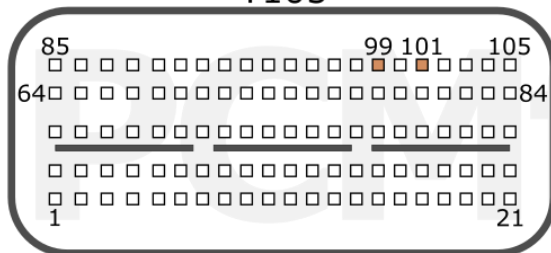

T91

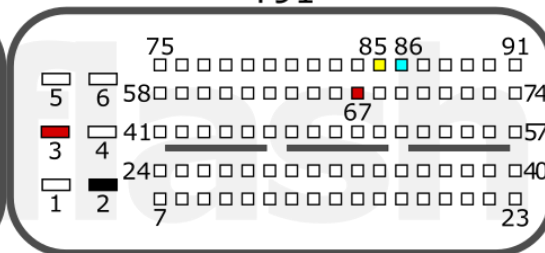

<b>+12V</b>	T91: 3, 67	<b>CAN-L</b>	T91: 86
<b>GND</b>	T91: 2	<b>CAN-H</b>	T91: 85
<b>GPT</b>	T105: 99, 101		

DEUTZ

pcmflash.ru

v.1

2021-10-12



# PCMflash

Engine Control Unit

EDC17CV53/CV54/CV56 TC1767

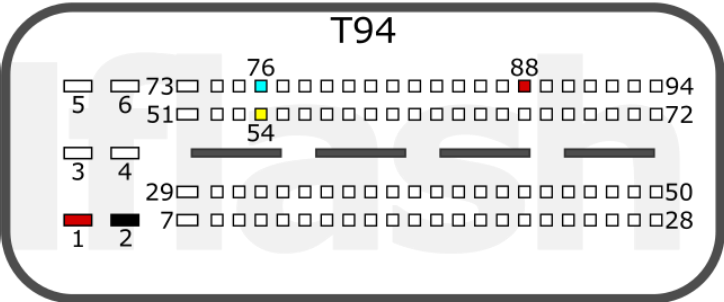
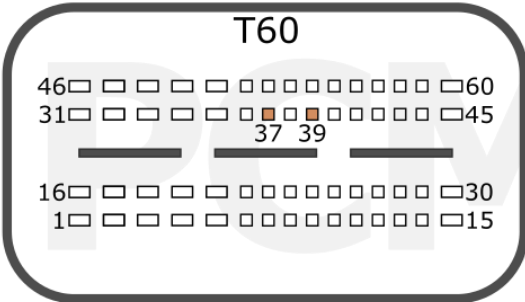

<b>+12V</b>	T94: 1, 88	<b>CAN-L</b>	T94: 76
<b>GND</b>	T94: 2	<b>CAN-H</b>	T94: 54
<b>GPT</b>	T60: 37, 39		

DEUTZ

FOTON

PAZ

pcmflash.ru

v.2

2022-05-23

# PCMflash

Engine Control Unit

## EDC17U01 TC1766

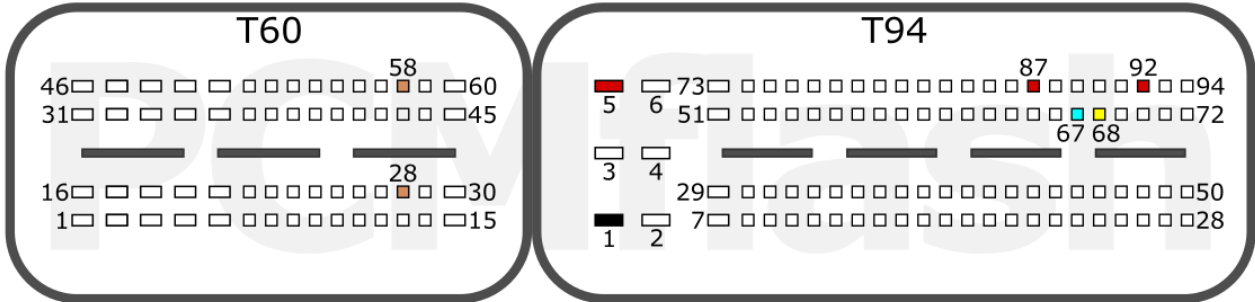

<b>+12V</b>	T94: 5, 87, 92	<b>CAN-L</b>	T94: 67
<b>GND</b>	T94: 1	<b>CAN-H</b>	T94: 68
<b>GPT</b>	T60: 28, 58		

VAG

pcmflash.ru

v.1

2021-10-03

# PCMflash

Engine Control Unit

# EDC17U05 TC1766

T60

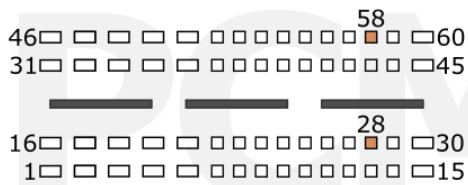

T94

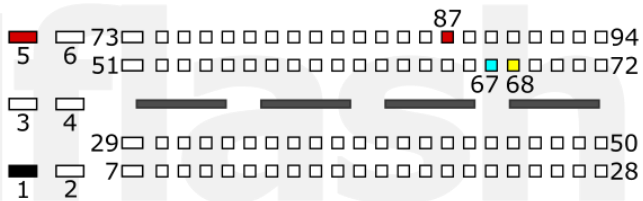

<b>+12V</b>	T94: 5, 87	<b>CAN-L</b>	T94: 67
<b>GND</b>	T94: 1	<b>CAN-H</b>	T94: 68
<b>GPT</b>	T60: 28, 58		

VAG

pcmflash.ru

v.1

2022-04-14

# PCMflash

AdBlue Control Unit

DCU17CV51 TC1724

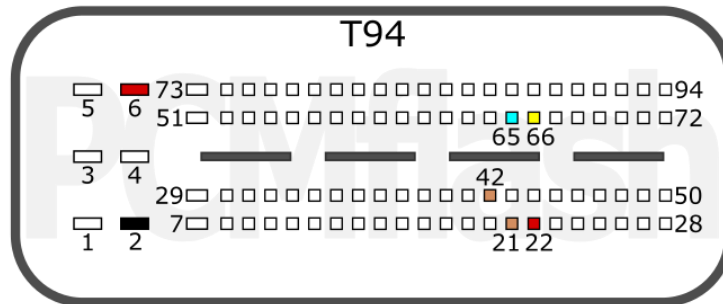

<b>+12V</b>	6, 22	<b>CAN-L</b>	65
<b>GND</b>	2	<b>CAN-H</b>	66
<b>GPT</b>	21, 42		

ALL

pcmflash.ru

v.1

2024-04-18

# PCMflash

AdBlue Control Unit

## DCU17HD01 TC1766

T86

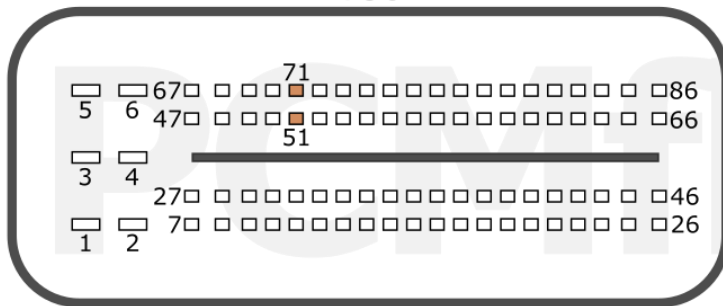

T53

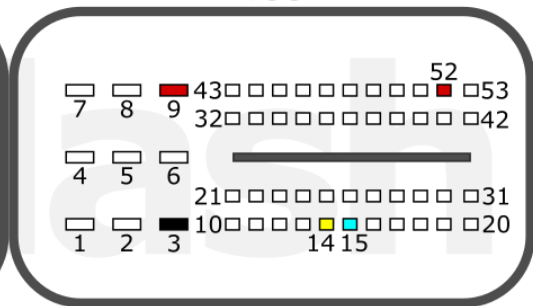

<b>+12V</b>	T53: 9, 52	<b>CAN-L</b>	T53: 15
<b>GND</b>	T53: 3	<b>CAN-H</b>	T53: 14
<b>GPT</b>	T86: 71, 51		

HINO

pcmflash.ru

v.2

2024-04-18

# PCMflash

AdBlue Control Unit

## DCU17PC01 TC1766

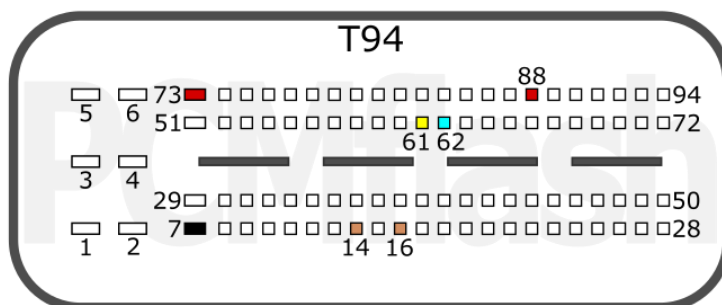

<b>+12V</b>	73, 88	<b>CAN-L</b>	62
<b>GND</b>	7	<b>CAN-H</b>	61
<b>GPT</b>	14, 16		

FORD

MB

pcmflash.ru

v.2

2024-04-18

# PCMflash

AdBlue Control Unit

## DCU17PC42/PC43 TC1724

### Connection version 1

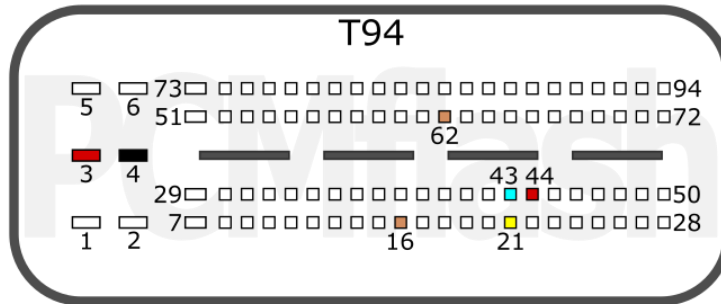

<b>+12V</b>	3, 44	<b>CAN-L</b>	43
<b>GND</b>	4	<b>CAN-H</b>	21
<b>GPT</b>	16, 62		

### Connection version 2

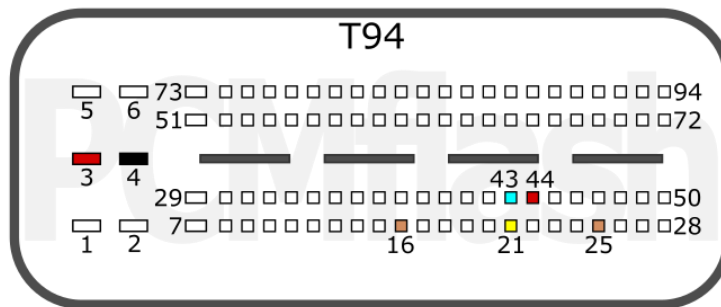

<b>+12V</b>	3, 44	<b>CAN-L</b>	43
<b>GND</b>	4	<b>CAN-H</b>	21
<b>GPT</b>	16, 25		

### Connection version 3

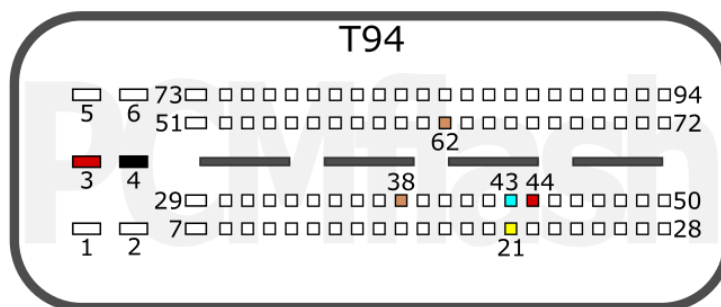

<b>+12V</b>	3, 44	<b>CAN-L</b>	43
<b>GND</b>	4	<b>CAN-H</b>	21
<b>GPT</b>	38, 62		