

# PCMflash module 71

Bosch MEDC17 Bootloader

## Contents/Оглавление

Contents/Оглавление.....	2
MED17.0 TC1767 .....	8
MEDG17.0 TC1797 .....	9
MED17.0.1 TC1767.....	10
ME17.0.3 TC1724 .....	11
MED17.1 TC1796.....	12
MED17.1.1 TC1797.....	13
MED17.1.6 TC1797.....	14
MED17.1.10 TC1793.....	15
MED17.1.11 TC1797.....	16
MED17.1.21 TC1793.....	17
MED17.1.27 TC1793.....	18
MED17.1.61 TC1793.....	19
MED17.1.62 TC1793.....	20
ME17.2 TC1797.....	21
MED17.2 TC1796 .....	22
MEV17.2 TC1796 .....	23
MEVD17.2 TC1797.....	24
ME(V)17.2.1 TC1796.....	25
MEV17.2.2 TC1767 .....	26
MEVD17.2.2 TC1797 .....	27
MEVD17.2.3 TC1793 .....	28
ME17.2.4 TC1793 .....	29
MEVD17.2.4 TC1797 .....	30
MEVD17.2.5 TC1797 .....	31
MEVD17.2.6 TC1797 .....	32
MEVD17.2.7 TC1797 .....	33
MEVD17.2.8/17.2.9 TC1797.....	34
ME17.2.42 TC1793 .....	35
MEVD17.2.G TC1797.....	36
MEVD17.2.H TC1797.....	37
ME17.3 TC1724.....	38
MED17.3.1 TC1766.....	39
MED17.3.4 TC1797.....	40

MED17.3.5 TC1793.....	41
MED/MEV17.4 TC1766.....	42
MED17.4.2 TC1767.....	43
MEV(D)17.4.2 TC1767 .....	44
MED17.4.4 TC1793.....	45
MEVD17.4.4 TC1793 .....	46
ME(V)17.4.5 TC1796.....	47
MEV17.4.6 TC1796.....	48
ME17.5 TC1766.....	49
MED17.5 TC1766 .....	50
MED17.5.1 TC1796.....	51
MED17.5.2 TC1767.....	52
MED17.5.5 TC1766.....	53
ME17.5.6 TC1767 .....	54
MED17.5.20 TC1766.....	55
MED17.5.21 TC1782.....	56
ME17.5.22 TC1724 .....	57
MED17.5.25 TC1782.....	58
ME17.5.26 TC1724 .....	59
ME17.7 TC1796.....	60
MED17.7.1 TC1797.....	61
MED17.7.2 TC1797.....	62
MED17.7.3 TC1797.....	63
MED17.7.3.1 TC1797 .....	64
MED17.7.5 TC1793.....	65
MED17.7.7 TC1793.....	66
MED17.8.2 TC1767.....	67
MEVD17.8.4 TC1797 .....	68
ME17.8.5 TC1762 .....	69
M17.8.7 TC1762.....	70
ME17.8.8/ME17.8.8.1/ME17U6 TC1728/TC1782.....	71
MED17.8.10 TC1728/TC1782.....	72
MED17.8.21 TC1767.....	73
MED17.8.31 TC1797.....	74
ME17.8.32 TC1797 .....	75
MED17.8.32 TC1793.....	76

MED17.8.34/17.8.35 TC1793.....	77
MEDC17.9 TC1793.....	78
ME17.9.1 TC1796 .....	79
MEG17.9.2 TC1767.....	80
MED17.9.3 TC1793.....	81
ME17.9.5 TC1762 .....	82
ME17.9.6 TC1767 .....	83
ME17.9.7 TC1762 .....	84
MED17.9.7 TC1767.....	85
ME(D)17.9.8 TC1767.....	86
MEG17.9.8 TC1767.....	87
MEDG17.9.8 TC1767 .....	88
MED17.9.9 TC1793.....	89
M17.9.11 TC1762 .....	90
ME17.9.11 TC1762 .....	91
MEG17.9.12/17.9.13 TC1762.....	92
ME17.9.20 TC1782 .....	93
MEG17.9.21 TC1724.....	94
ME17.9.21.1 TC1724.....	95
MEG17.9.22.1 TC1724 .....	96
MED17.9.30 TC1793.....	97
MED17.9.32 TC1782.....	98
ME17.9.51 TC1762 .....	99
ME17.9.52 TC1782 .....	100
ME17.9.53 TC1782 .....	101
ME17.9.55 TC1724 .....	102
ME17.9.61 TC1724 .....	103
MED17.9.63 TC1793.....	104
ME17.9.64 TC1724 .....	105
MED17.9.66 TC1793.....	106
ME17.9.71 TC1724 .....	107
ME17.9.74 TC1762 .....	108
EDC17C06 TC1766 .....	109
EDC17C08 TC1766 .....	110
EDC17C10 TC1797 .....	111
EDC17C11 TC1766 .....	112

EDC17C18 TC1766 .....	113
EDC17C19 TC1792 .....	114
EDC17C41 TC1797 .....	115
EDC17C42 TC1767 .....	116
EDC17C43 TC1797 .....	117
EDC17C45 TC1767 .....	118
EDC17C46 TC1767 .....	119
EDC17C47 TC1782 .....	120
EDC17C49 TC1797 .....	121
EDC17C50 TC1797 .....	123
EDC17C53 TC1767 .....	124
EDC17C54 TC1797 .....	125
EDC17C55 TC1767 .....	126
EDC17C56 TC1797 .....	127
EDC17C57 TC1793 .....	128
EDC17C58 TC1793 .....	129
EDC17C59 TC1767 .....	130
EDC17C60 TC1793 .....	131
EDC17C63 TC1724 .....	132
EDC17C64 TC1797 .....	133
EDC17C66 TC1793 .....	134
EDC17C69 TC1793 .....	135
EDC17C70 TC1793 .....	136
EDC17C73 TC1793 .....	137
EDC17C74 TC1793 .....	138
EDC17C76 TC1793 .....	139
EDC17C79 TC1797 .....	140
EDC17C81 TC1782 .....	141
EDC17C83 TC1793 .....	142
EDC17C84 TC1782 .....	143
EDC17CP01 TC1796 .....	144
EDC17CP02 TC1766 .....	145
EDC17CP04 TC1796 .....	146
EDC17CP05 TC1796/TC1797 .....	147
EDC17CP06 TC1796 .....	148
EDC17CP07 TC1766 .....	149

EDC17CP09 TC1796 .....	150
EDC17CP10 TC1796 .....	151
EDC17CP11 TC1796 .....	152
EDC17CP14 TC1796 .....	153
EDC17CP15 TC1796 .....	154
EDC17CP16 TC1797 .....	155
EDC17CP18 TC1796 .....	156
EDC17CP19 TC1792 .....	157
EDC17CP20 TC1796 .....	158
EDC17CP21 TC1792 .....	159
EDC17CP22 TC1796 .....	160
EDC17CP24 TC1796 .....	161
EDC17CP27 TC1796 .....	162
EDC17CP37 TC1766 .....	163
EDC17CP42 TC1797 .....	164
EDC17CP44 TC1797 .....	165
EDC17CP45 TC1797 .....	166
EDC17CP46 TC1797 .....	167
EDC17CP47 TC1797 .....	168
EDC17CP48 TC1797 .....	169
EDC17CP49 TC1797 .....	170
EDC17CP50 TC1797 .....	171
EDC17CP52 TC1797 .....	172
EDC17CP54 AMAROK TC1793 .....	173
EDC17CP54 AUDI TC1793.....	174
EDC17CP55 TC1793 .....	175
EDC17CP57 TC1793 .....	176
EDC17CP58 TC1767 .....	177
EDC17CP60 TC1793 .....	178
EDC17CP62 TC1793 .....	179
EDC17CP65 TC1793 .....	180
EDC17CP68 TC1797 .....	181
EDC17CP74 TC1793 .....	182
EDC17CV41 TC1797.....	183
EDC17CV42 TC1797 .....	185
EDC17CV43/CV44 TC1767 .....	187

EDC17CV45 TC1782.....	188
EDC17CV52 TC1797 .....	189
EDC17CV53/CV54/CV56 TC1767.....	190
EDC17U01 TC1766 .....	191
EDC17U05 TC1766 .....	192
DCU17CV51 TC1724.....	193
DCU17HD01 TC1766.....	194
DCU17PC01 TC1766.....	195
DCU17PC42/PC43 TC1724 .....	196





# PCMflash

Engine Control Unit

## MEDG17.0 TC1797

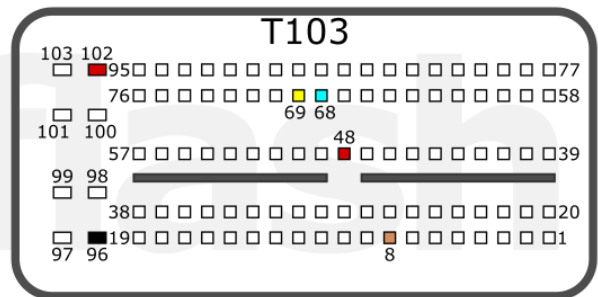
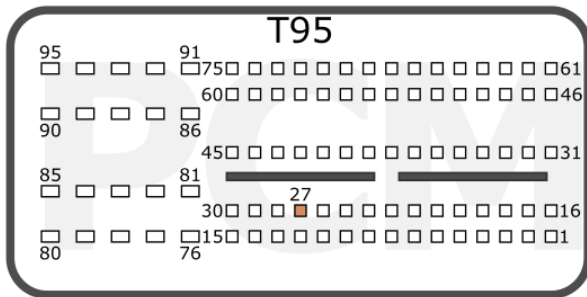

<b>+12V</b>	T103: 102, 48	<b>CAN-L</b>	T103: 68
<b>GND</b>	T103: 96	<b>CAN-H</b>	T103: 69
<b>GPT</b>	T103:8, T95: 27		

FORD

pcmflash.ru

v.1

2021-09-30

# PCMflash

Engine Control Unit

## MED17.0.1 TC1767

### Connection version 1

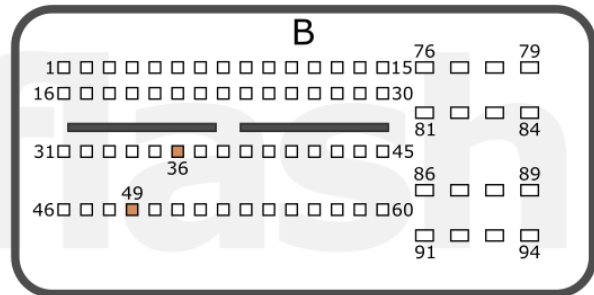
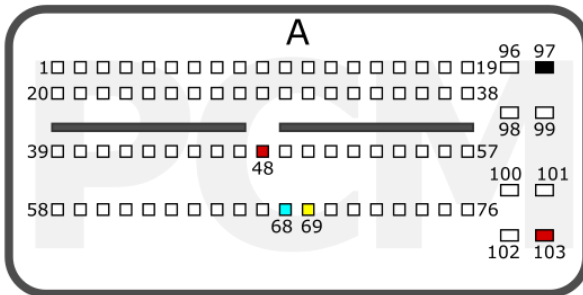

<b>+12V</b>	A: 48, 103	<b>CAN-L</b>	A: 68
<b>GND</b>	A: 97	<b>CAN-H</b>	A: 69
<b>GPT</b>	B: 36, 49		

### Connection version 2

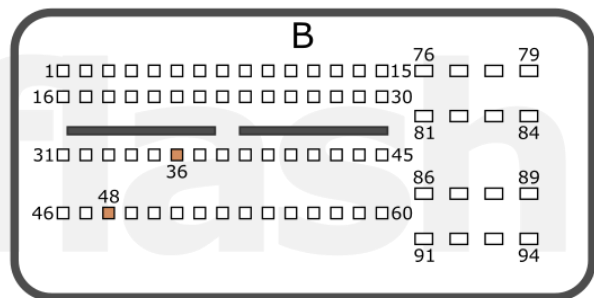
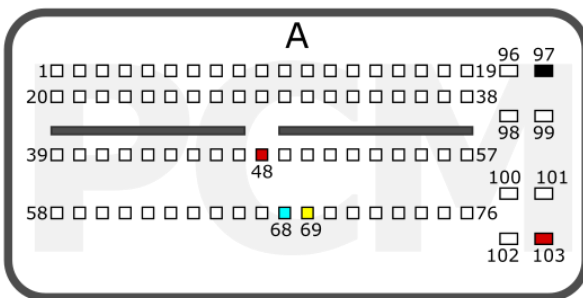

<b>+12V</b>	A: 48, 103	<b>CAN-L</b>	A: 68
<b>GND</b>	A: 97	<b>CAN-H</b>	A: 69
<b>GPT</b>	B: 36, 48		

FORD





# PCMflash

Engine Control Unit

## MED17.1.1 TC1797

### AUDI

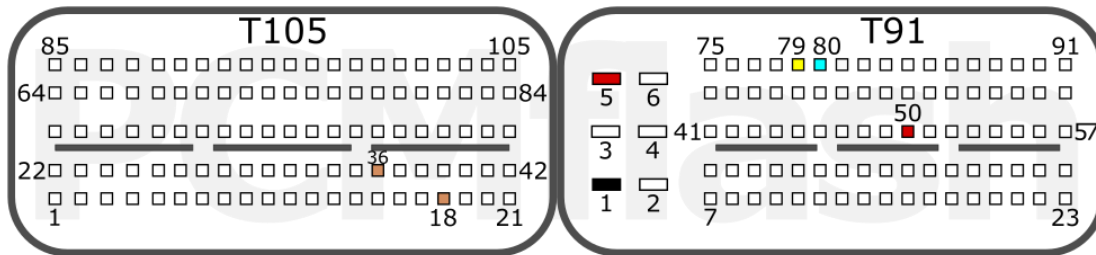

<b>+12V</b>	T91: 5, 50	<b>CAN-L</b>	T91: 80
<b>GND</b>	T91: 1	<b>CAN-H</b>	T91: 79
<b>GPT</b>	T105: 18, 36		

### VOLKSWAGEN

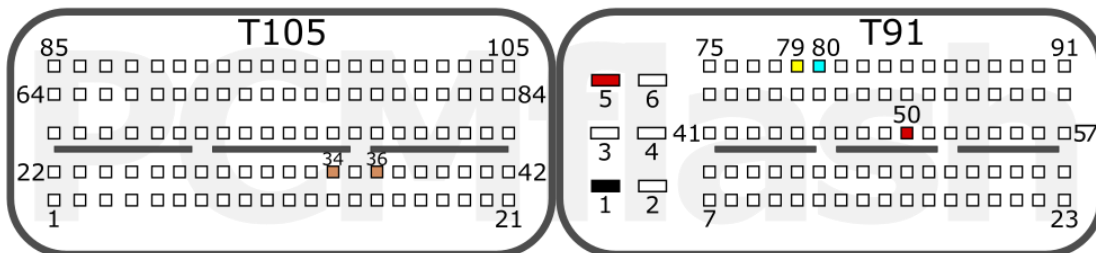

<b>+12V</b>	T91: 5, 50	<b>CAN-L</b>	T91: 80
<b>GND</b>	T91: 1	<b>CAN-H</b>	T91: 79
<b>GPT</b>	T105: 34, 36		

### VAG

# PCMflash

Engine Control Unit

## MED17.1.6 TC1797

### VAG

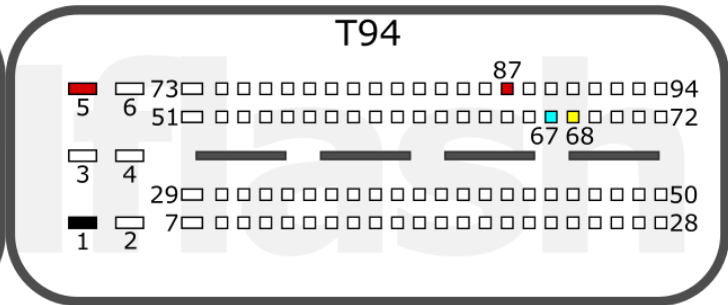
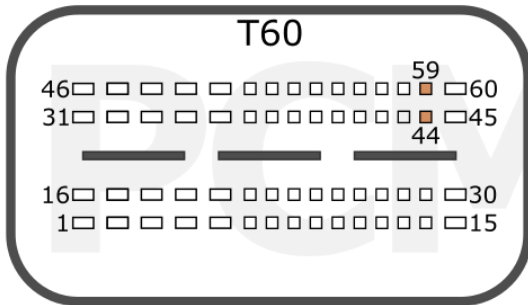

<b>+12V</b>	T94: 5, 87	<b>CAN-L</b>	T94: 67
<b>GND</b>	T94: 1	<b>CAN-H</b>	T94: 68
<b>GPT</b>	T60: 44, 59		

### PORSCHE

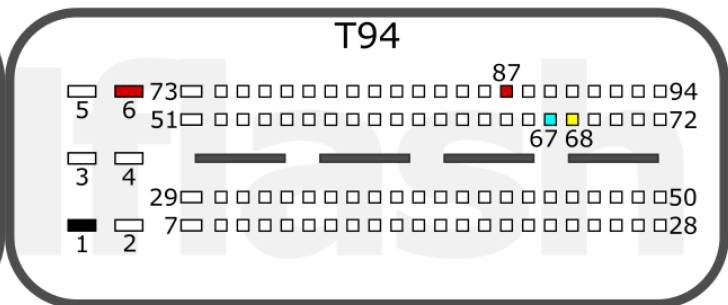
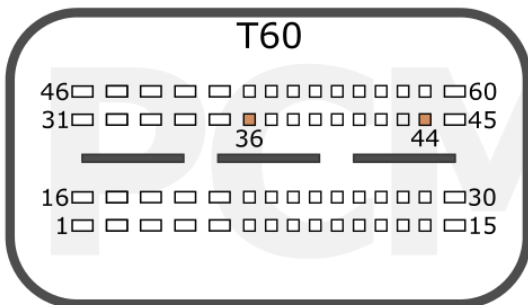

<b>+12V</b>	T94: 6, 87	<b>CAN-L</b>	T94: 67
<b>GND</b>	T94: 1	<b>CAN-H</b>	T94: 68
<b>GPT</b>	T60: 44, 36		

PORSCHE

VAG

pcmflash.ru

v.1

2021-09-11

# PCMflash

Engine Control Unit

## MED17.1.10 TC1793

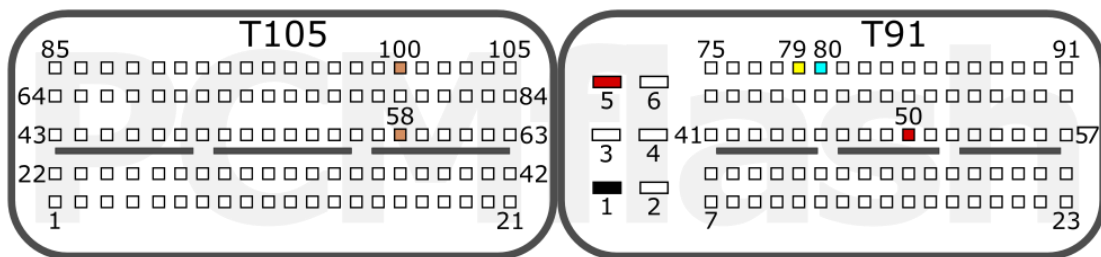

<b>+12V</b>	T91: 5, 50	<b>CAN-L</b>	T91: 80
<b>GND</b>	T91: 1	<b>CAN-H</b>	T91: 79
<b>GPT</b>	T105: 100, 58		

AUDI

pcmflash.ru

v.1

2021-09-11

# PCMflash

Engine Control Unit

## MED17.1.11 TC1797

T105

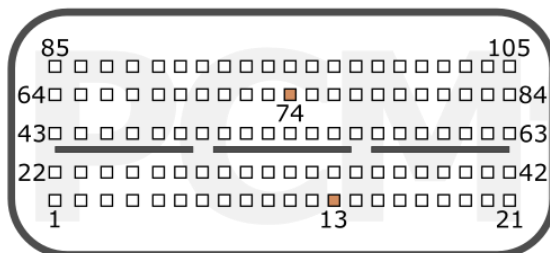

T91

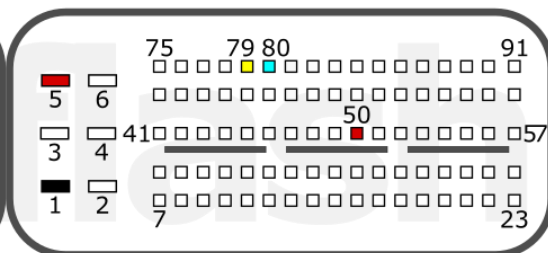

<b>+12V</b>	T91: 5, 50	<b>CAN-L</b>	T91: 80
<b>GND</b>	T91: 1	<b>CAN-H</b>	T91: 79
<b>GPT</b>	T105: 74, 13		

PORSCHE

pcmflash.ru

v.1

2024-08-09



# PCMflash

Engine Control Unit

## MED17.1.21 TC1793

### Connection version 1

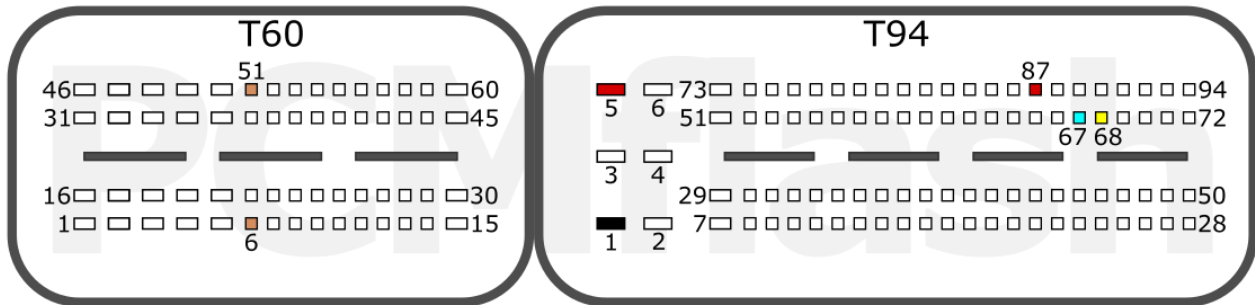

<b>+12V</b>	T94: 5, 87	<b>CAN-L</b>	T94: 67
<b>GND</b>	T94: 1	<b>CAN-H</b>	T94: 68
<b>GPT</b>	T60: 51, 6		

### Connection version 2

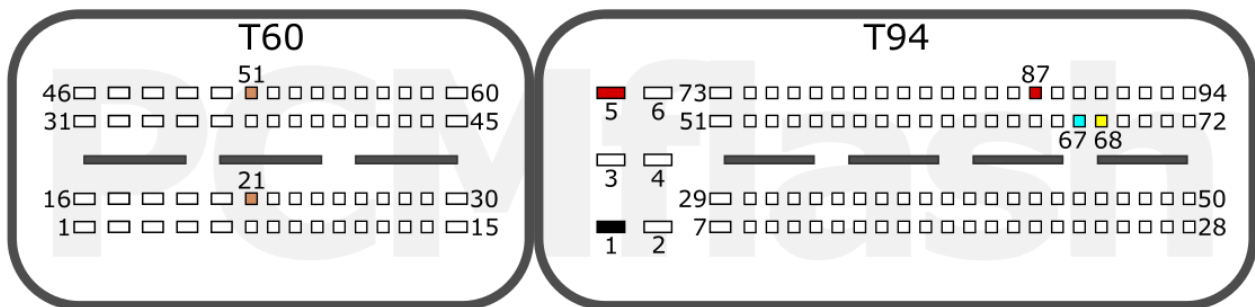

<b>+12V</b>	T94: 5, 87	<b>CAN-L</b>	T94: 67
<b>GND</b>	T94: 1	<b>CAN-H</b>	T94: 68
<b>GPT</b>	T60: 21, 51		

VAG

pcmflash.ru

v.1

2021-10-14



# PCMflash

Engine Control Unit

## MED17.1.61 TC1793

### Connection version 1

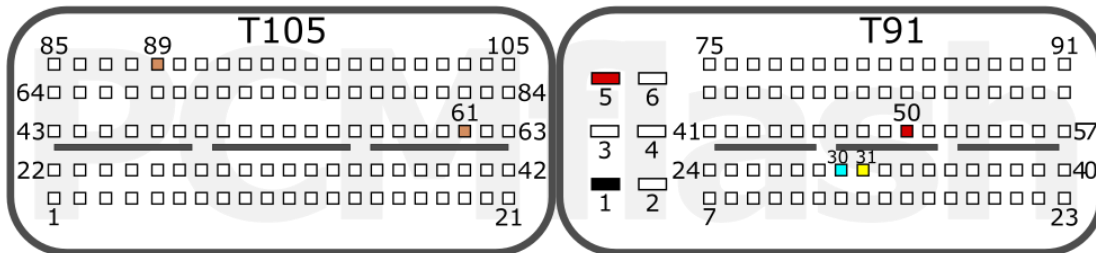

<b>+12V</b>	T91: 5, 50	<b>CAN-L</b>	T91: 30
<b>GND</b>	T91: 1	<b>CAN-H</b>	T91: 31
<b>GPT</b>	T105: 61, 89		

### Connection version 2

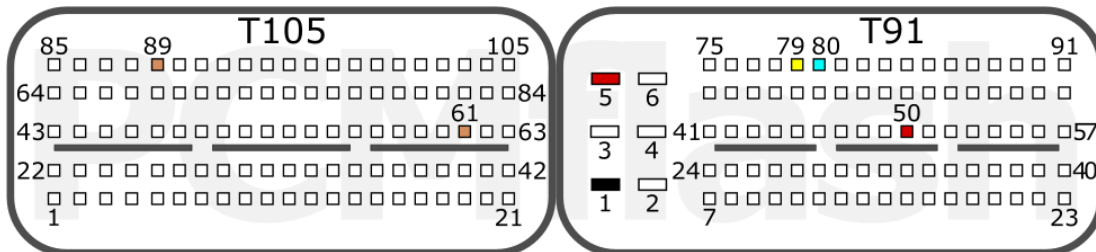

<b>+12V</b>	T91: 5, 50	<b>CAN-L</b>	T91: 80
<b>GND</b>	T91: 1	<b>CAN-H</b>	T91: 79
<b>GPT</b>	T105: 61, 89		

VAG

pcmflash.ru

v.2

2024-05-08

# PCMflash

Engine Control Unit

## MED17.1.62 TC1793

### VOLKSWAGEN

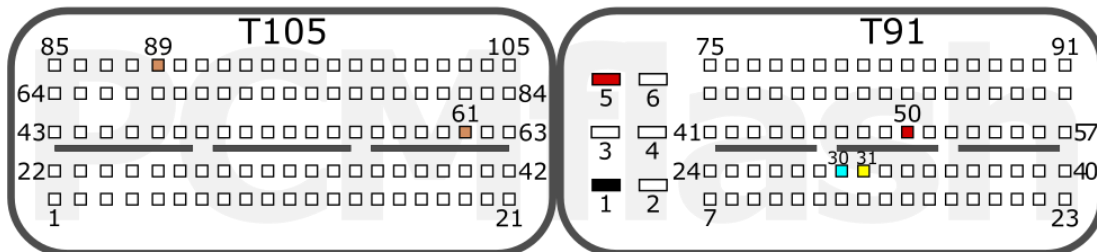

<b>+12V</b>	T91: 5, 50	<b>CAN-L</b>	T91: 30
<b>GND</b>	T91: 1	<b>CAN-H</b>	T91: 31
<b>GPT</b>	T105: 61, 89		

### AUDI

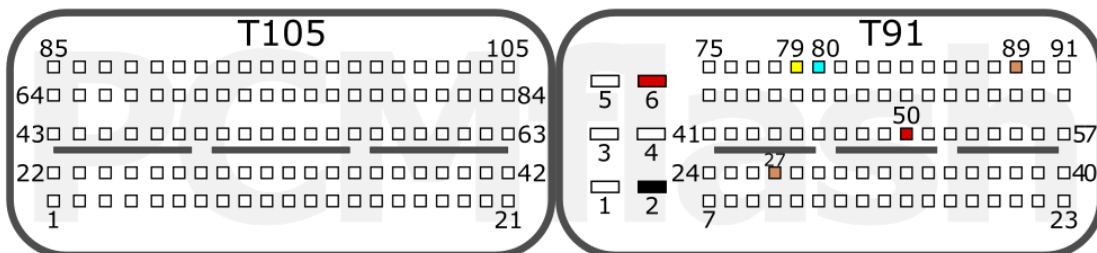

<b>+12V</b>	T91: 6, 50	<b>CAN-L</b>	T91: 80
<b>GND</b>	T91: 2	<b>CAN-H</b>	T91: 79
<b>GPT</b>	T105: 27, 89		

### BENTLEY

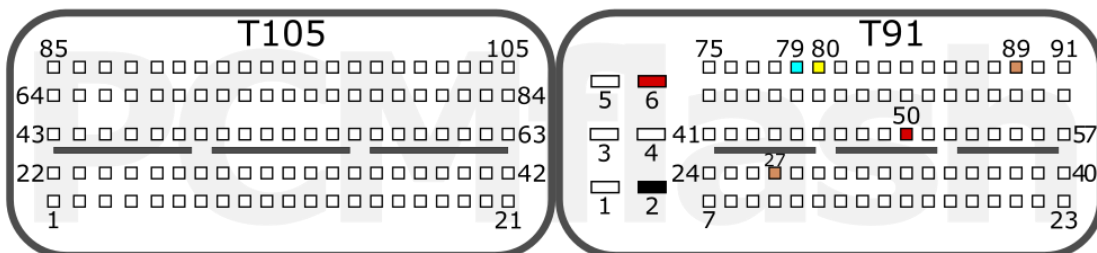

<b>+12V</b>	T91: 6, 50	<b>CAN-L</b>	T91: 79
<b>GND</b>	T91: 2	<b>CAN-H</b>	T91: 80
<b>GPT</b>	T105: 27, 89		

### VAG



# PCMflash

Engine Control Unit

## MED17.2 TC1796

### Connection version 1

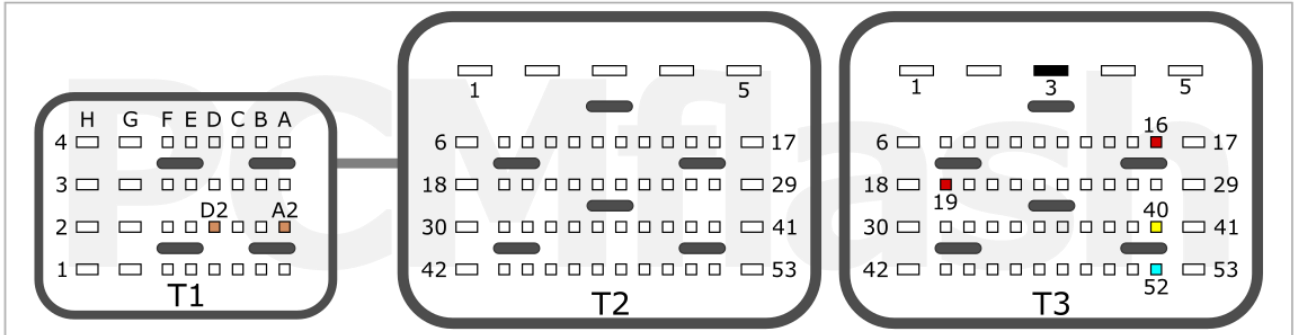

<b>+12V</b>	T3: 16, 19	<b>CAN-L</b>	T3: 52
<b>GND</b>	T3: 3	<b>CAN-H</b>	T3: 40
<b>GPT</b>	T1: A2, D2		

### Connection version 2

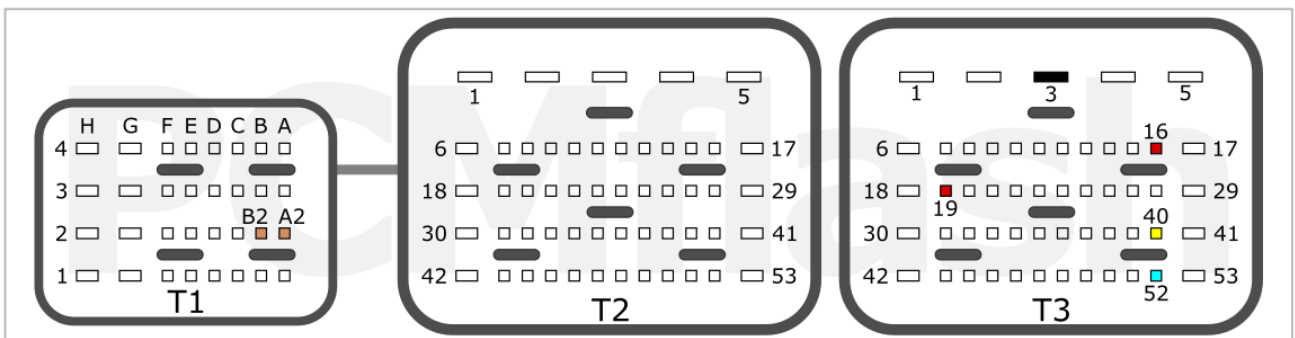

<b>+12V</b>	T3: 16, 19	<b>CAN-L</b>	T3: 52
<b>GND</b>	T3: 3	<b>CAN-H</b>	T3: 40
<b>GPT</b>	T1: B2, A2		

MINI

pcmflash.ru

v.1

2021-11-01

# PCMflash

Engine Control Unit

## MEV17.2 TC1796

### TYPE 1



<b>+12V</b>	T58: 1, 7	<b>CAN-L</b>	T58: 33
<b>GND</b>	T58: 6	<b>CAN-H</b>	T58: 46
<b>GPT</b>	T96: 22, 23		

### TYPE 2

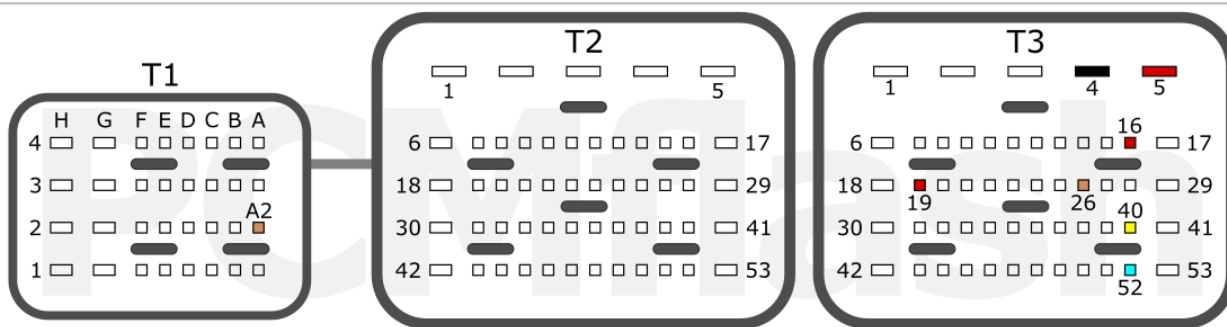

<b>+12V</b>	T3: 5, 16, 19	<b>CAN-L</b>	T3: 52
<b>GND</b>	T3: 4	<b>CAN-H</b>	T3: 40
<b>GPT</b>	T1: A2, T3: 26		

BMW

# PCMflash

Engine Control Unit

## MEVD17.2 TC1797

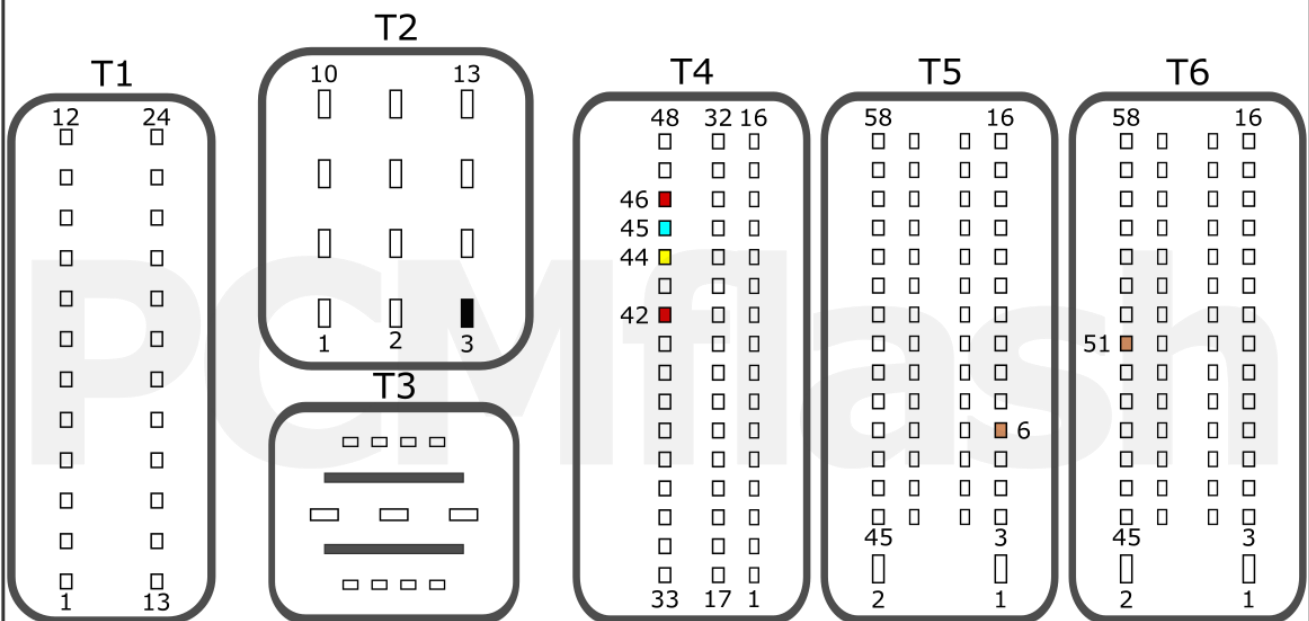

<b>+12V</b>	T4: 42, 46	<b>CAN-L</b>	T4: 45
<b>GND</b>	T2: 3	<b>CAN-H</b>	T4: 44
<b>GPT</b>	T6: 51, T5: 6		

BMW

pcmflash.ru

v.1

2021-09-04



# PCMflash

Engine Control Unit

## ME(V)17.2.1 TC1796

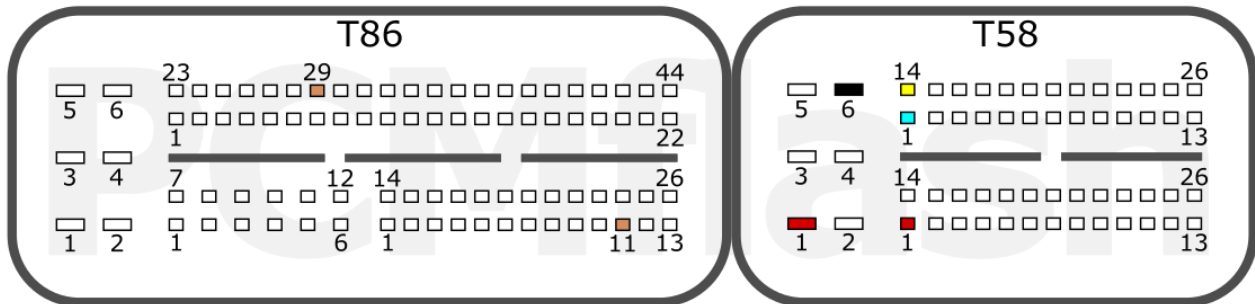

<b>+12V</b>	T58: 1, 1	<b>CAN-L</b>	T58: 1
<b>GND</b>	T58: 6	<b>CAN-H</b>	T58: 14
<b>GPT</b>	T86: 29, 11		

BMW

pcmflash.ru

v.2

2021-12-14

# PCMflash

Engine Control Unit

## MEV17.2.2 TC1767

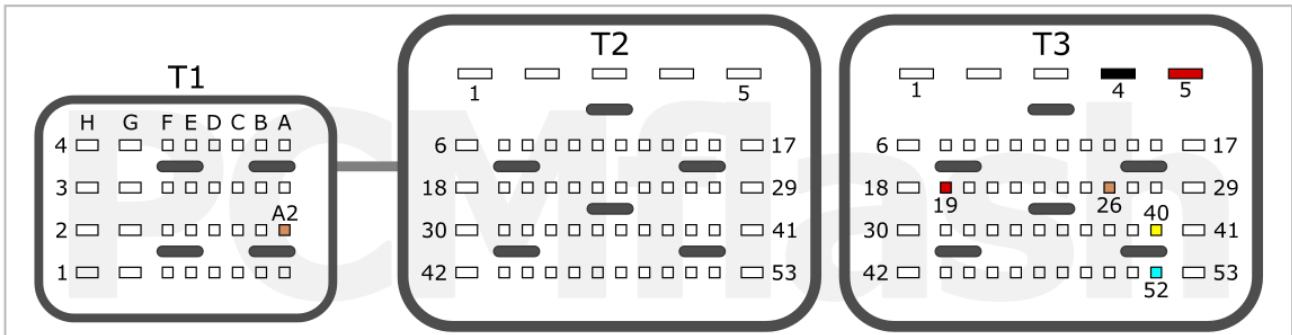

<b>+12V</b>	T3: 5, 19	<b>CAN-L</b>	T3: 52
<b>GND</b>	T3: 4	<b>CAN-H</b>	T3: 40
<b>GPT</b>	T1: A2, T3:26		

BMW

pcmflash.ru

v.1

2021-10-10

# PCMflash

Engine Control Unit

## MEVD17.2.2 TC1797

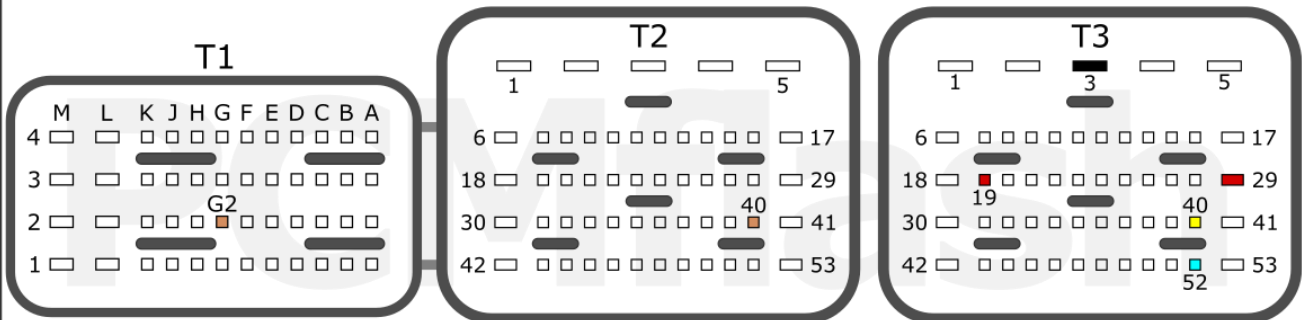

<b>+12V</b>	T3: 19, 29	<b>CAN-L</b>	T3: 52
<b>GND</b>	T3: 3	<b>CAN-H</b>	T3: 40
<b>GPT</b>	T2: 40, T1: G2		

MINI

pcmflash.ru

v.1

2021-10-22

# PCMflash

Engine Control Unit

## MEVD17.2.3 TC1793

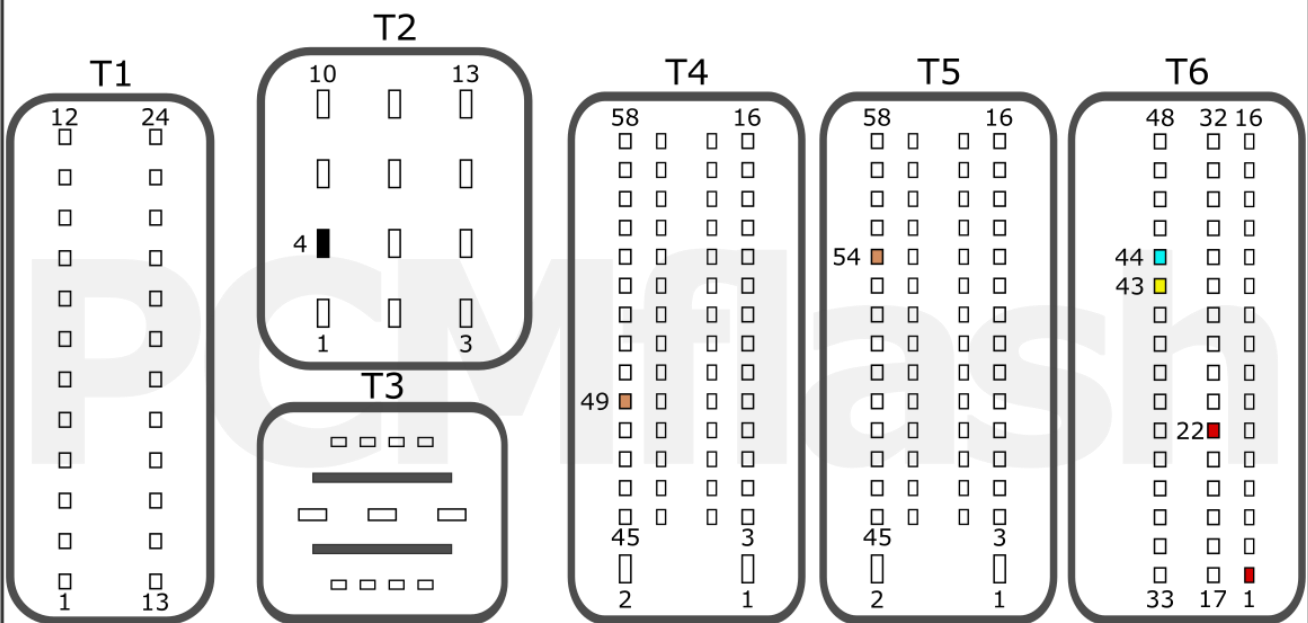

<b>+12V</b>	T6: 22, 1	<b>CAN-L</b>	T6: 44
<b>GND</b>	T2: 4	<b>CAN-H</b>	T6: 43
<b>GPT</b>	T5: 54, T4: 49		

BMW

pcmflash.ru

v.1

2021-08-24



# PCMflash

Engine Control Unit

## MEVD17.2.4 TC1797

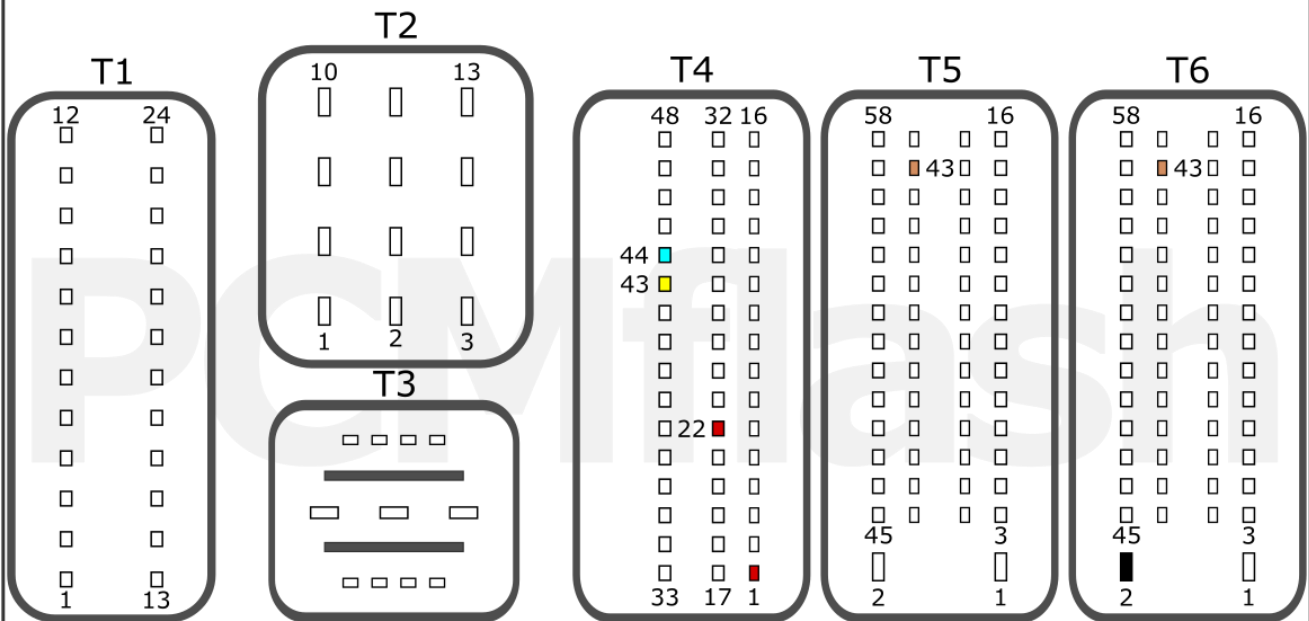

<b>+12V</b>	T4: 1, 22	<b>CAN-L</b>	T4: 44
<b>GND</b>	T6: 2	<b>CAN-H</b>	T4: 43
<b>GPT</b>	T5: 43, T6: 43		

BMW

pcmflash.ru

v.1

2021-09-16

# PCMflash

Engine Control Unit

## MEVD17.2.5 TC1797

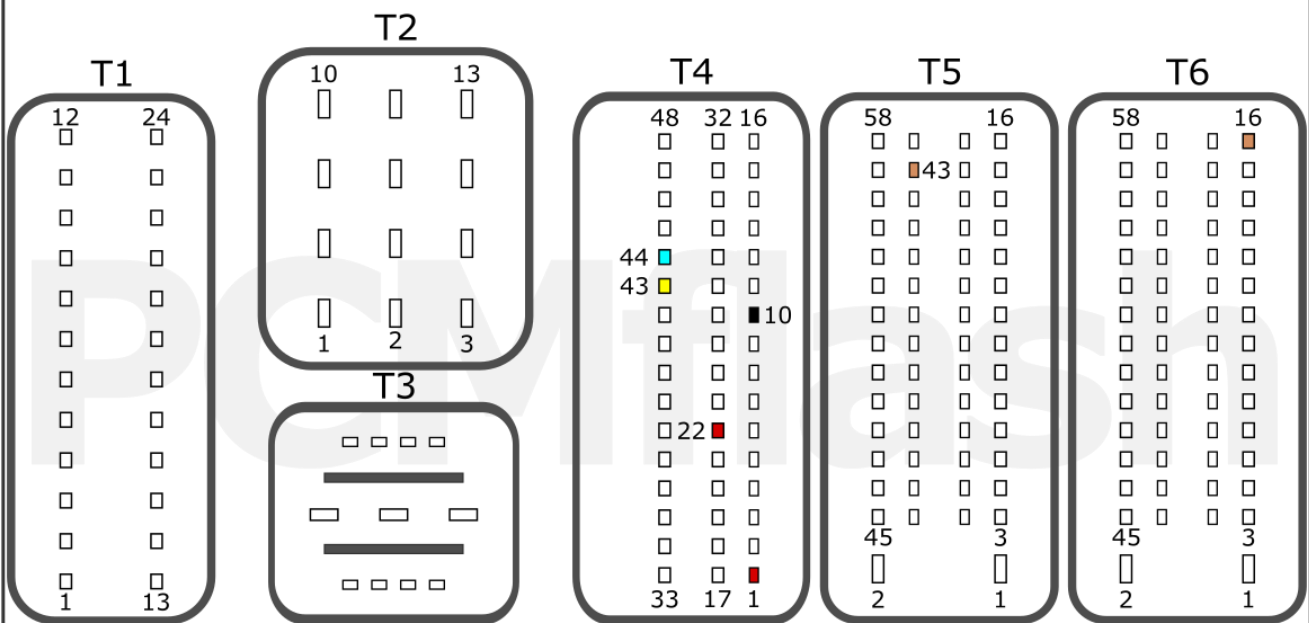

<b>+12V</b>	T4: 22, 1	<b>CAN-L</b>	T4: 44
<b>GND</b>	T4: 10	<b>CAN-H</b>	T4: 43
<b>GPT</b>	T6: 16, T5: 43		

BMW

pcmflash.ru

v.1

2021-10-11

# PCMflash

Engine Control Unit

## MEVD17.2.6 TC1797

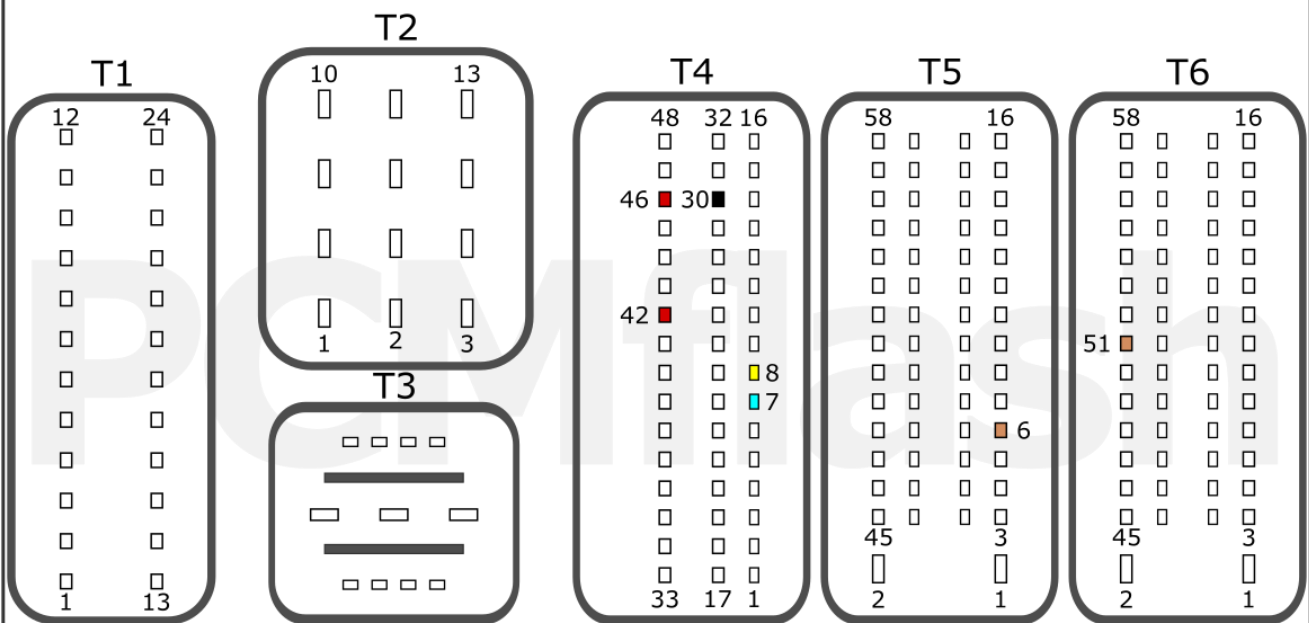

<b>+12V</b>	T4: 42, 46	<b>CAN-L</b>	T4: 7
<b>GND</b>	T4: 30	<b>CAN-H</b>	T4: 8
<b>GPT</b>	T5: 6, T6: 51		

BMW

pcmflash.ru

v.1

2021-08-29



# PCMflash

Engine Control Unit

## MEVD17.2.7 TC1797

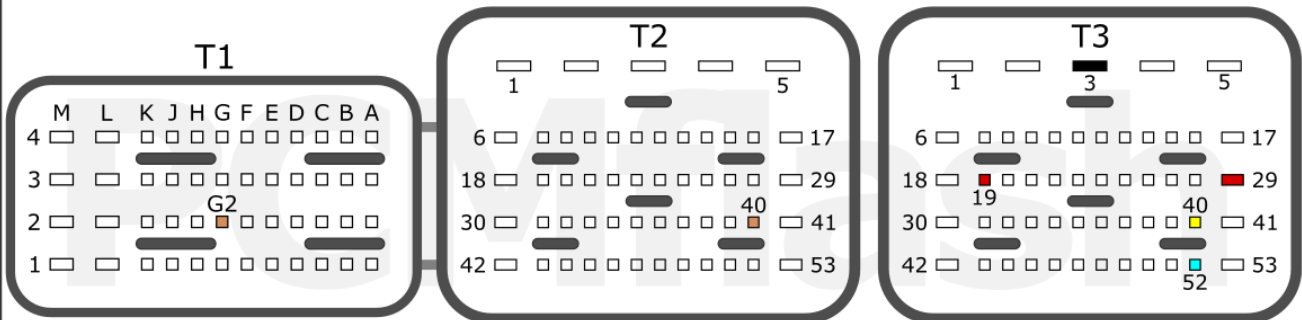

<b>+12V</b>	T3: 19, 29	<b>CAN-L</b>	T3: 52
<b>GND</b>	T3: 3	<b>CAN-H</b>	T3: 40
<b>GPT</b>	T2: 40, T1: G2		

MINI

pcmflash.ru

v.1

2021-10-12

# PCMflash

Engine Control Unit

MEVD17.2.8/17.2.9 TC1797

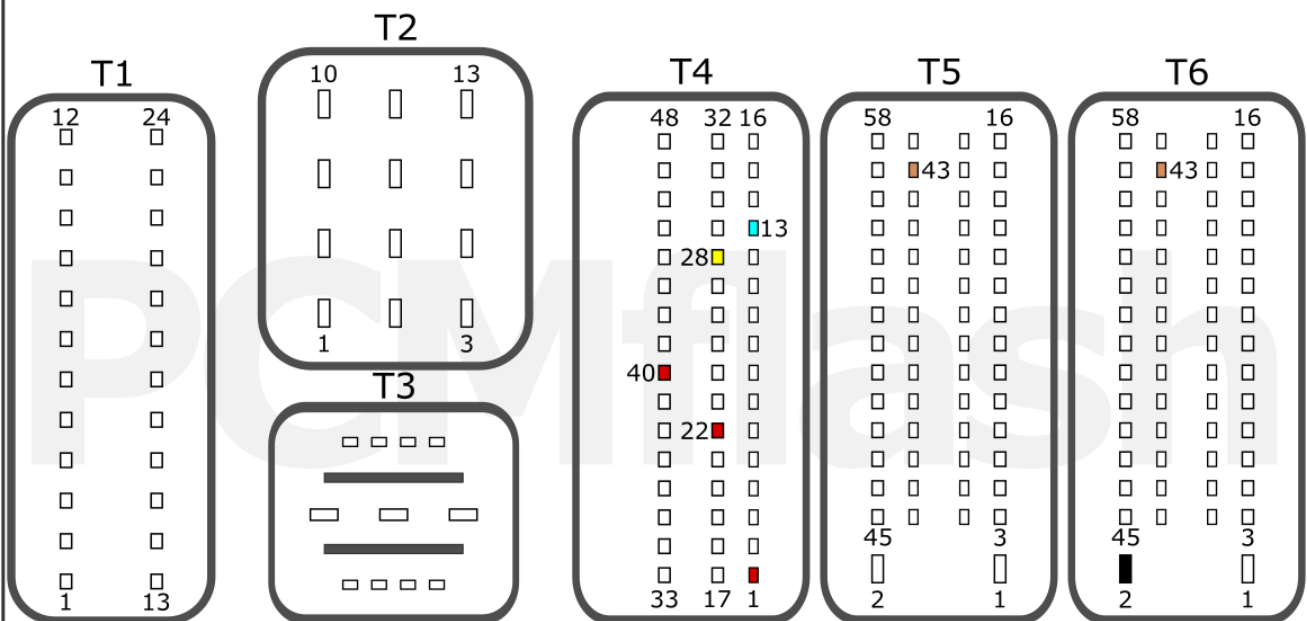

<b>+12V</b>	T4: 40, 22, 1	<b>CAN-L</b>	T4: 13
<b>GND</b>	T6: 2	<b>CAN-H</b>	T4: 28
<b>GPT</b>	T6: 43, T5: 43		

BMW

pcmflash.ru

v.2

2022-01-24

# PCMflash

Engine Control Unit  
**ME17.2.42 TC1793**

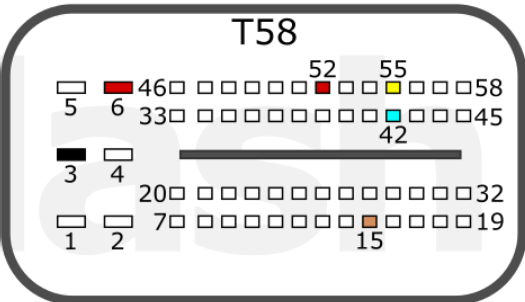
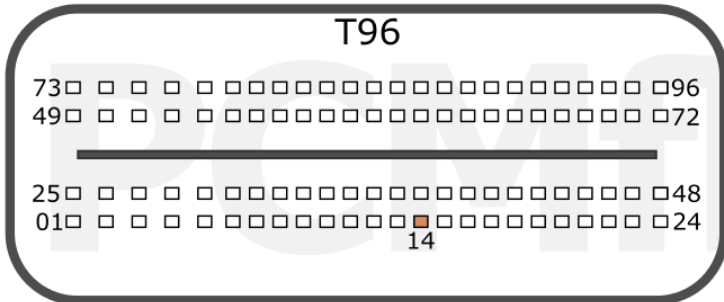

<b>+12V</b>	T58: 6, 52	<b>CAN-L</b>	T58: 42
<b>GND</b>	T58: 3	<b>CAN-H</b>	T58: 55
<b>GPT</b>	T96: 14; T58: 15		

BMW

# PCMflash

Engine Control Unit

## MEVD17.2.G TC1797

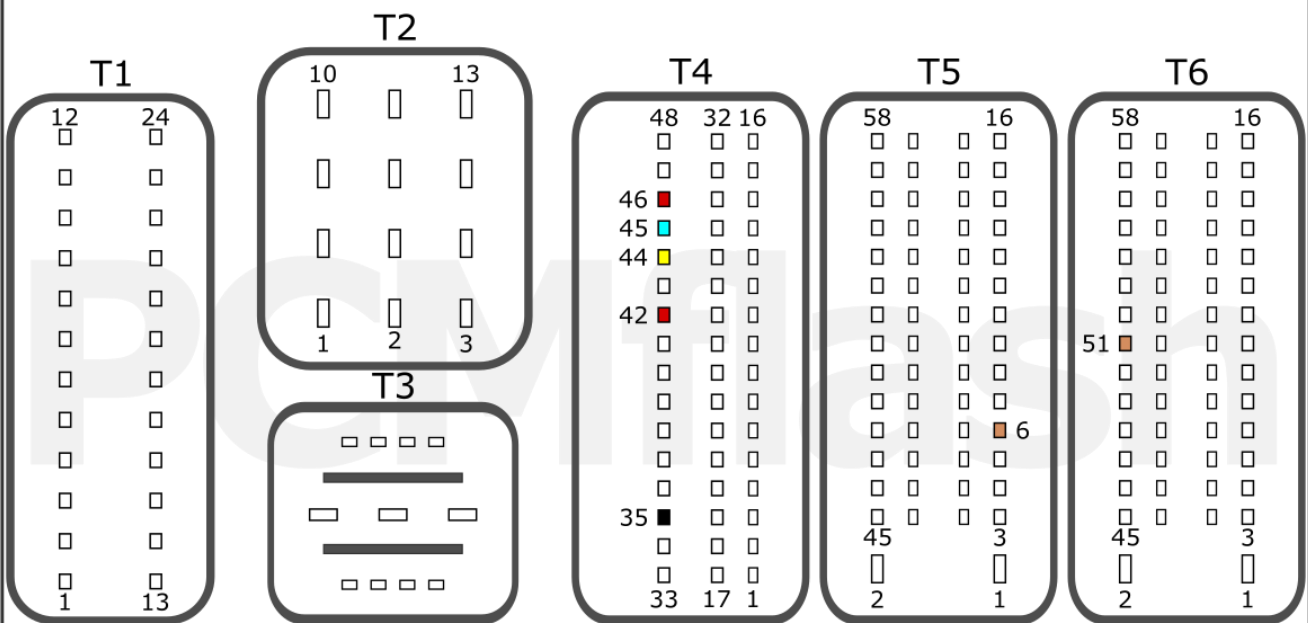

<b>+12V</b>	T4: 42, 46	<b>CAN-L</b>	T4: 45
<b>GND</b>	T4: 35	<b>CAN-H</b>	T4: 44
<b>GPT</b>	T6: 51, T5: 6		

BMW

pcmflash.ru

v.1

2021-10-08

# PCMflash

Engine Control Unit

## MEVD17.2.H TC1797

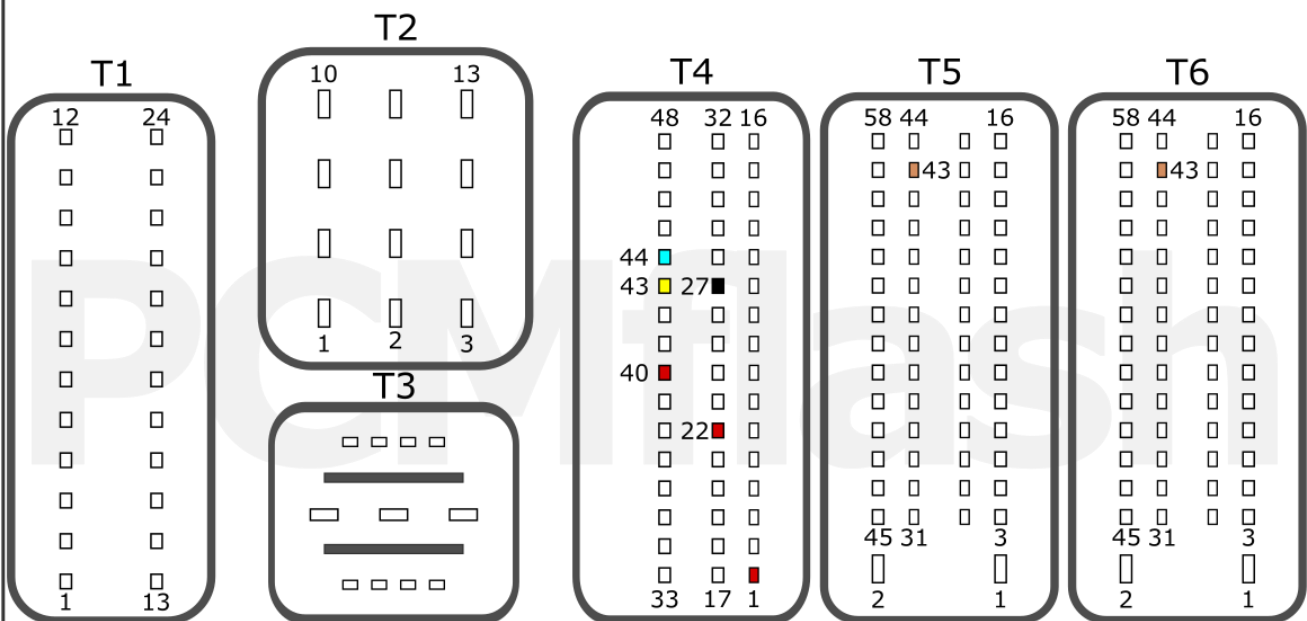

<b>+12V</b>	T4: 1, 22, 40	<b>CAN-L</b>	T4: 44
<b>GND</b>	T4: 27	<b>CAN-H</b>	T4: 43
<b>GPT</b>	T5: 43, T6: 43		

BMW

pcmflash.ru

v.1

2021-10-31

# PCMflash

Engine Control Unit

## ME17.3 TC1724

### FIAT

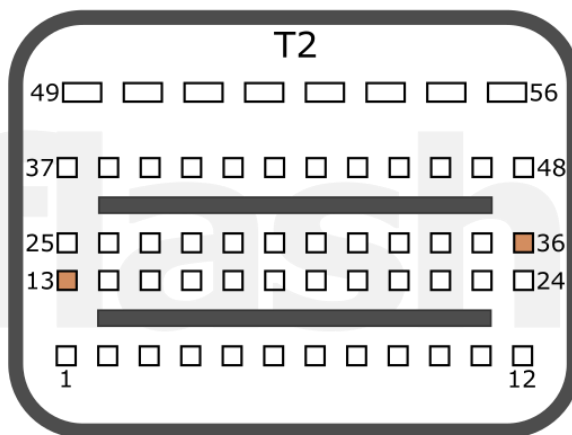
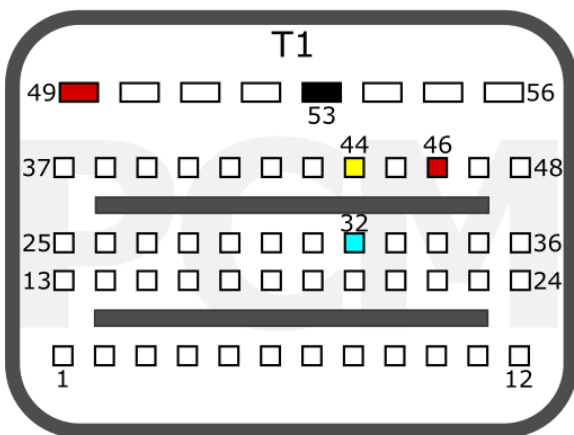

<b>+12V</b>	T1: 49, 46	<b>CAN-L</b>	T1: 32
<b>GND</b>	T1: 53	<b>CAN-H</b>	T1: 44
<b>GPT</b>	T2: 36, 13		

### OPEL

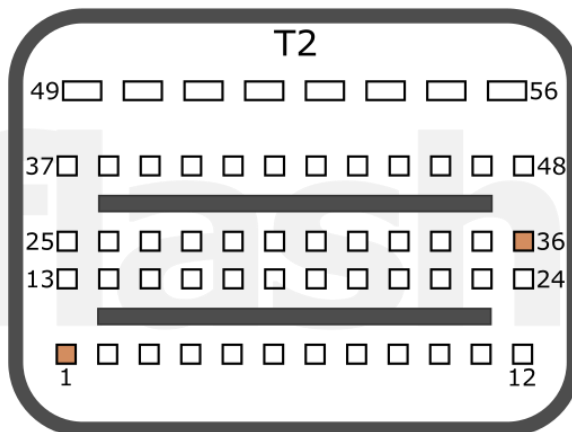
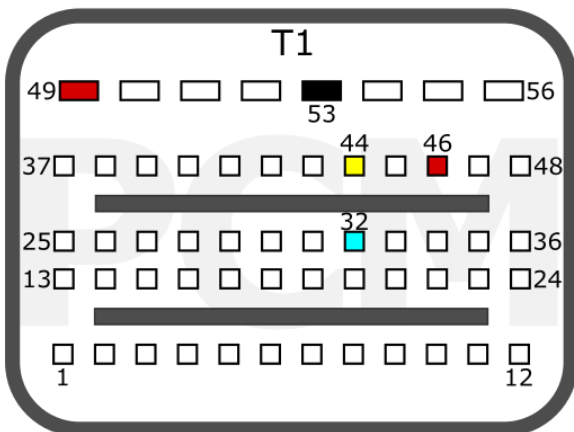

<b>+12V</b>	T1: 49, 46	<b>CAN-L</b>	T1: 32
<b>GND</b>	T1: 53	<b>CAN-H</b>	T1: 44
<b>GPT</b>	T2: 36, 1		

FIAT

OPEL

pcmflash.ru

v.1

2021-10-31

# PCMflash

Engine Control Unit

## MED17.3.1 TC1766

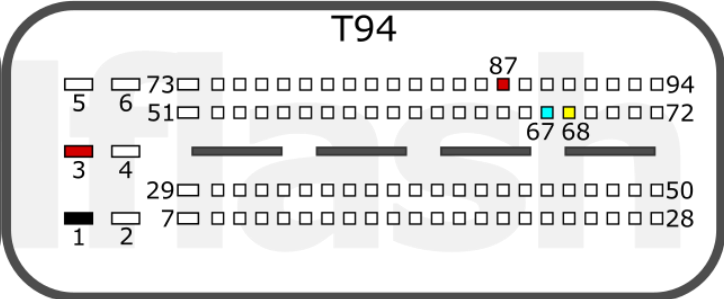
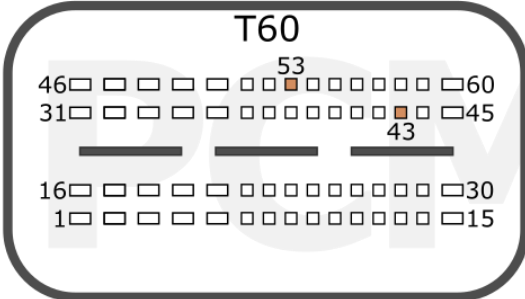

<b>+12V</b>	T94: 3, 87	<b>CAN-L</b>	T94: 67
<b>GND</b>	T94: 1	<b>CAN-H</b>	T94: 68
<b>GPT</b>	T60: 53, 43		

LANCIA

pcmflash.ru

v.1

2021-10-12

# PCMflash

Engine Control Unit

## MED17.3.4 TC1797

T105

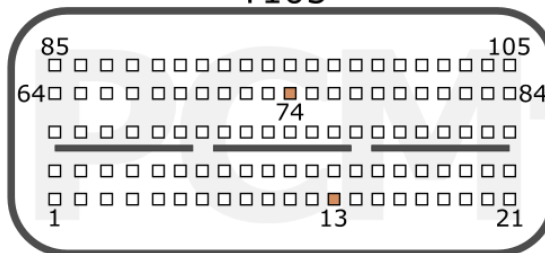

T91

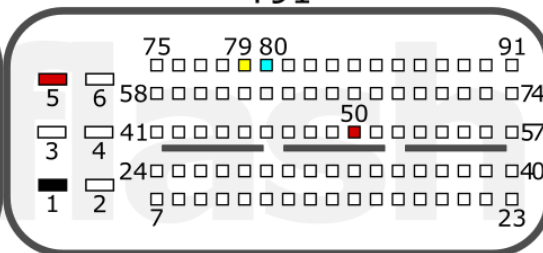

<b>+12V</b>	T91: 5, 50	<b>CAN-L</b>	T91: 80
<b>GND</b>	T91: 1	<b>CAN-H</b>	T91: 79
<b>GPT</b>	T105: 13, 74		

MASERATI

pcmflash.ru

v.1

2021-10-11



# PCMflash

Engine Control Unit

## MED17.3.5 TC1793

T105

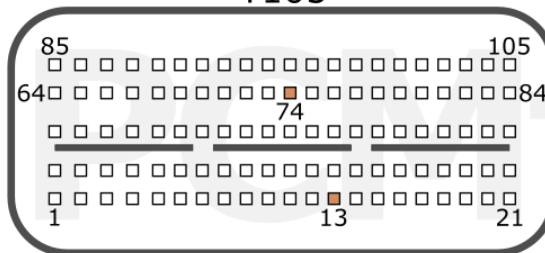

T91

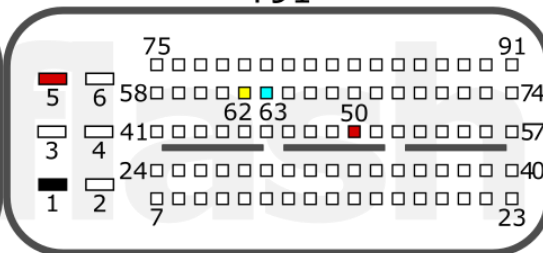

<b>+12V</b>	T91: 5, 50	<b>CAN-L</b>	T91: 63
<b>GND</b>	T91: 1	<b>CAN-H</b>	T91: 62
<b>GPT</b>	T105: 74, 13		

FERRARI

pcmflash.ru

v.1

2021-12-03

# PCMflash

Engine Control Unit

## MED/MEV17.4 TC1766

### Connection version 1

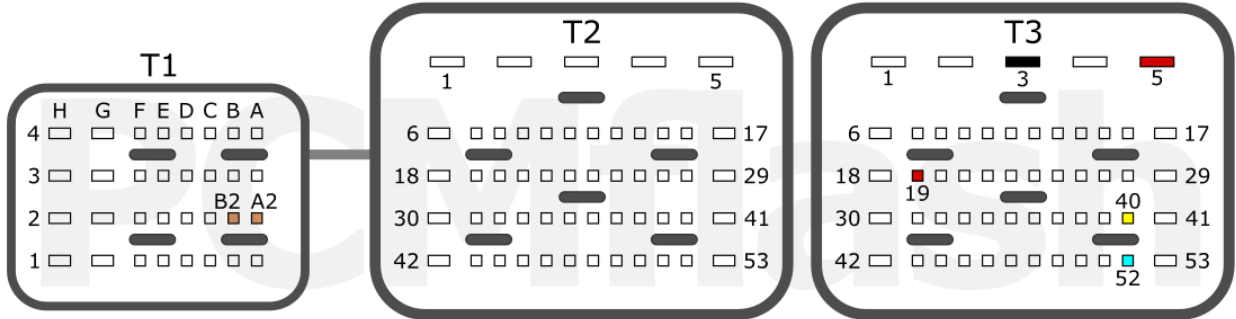

<b>+12V</b>	T3: 5, 19	<b>CAN-L</b>	T3: 52
<b>GND</b>	T3: 3	<b>CAN-H</b>	T3: 40
<b>GPT</b>	T1: A2, B2		

### Connection version 2

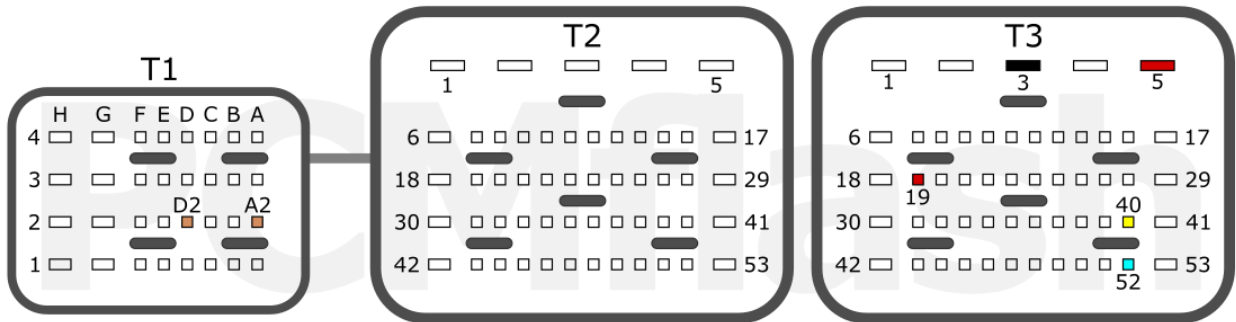

<b>+12V</b>	T3: 5, 19	<b>CAN-L</b>	T3: 52
<b>GND</b>	T3: 3	<b>CAN-H</b>	T3: 40
<b>GPT</b>	T1: A2, D2		

### Connection version 3

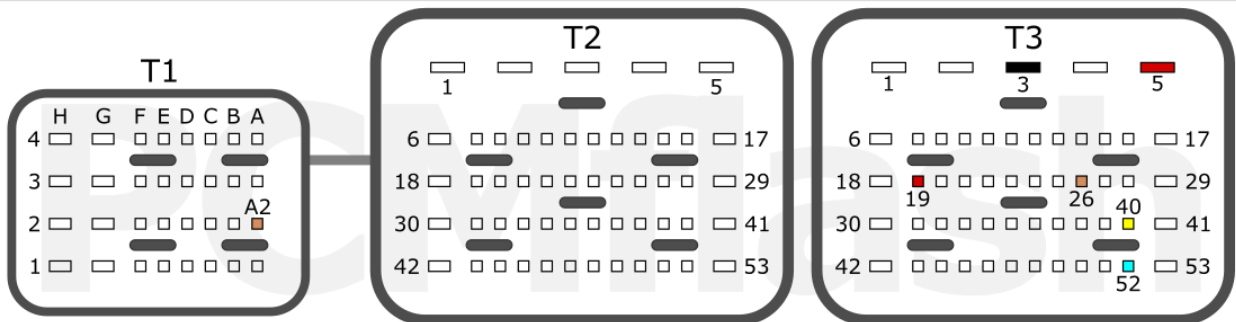

<b>+12V</b>	T3: 5, 19	<b>CAN-L</b>	T3: 52
<b>GND</b>	T3: 3	<b>CAN-H</b>	T3: 40
<b>GPT</b>	T1: 26, A2		

PSA

# PCMflash

Engine Control Unit

## MED17.4.2 TC1767

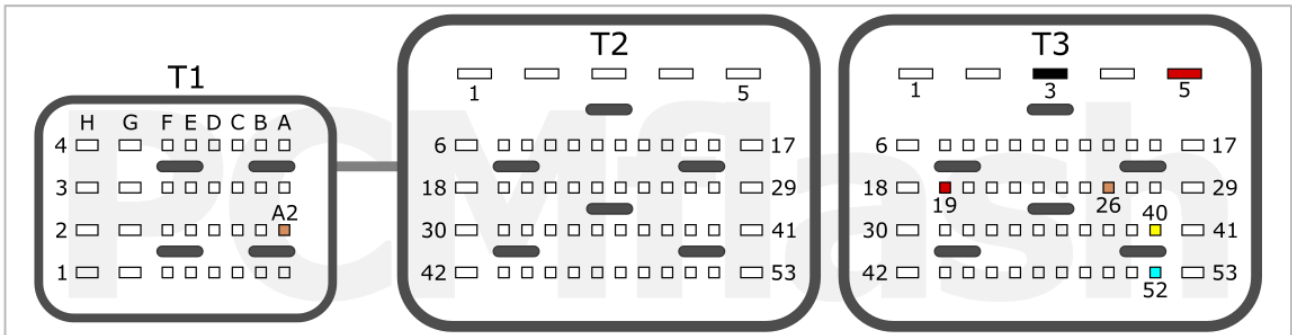

<b>+12V</b>	T3: 5, 19	<b>CAN-L</b>	T3: 52
<b>GND</b>	T3: 3	<b>CAN-H</b>	T3: 40
<b>GPT</b>	T1: A2, T3: 26		

PSA

pcmflash.ru

v.4

2025.03.11

# PCMflash

Engine Control Unit

MEV(D)17.4.2 TC1767

## Connection version 1

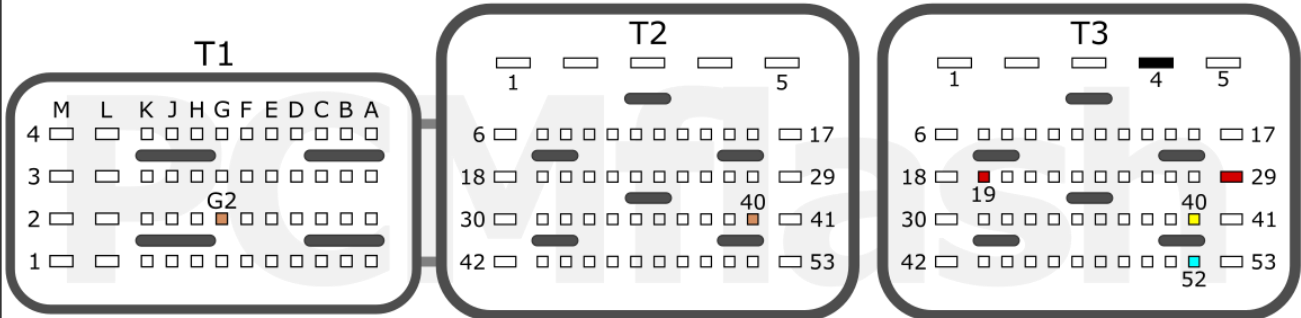

<b>+12V</b>	T3: 19, 29	<b>CAN-L</b>	T3: 52
<b>GND</b>	T3: 4	<b>CAN-H</b>	T3: 40
<b>GPT</b>	T2: 40, T1: G2		

## Connection version 2

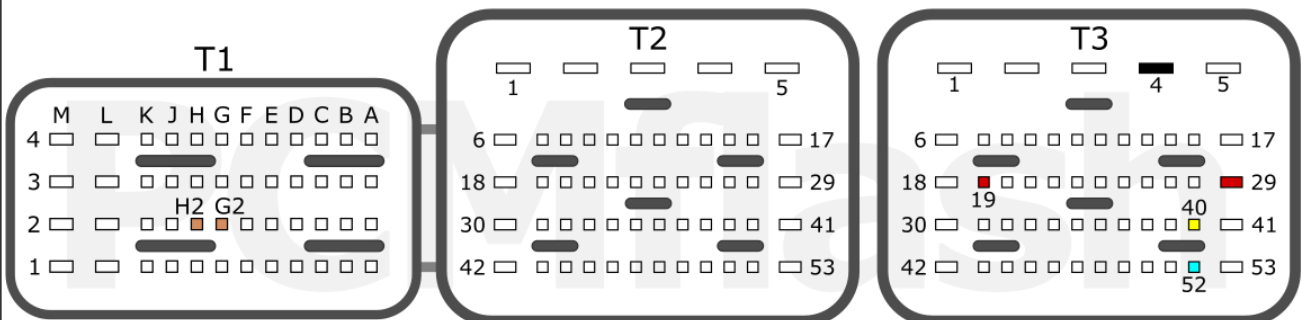

<b>+12V</b>	T3: 19, 29	<b>CAN-L</b>	T3: 52
<b>GND</b>	T3: 4	<b>CAN-H</b>	T3: 40
<b>GPT</b>	T1: H2; T1:G2		

PSA

pcmflash.ru

v.4

2025.03.11

# PCMflash

Engine Control Unit

## MED17.4.4 TC1793

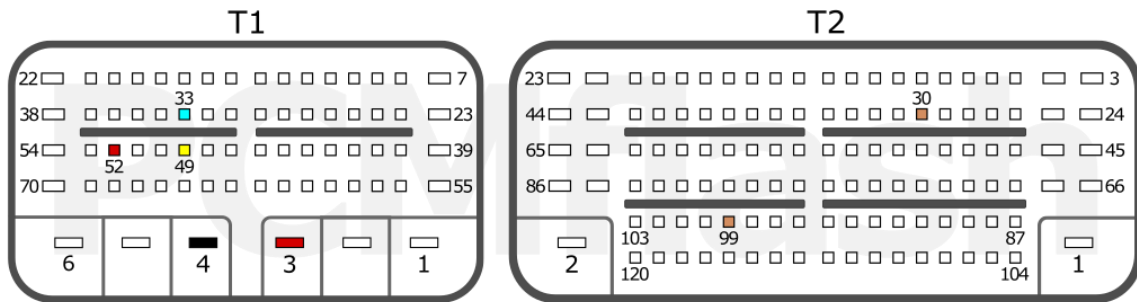

<b>+12V</b>	T1: 52, 3	<b>CAN-L</b>	T1: 33
<b>GND</b>	T1: 4	<b>CAN-H</b>	T1: 49
<b>GPT</b>	T2: 99, 30		

CITROEN

pcmflash.ru

v.1

2021-10-06

# PCMflash

Engine Control Unit

## MEVD17.4.4 TC1793

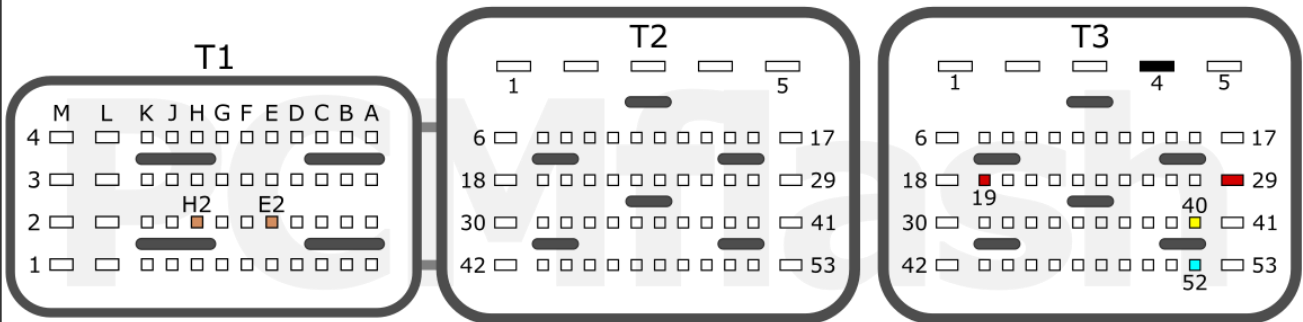

<b>+12V</b>	T3: 19, 29	<b>CAN-L</b>	T3: 52
<b>GND</b>	T3: 4	<b>CAN-H</b>	T3: 40
<b>GPT</b>	T1: H2, E2		

PSA

pcmflash.ru

v.1

2021-10-12

# PCMflash

Engine Control Unit

ME(V)17.4.5 TC1796

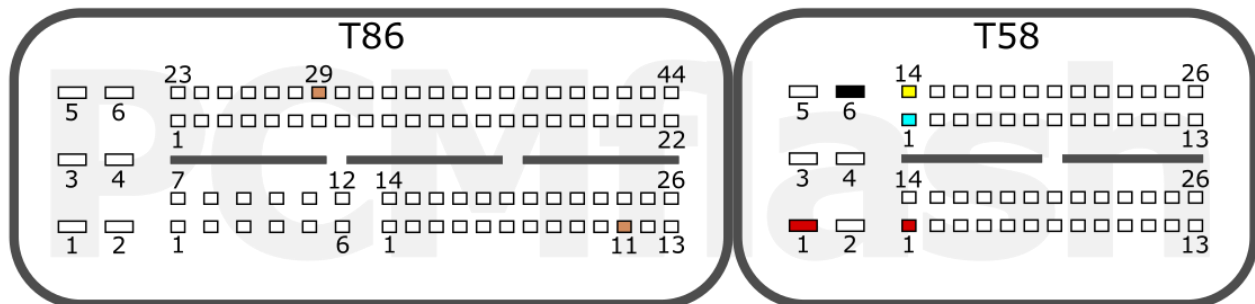

<b>+12V</b>	T58: 1, 1	<b>CAN-L</b>	T58: 1
<b>GND</b>	T58: 6	<b>CAN-H</b>	T58: 14
<b>GPT</b>	T86: 11, 29		

BMW

pcmflash.ru

v.2

2021-12-14

# PCMflash

Engine Control Unit

## MEV17.4.6 TC1796

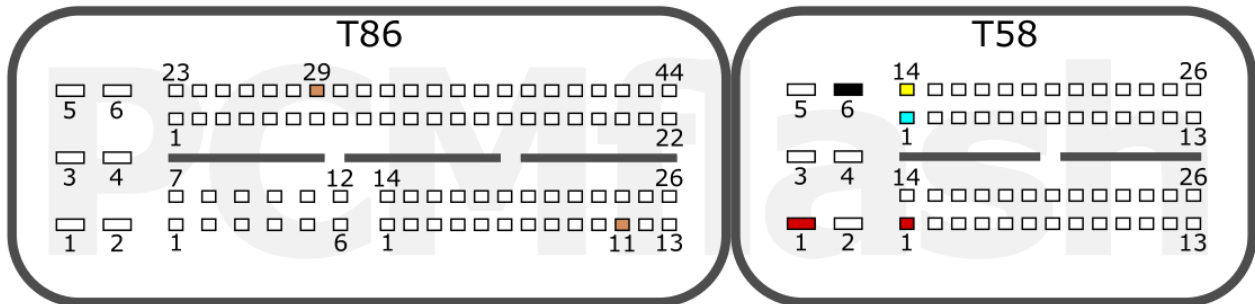

<b>+12V</b>	T58: 1, 1	<b>CAN-L</b>	T58: 1
<b>GND</b>	T58: 6	<b>CAN-H</b>	T58: 14
<b>GPT</b>	T86: 11, 29		

BMW

pcmflash.ru

v.2

2021-12-14



# PCMflash

Engine Control Unit

## ME17.5 TC1766

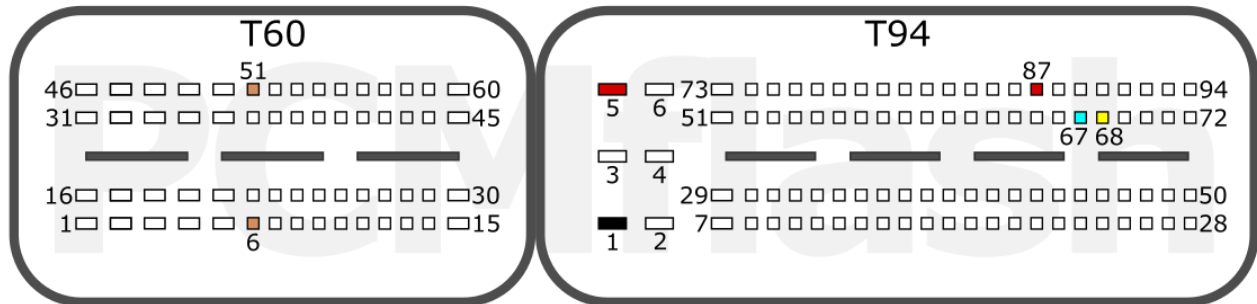

<b>+12V</b>	T94: 5, 87	<b>CAN-L</b>	T94: 67
<b>GND</b>	T94: 1	<b>CAN-H</b>	T94: 68
<b>GPT</b>	T60: 6, 51		

VAG

pcmflash.ru

v.1

2021-12-06

# PCMflash

Engine Control Unit

## MED17.5 TC1766

### SKODA

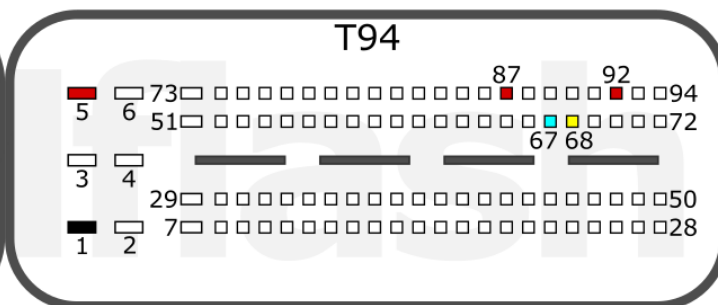
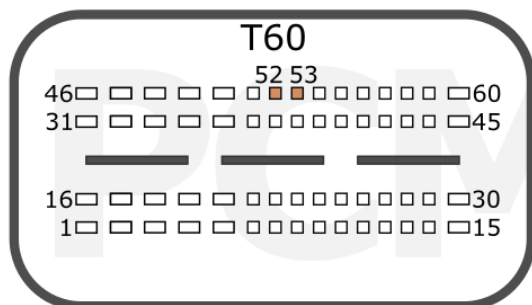

<b>+12V</b>	T94: 5, 87, 92	<b>CAN-L</b>	T94: 67
<b>GND</b>	T94: 1	<b>CAN-H</b>	T94: 68
<b>GPT</b>	T60: 52, 53		

### VAG

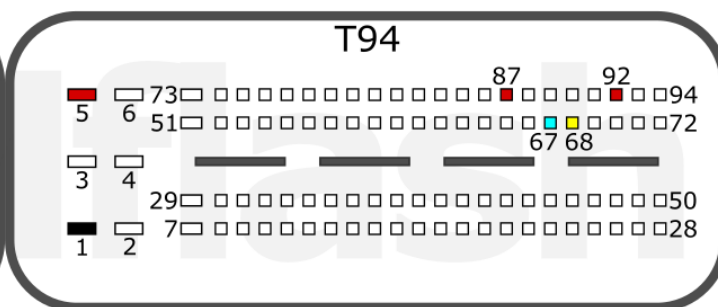
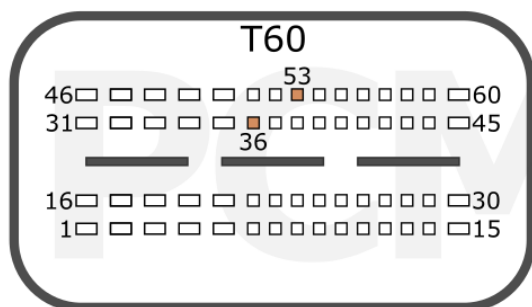

<b>+12V</b>	T94: 5, 87, 92	<b>CAN-L</b>	T94: 67
<b>GND</b>	T94: 1	<b>CAN-H</b>	T94: 68
<b>GPT</b>	T60: 53, 36		

SKODA

VAG

pcmflash.ru

v.2

2022-03-31

# PCMflash

Engine Control Unit

## MED17.5.1 TC1796

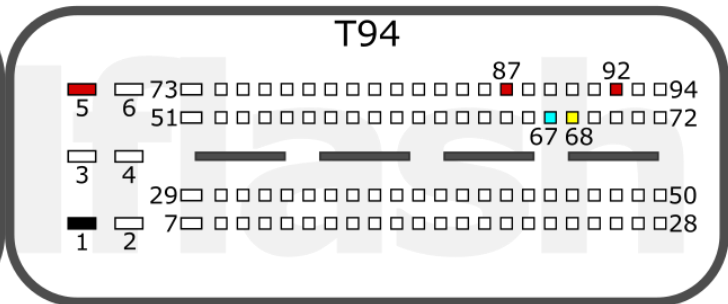
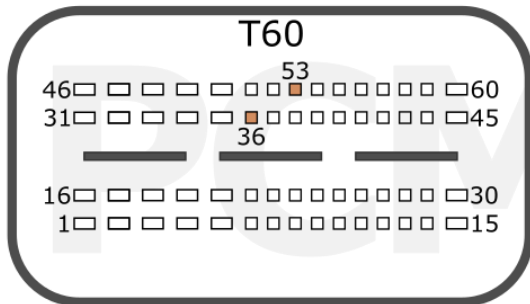

<b>+12V</b>	T94: 5, 87, 92	<b>CAN-L</b>	T94: 67
<b>GND</b>	T94: 1	<b>CAN-H</b>	T94: 68
<b>GPT</b>	T60: 36, 53		

VAG

pcmflash.ru

v.1

2021-10-11

# PCMflash

Engine Control Unit

## MED17.5.2 TC1767

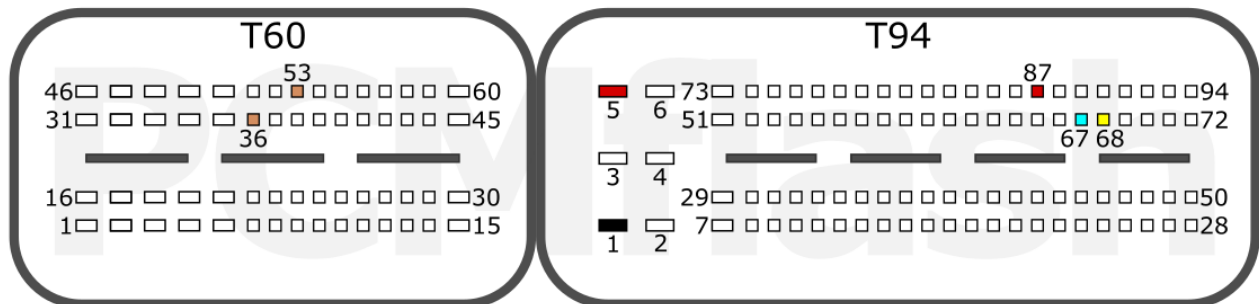

<b>+12V</b>	T94: 5, 87	<b>CAN-L</b>	T94: 67
<b>GND</b>	T94: 1	<b>CAN-H</b>	T94: 68
<b>GPT</b>	T60: 53, 36		

VAG

pcmflash.ru

v.1

2021-09-02

# PCMflash

Engine Control Unit

## MED17.5.5 TC1766

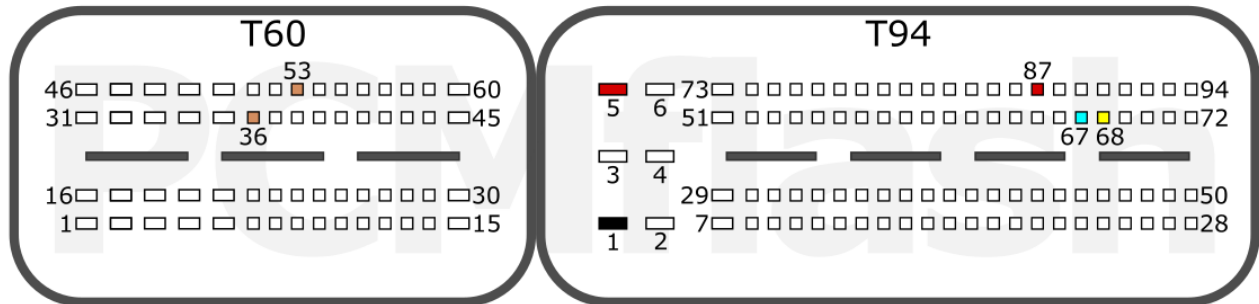

<b>+12V</b>	T94: 5, 87	<b>CAN-L</b>	T94: 67
<b>GND</b>	T94: 1	<b>CAN-H</b>	T94: 68
<b>GPT</b>	T60: 53, 36		

VAG

pcmflash.ru

v.1

2021-10-07

# PCMflash

Engine Control Unit

## ME17.5.6 TC1767

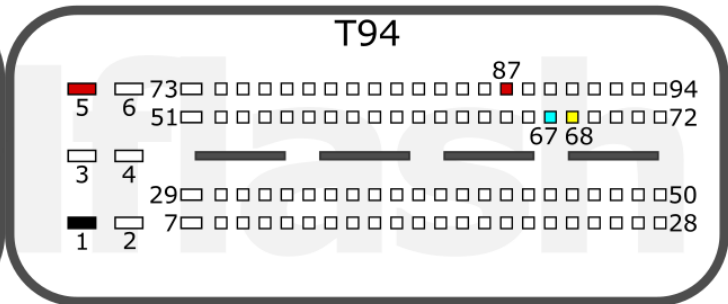
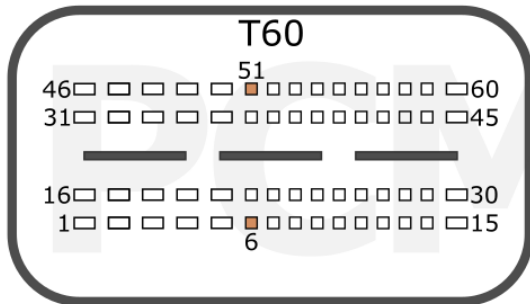

<b>+12V</b>	T94: 5, 87	<b>CAN-L</b>	T94: 67
<b>GND</b>	T94: 1	<b>CAN-H</b>	T94: 68
<b>GPT</b>	T60: 6, 51		

VAG

pcmflash.ru

v.2

2023-05-21



# PCMflash

Engine Control Unit

## MED17.5.21 TC1782

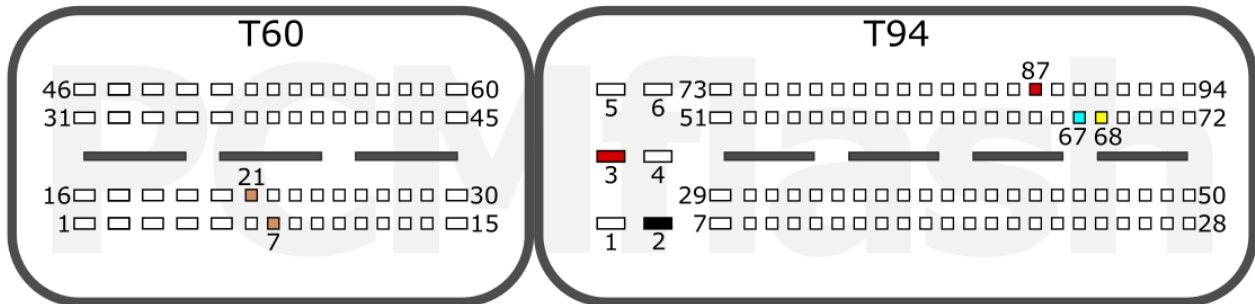

<b>+12V</b>	T94: 3, 87	<b>CAN-L</b>	T94: 67
<b>GND</b>	T94: 2	<b>CAN-H</b>	T94: 68
<b>GPT</b>	T60: 21, 7		

VAG

pcmflash.ru

v.1

2021-09-30



# PCMflash

Engine Control Unit

## ME17.5.22 TC1724

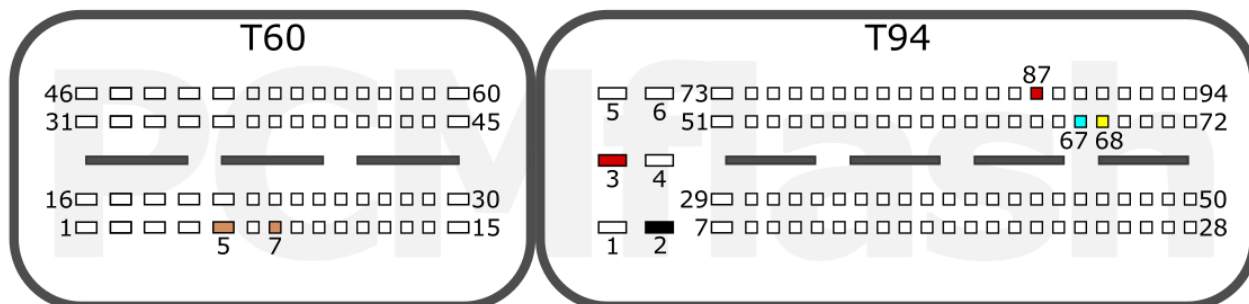

<b>+12V</b>	T94: 3, 87	<b>CAN-L</b>	T94: 67
<b>GND</b>	T94: 2	<b>CAN-H</b>	T94: 68
<b>GPT</b>	T60: 5, 7		

VAG

pcmflash.ru

v.1

2024-07-12

# PCMflash

Engine Control Unit

## MED17.5.25 TC1782

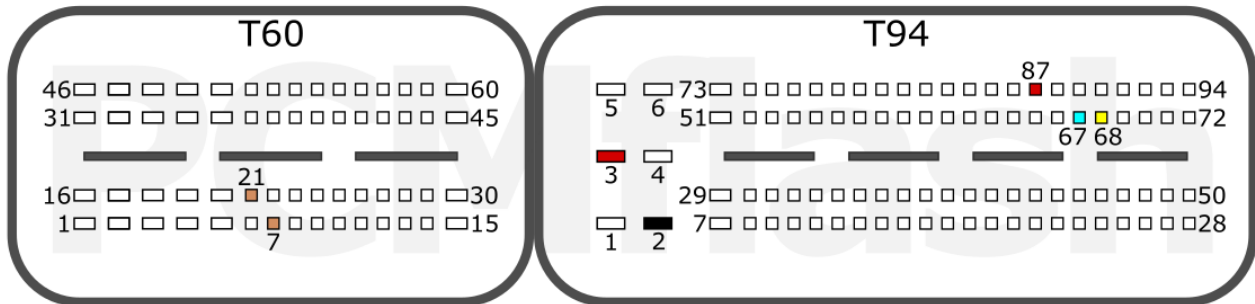

<b>+12V</b>	T94: 3, 87	<b>CAN-L</b>	T94: 67
<b>GND</b>	T94: 2	<b>CAN-H</b>	T94: 68
<b>GPT</b>	T60: 21, 7		

SKODA

pcmflash.ru

v.1

2021-09-26

# PCMflash

Engine Control Unit

## ME17.5.26 TC1724

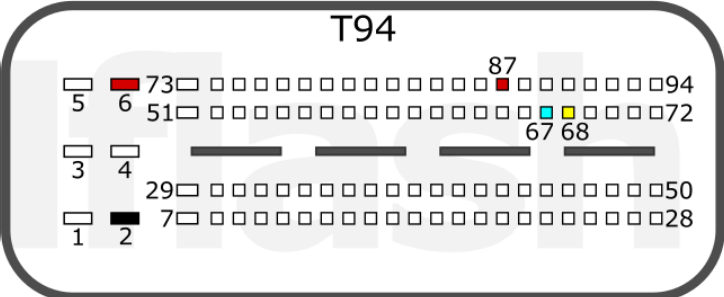
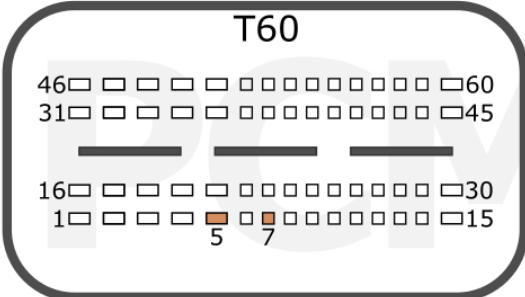

<b>+12V</b>	T94: 6, 87	<b>CAN-L</b>	T94: 67
<b>GND</b>	T94: 2	<b>CAN-H</b>	T94: 68
<b>GPT</b>	T60: 7, 5		

VAG

pcmflash.ru

v.1

2021-08-27



# PCMflash

Engine Control Unit

## MED17.7.1 TC1797

### Connection version 1

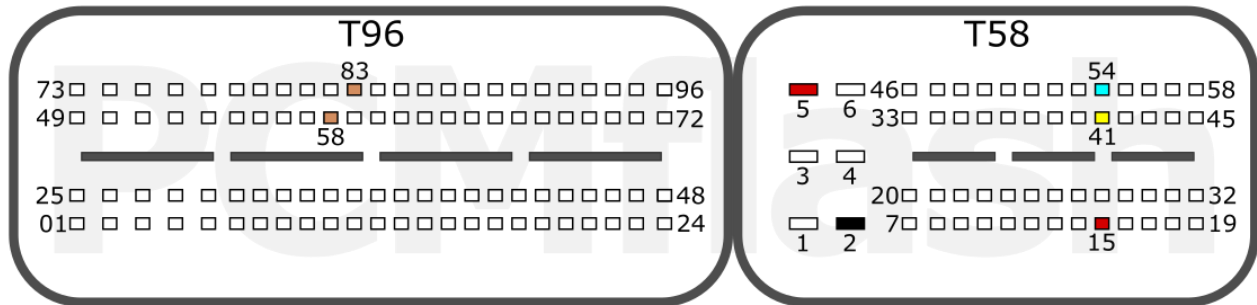

<b>+12V</b>	T58: 5, 15	<b>CAN-L</b>	T58: 54
<b>GND</b>	T58: 2	<b>CAN-H</b>	T58: 41
<b>GPT</b>	T96: 83, 58		

### Connection version 2

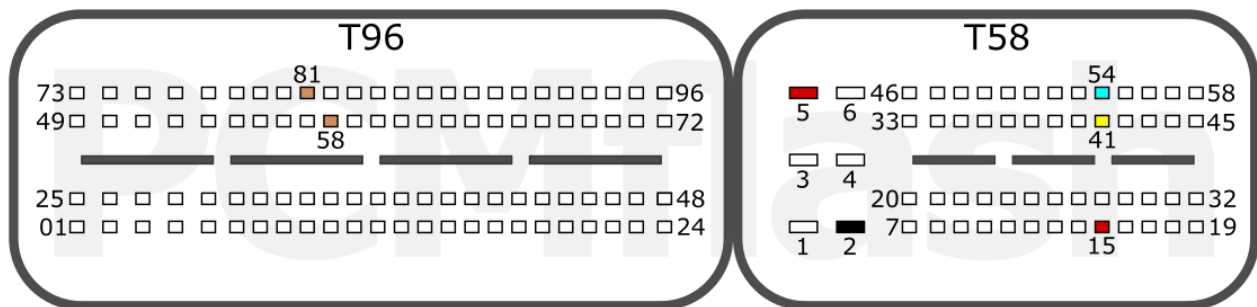

<b>+12V</b>	T58: 5, 15	<b>CAN-L</b>	T58: 54
<b>GND</b>	T58: 2	<b>CAN-H</b>	T58: 41
<b>GPT</b>	T96: 81, 58		

MB

pcmflash.ru

v.1

2021-11-01



# PCMflash

Engine Control Unit

## MED17.7.3 TC1797

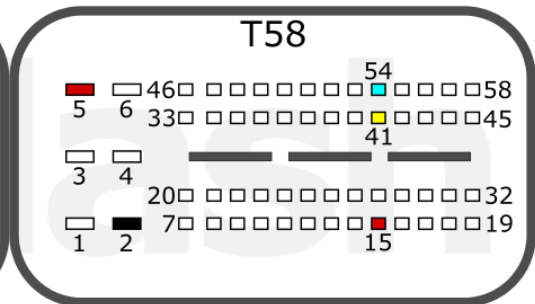
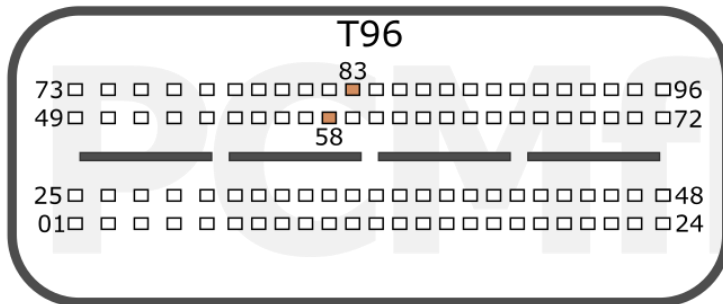

<b>+12V</b>	T58: 5, 15	<b>CAN-L</b>	T58: 54
<b>GND</b>	T58: 2	<b>CAN-H</b>	T58: 41
<b>GPT</b>	T96: 83, 58		

MB

pcmflash.ru

v.1

2021-09-08

# PCMflash

Engine Control Unit

## MED17.7.3.1 TC1797

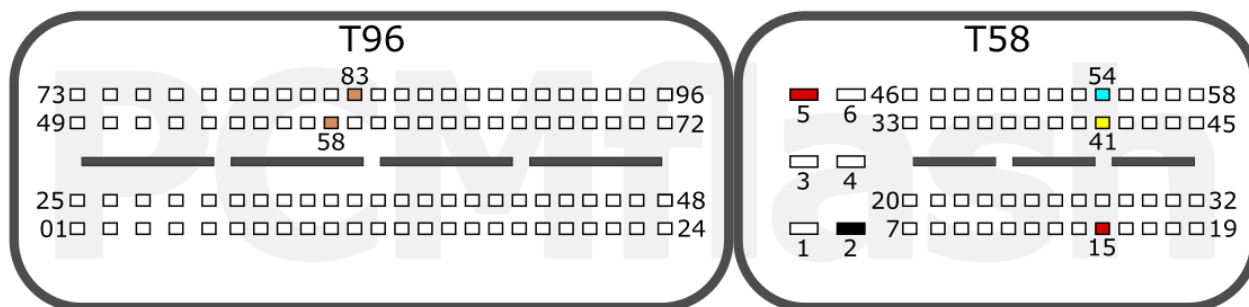

<b>+12V</b>	T58: 5, 15	<b>CAN-L</b>	T58: 54
<b>GND</b>	T58: 2	<b>CAN-H</b>	T58: 41
<b>GPT</b>	T96: 83, 58		

MB

pcmflash.ru

v.1

2021-11-01



# PCMflash

Engine Control Unit

## MED17.7.5 TC1793

T105

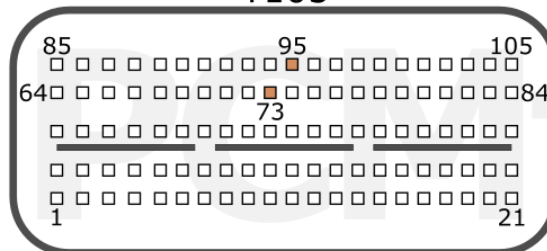

T91

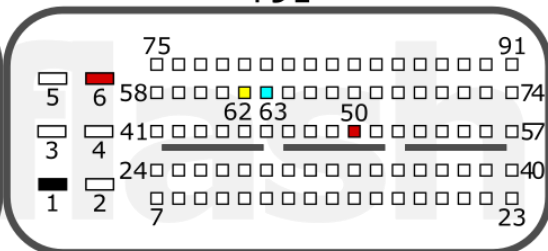

<b>+12V</b>	T91: 6, 50	<b>CAN-L</b>	T91: 63
<b>GND</b>	T91: 1	<b>CAN-H</b>	T91: 62
<b>GPT</b>	T105: 73, 95		

MB

pcmflash.ru

v.1

2021-10-06

# PCMflash

Engine Control Unit

## MED17.7.7 TC1793

### Connection version 1



<b>+12V</b>	T58: 3, 15, 16	<b>CAN-L</b>	T58: 54
<b>GND</b>	T58: 4	<b>CAN-H</b>	T58: 41
<b>GPT</b>	T96: 58, 82		

### Connection version 2

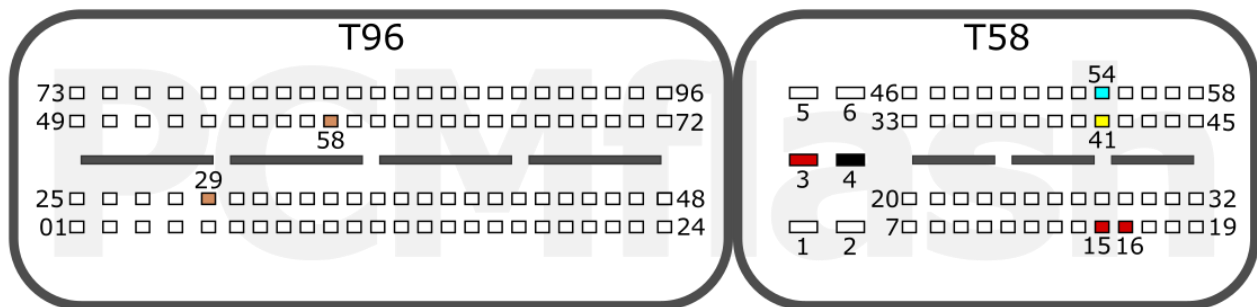

<b>+12V</b>	T58: 3, 15, 16	<b>CAN-L</b>	T58: 54
<b>GND</b>	T58: 4	<b>CAN-H</b>	T58: 41
<b>GPT</b>	T96: 29, 58		

MB

pcmflash.ru

v.1

2021-09-10



# PCMflash

Engine Control Unit

## MEVD17.8.4 TC1797

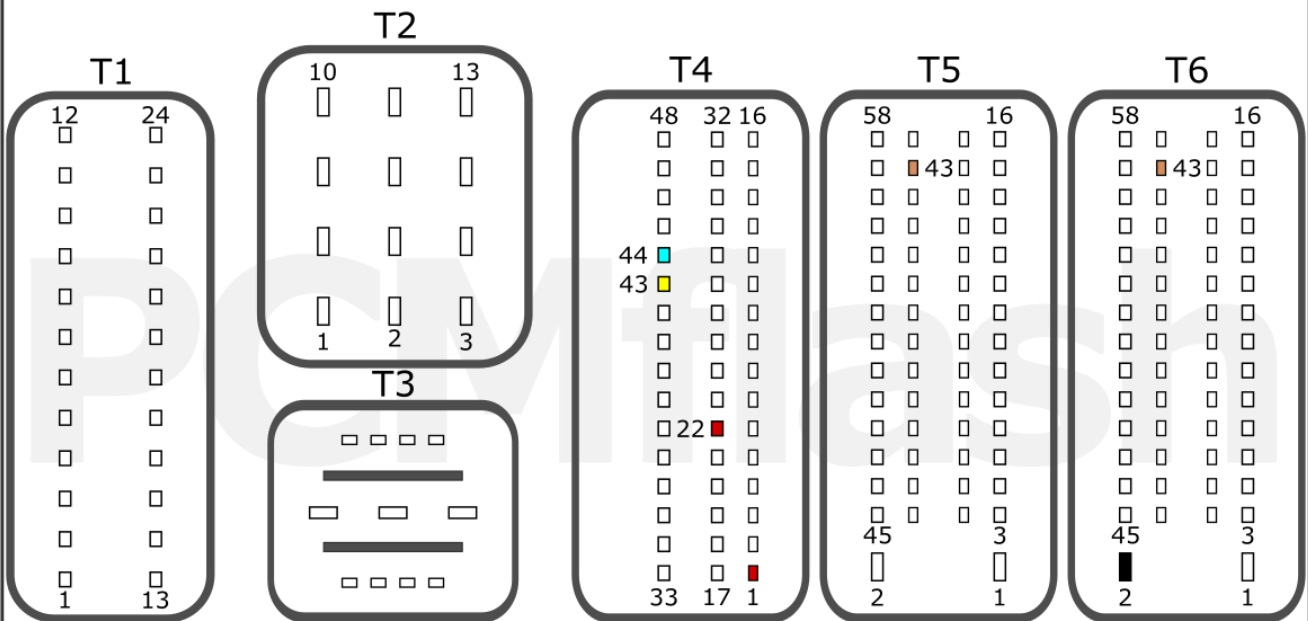

<b>+12V</b>	T4: 1, 22	<b>CAN-L</b>	T4: 44
<b>GND</b>	T6: 2	<b>CAN-H</b>	T4: 43
<b>GPT</b>	T5: 43, T6: 43		

BMW

pcmflash.ru

v.1

2021-11-01

# PCMflash

Engine Control Unit

## ME17.8.5 TC1762

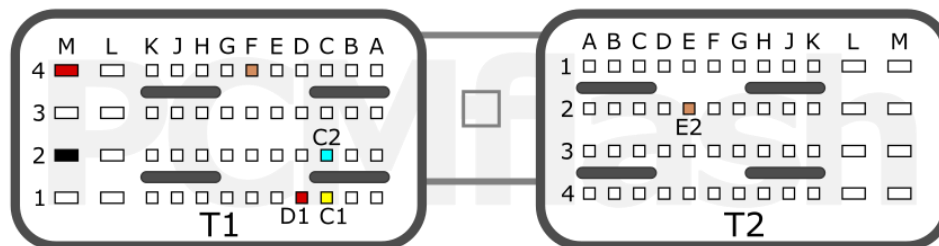

<b>+12V</b>	T1: M4, D1	<b>CAN-L</b>	T1: C2
<b>GND</b>	T1: M2	<b>CAN-H</b>	T1: C1
<b>GPT</b>	T1: F4, T2:E2		

ROTAX

pcmflash.ru

v.1

2021-09-28

# PCMflash

Engine Control Unit

## M17.8.7 TC1762

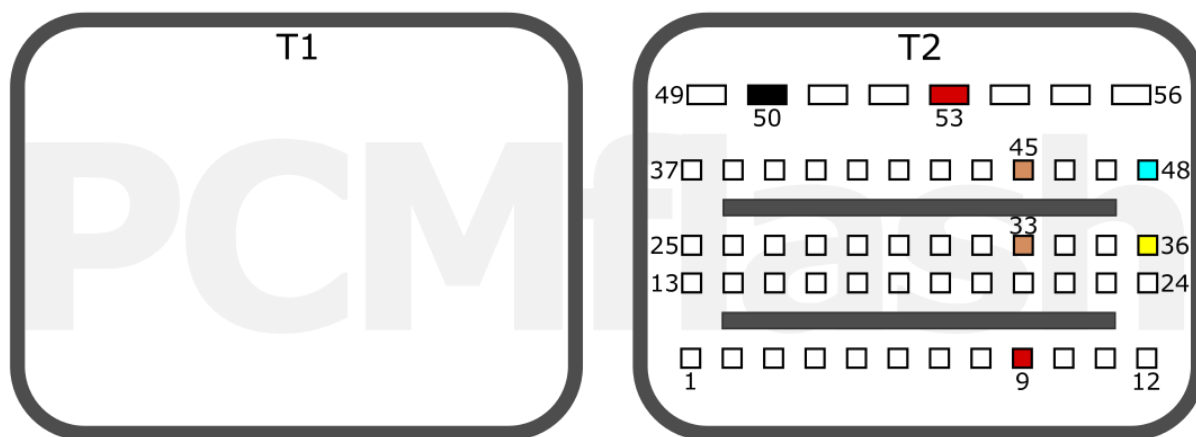

<b>+12V</b>	T2: 53, 9	<b>CAN-L</b>	T2: 48
<b>GND</b>	T2: 50	<b>CAN-H</b>	T2: 36
<b>GPT</b>	T2: 45, 33		

POLARIS ATV

pcmflash.ru

v.1

2021-12-09

# PCMflash

Engine Control Unit

ME17.8.8/ME17.8.8.1/ME17U6 TC1728/TC1782

## Connection version 1



<b>+12V</b>	T1: 20, 35	<b>CAN-L</b>	T1: 17
<b>GND</b>	T1: 64	<b>CAN-H</b>	T1: 1
<b>GPT*</b>	T2: 93, 96		

\*Select "Use other GPT output pins" in the pcmflash settings or set GPT to EXT in case powerbox for PCMflash is used /  
 При использовании powerbox for PCMflash выбрать режим GPT EXT или использовать альтернативные пины

## Connection version 2



<b>+12V</b>	T1: 20, 35	<b>CAN-L</b>	T1: 3
<b>GND</b>	T1: 64	<b>CAN-H</b>	T1: 4
<b>GPT*</b>	T2: 93, 96		

\*Select "Use other GPT output pins" in the pcmflash settings or set GPT to EXT in case powerbox for PCMflash is used /  
 При использовании powerbox for PCMflash выбрать режим GPT EXT или использовать альтернативные пины

CHINA

pcmflash.ru

v.1

2023-07-01

# PCMflash

Engine Control Unit

MED17.8.10 TC1728/TC1782

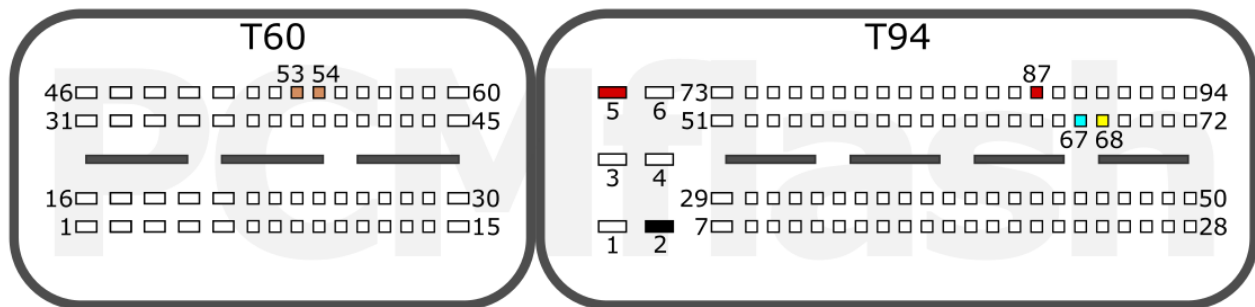

<b>+12V</b>	T94: 5, 87	<b>CAN-L</b>	T94: 67
<b>GND</b>	T94: 2	<b>CAN-H</b>	T94: 68
<b>GPT</b>	T60: 53, 54		

CHINA

pcmflash.ru

v.2

2023-07-30





# PCMflash

Engine Control Unit

## MED17.8.31 TC1797

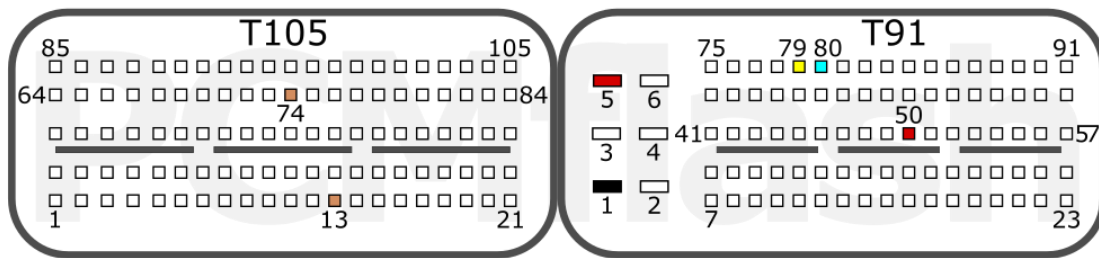

<b>+12V</b>	T91: 5, 50	<b>CAN-L</b>	T91: 80
<b>GND</b>	T91: 1	<b>CAN-H</b>	T91: 79
<b>GPT</b>	T105: 13, 74		

JLR

pcmflash.ru

v.1

2021-09-11

# PCMflash

Engine Control Unit

ME17.8.32 TC1797

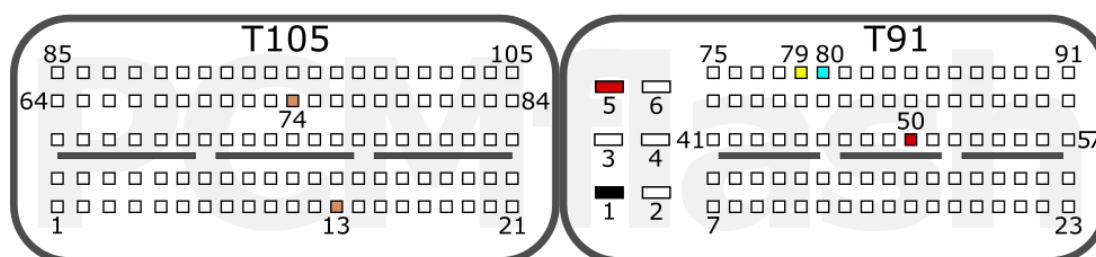

<b>+12V</b>	T91: 5, 50	<b>CAN-L</b>	T91: 80
<b>GND</b>	T91: 1	<b>CAN-H</b>	T91: 79
<b>GPT</b>	T105: 74, 13		

MCLAREN

pcmflash.ru

v.1

2021-10-14

# PCMflash

Engine Control Unit

## MED17.8.32 TC1793

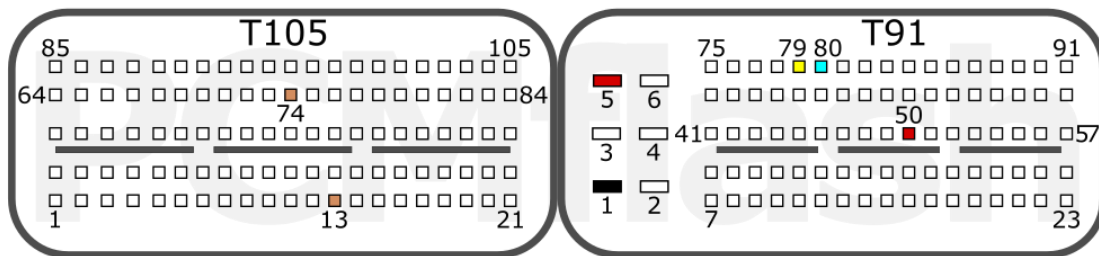

<b>+12V</b>	T91: 5, 50	<b>CAN-L</b>	T91: 80
<b>GND</b>	T91: 1	<b>CAN-H</b>	T91: 79
<b>GPT</b>	T105: 13, 74		

JLR

pcmflash.ru

v.1

2021-10-12

# PCMflash

Engine Control Unit

MED17.8.34/17.8.35 TC1793

## Connection version 1

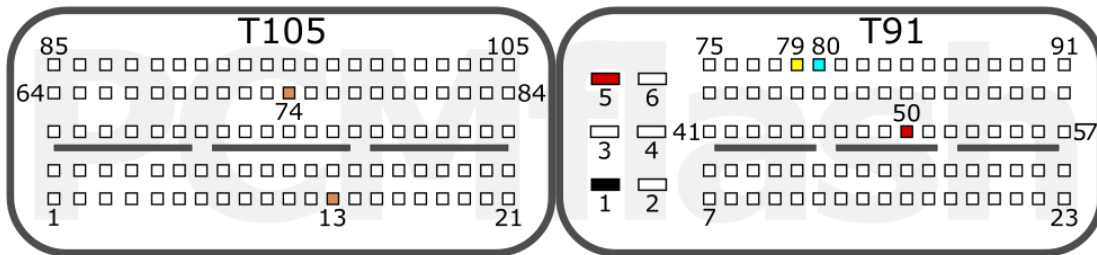

<b>+12V</b>	T91: 5, 50	<b>CAN-L</b>	T91: 80
<b>GND</b>	T91: 1	<b>CAN-H</b>	T91: 79
<b>GPT</b>	T105: 13, 74		

AURUS

HONGQI

pcmflash.ru

v.2

2024-12-30

# PCMflash

Engine Control Unit

## MEDC17.9 TC1793

T105

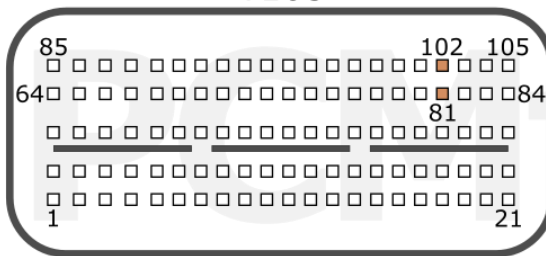

T91

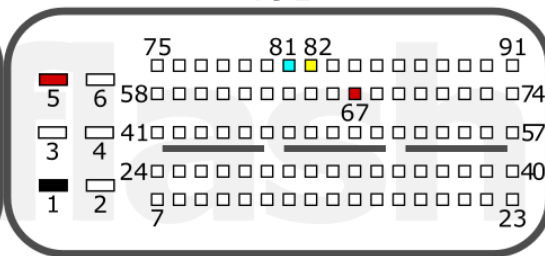

<b>+12V</b>	T91: 5, 67	<b>CAN-L</b>	T91: 81
<b>GND</b>	T91: 1	<b>CAN-H</b>	T91: 82
<b>GPT</b>	T105: 81, 102		

JLR

pcmflash.ru

v.1

2021-10-09



# PCMflash

Engine Control Unit

MEG17.9.2 TC1767

T105

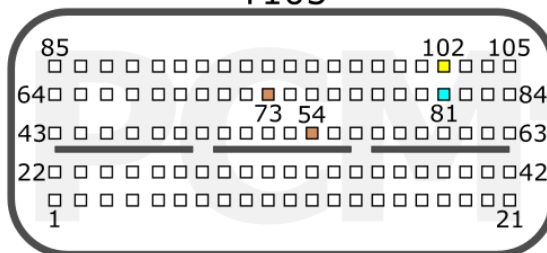

T91

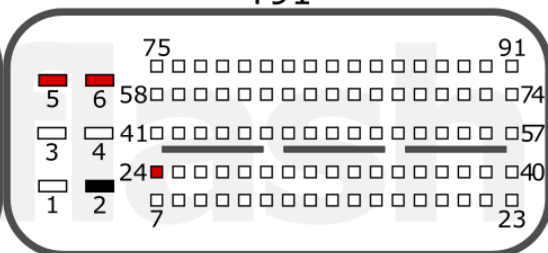

<b>+12V</b>	T91: 5, 6, 24	<b>CAN-L</b>	T105: 81
<b>GND</b>	T91: 2	<b>CAN-H</b>	T105: 102
<b>GPT</b>	T105: 54, 73		

K/H

pcmflash.ru

v.1

2022-03-04



# PCMflash

Engine Control Unit

## MED17.9.3 TC1793

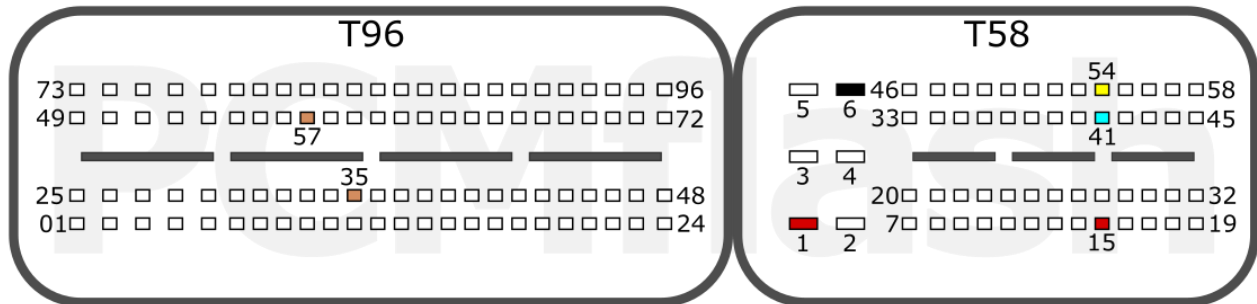

<b>+12V</b>	T58: 1, 15	<b>CAN-L</b>	T58: 41
<b>GND</b>	T58: 6	<b>CAN-H</b>	T58: 54
<b>GPT</b>	T96: 35, 57		

HONDA

pcmflash.ru

v.1

2021-10-31

# PCMflash

Engine Control Unit

## ME17.9.5 TC1762

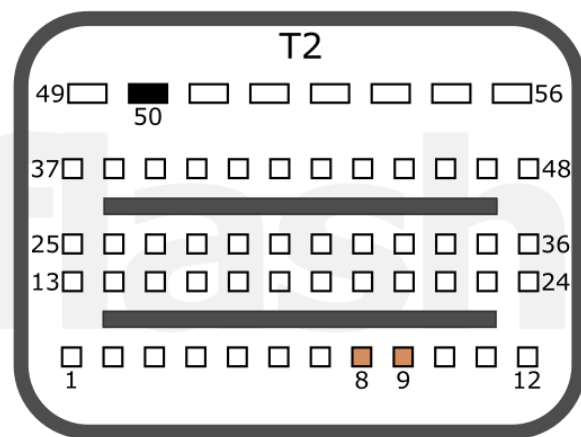
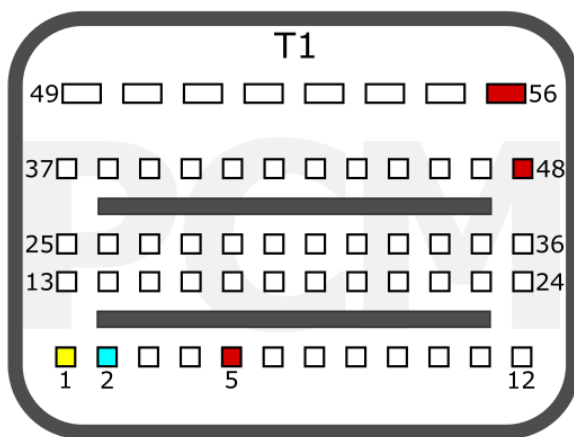

<b>+12V</b>	T1: 56, 48, 5	<b>CAN-L</b>	T1: 2
<b>GND</b>	T2: 50	<b>CAN-H</b>	T1: 1
<b>GPT</b>	T2: 9, 8		

SUZUKI

pcmflash.ru

v.1

2024-08-13



# PCMflash

Engine Control Unit

## ME17.9.7 TC1762

### UAZ

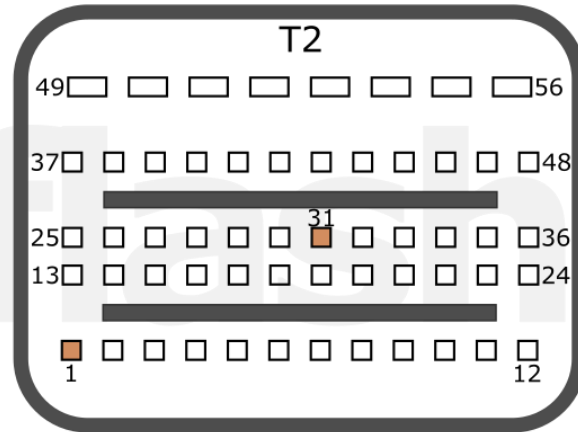
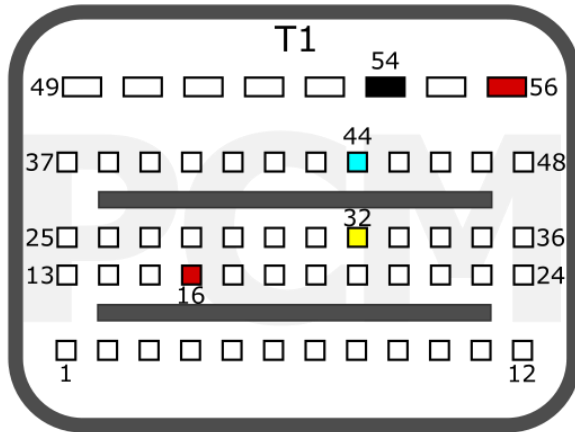

<b>+12V</b>	T1: 56, 16	<b>CAN-L</b>	T1: 44
<b>GND</b>	T1: 54	<b>CAN-H</b>	T1: 32
<b>GPT</b>	T2: 1, 31		

### VAZ

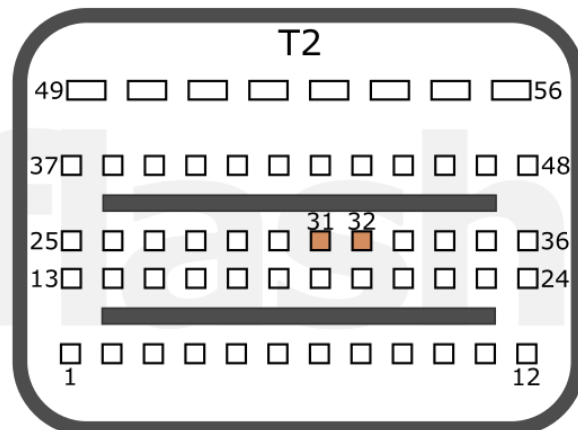
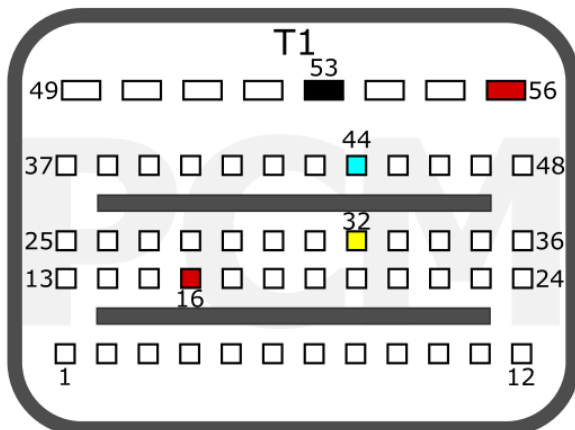

<b>+12V</b>	T1: 56, 16	<b>CAN-L</b>	T1: 44
<b>GND</b>	T1: 53	<b>CAN-H</b>	T1: 32
<b>GPT</b>	T2: 32, 31		

VAZ

UAZ

pcmflash.ru

v.1

2021-09-03



# PCMflash

Engine Control Unit

## ME(D)17.9.8 TC1767

### Connection version 1

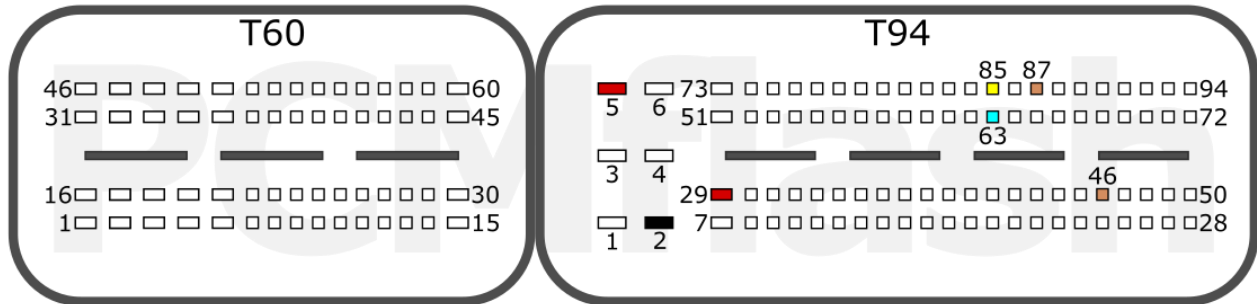

<b>+12V</b>	T94: 5, 29	<b>CAN-L</b>	T94: 63
<b>GND</b>	T94: 2	<b>CAN-H</b>	T94: 85
<b>GPT</b>	T94: 46, 87		

### Connection version 2

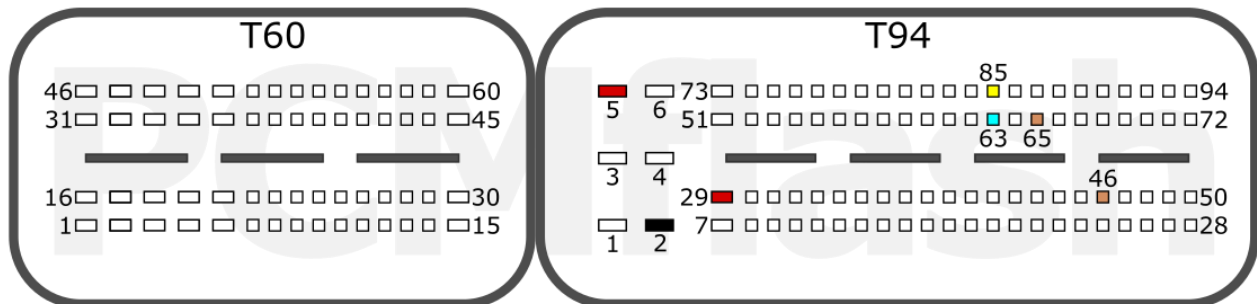

<b>+12V</b>	T94: 5, 29	<b>CAN-L</b>	T94: 63
<b>GND</b>	T94: 2	<b>CAN-H</b>	T94: 85
<b>GPT</b>	T94: 46, 65		

### Connection version 3

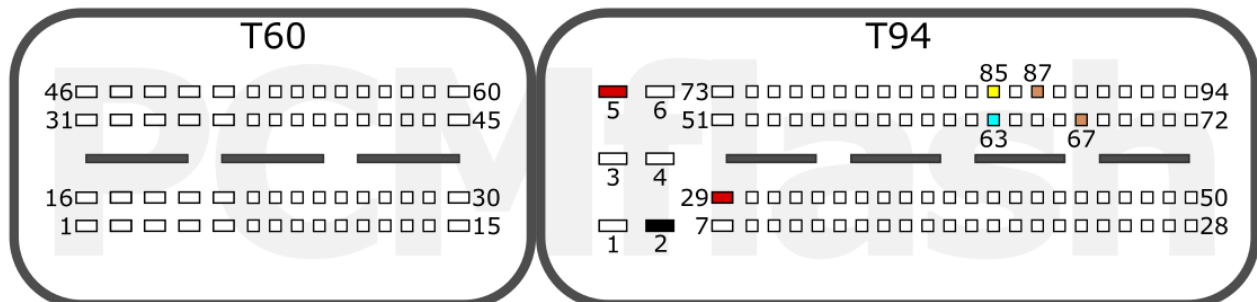

<b>+12V</b>	T94: 5, 29	<b>CAN-L</b>	T94: 63
<b>GND</b>	T94: 2	<b>CAN-H</b>	T94: 85
<b>GPT</b>	T94: 67, 87		

K/H

pcmflash.ru

v.2

2022-06-14

# PCMflash

Engine Control Unit

MEG17.9.8 TC1767

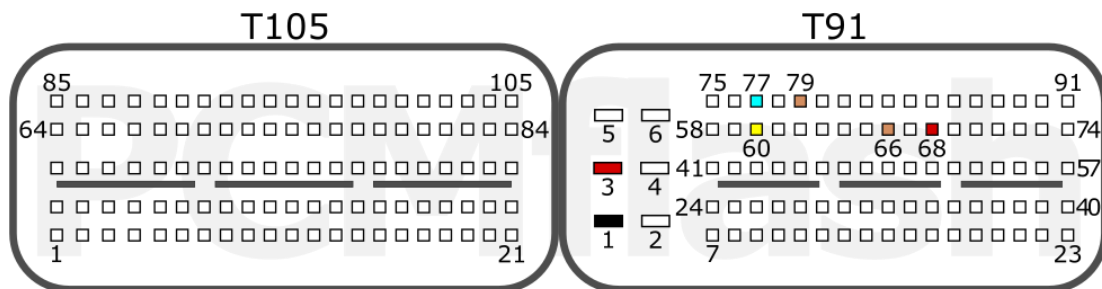

<b>+12V</b>	T91: 3, 68	<b>CAN-L</b>	T91: 77
<b>GND</b>	T91: 1	<b>CAN-H</b>	T91: 60
<b>GPT</b>	T91: 66, 79		

K/H

pcmflash.ru

v.1

2021-10-15

# PCMflash

Engine Control Unit

## MEDG17.9.8 TC1767

### Connection version 1

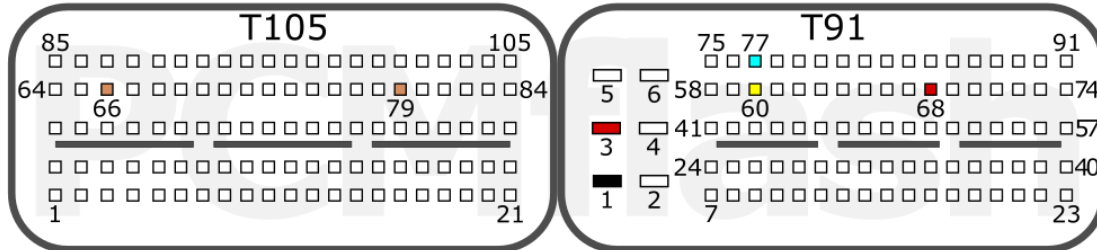

<b>+12V</b>	T91: 3, 68	<b>CAN-L</b>	T91: 77
<b>GND</b>	T91: 1	<b>CAN-H</b>	T91: 60
<b>GPT</b>	T105: 66, 79		

### Connection version 2

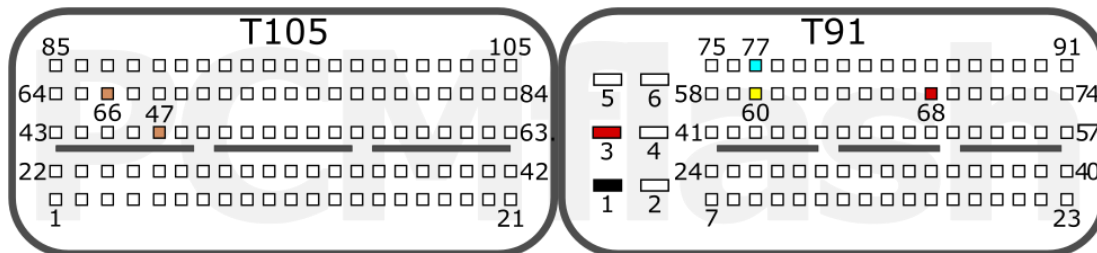

<b>+12V</b>	T91: 3, 68	<b>CAN-L</b>	T91: 77
<b>GND</b>	T91: 1	<b>CAN-H</b>	T91: 60
<b>GPT</b>	T105: 66, 47		

### Connection version 3

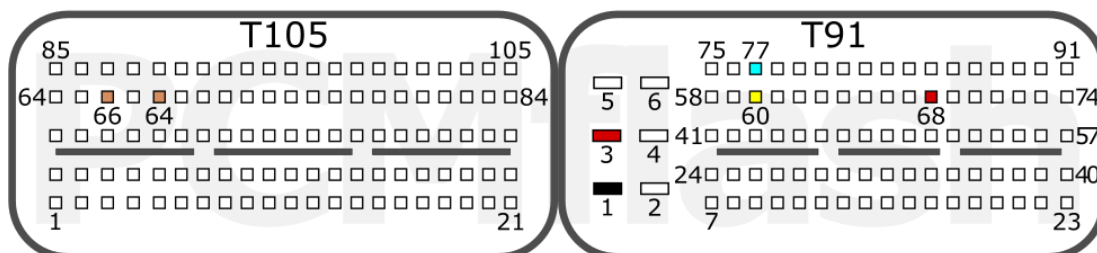

<b>+12V</b>	T91: 3, 68	<b>CAN-L</b>	T91: 77
<b>GND</b>	T91: 1	<b>CAN-H</b>	T91: 60
<b>GPT</b>	T105: 66, 64		

K/H

pcmflash.ru

v.2

2022-04-17



# PCMflash

Engine Control Unit

## MED17.9.9 TC1793

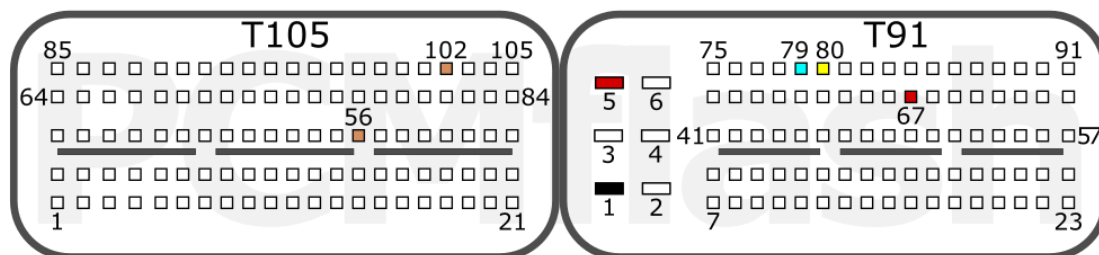

<b>+12V</b>	T91: 5, 67	<b>CAN-L</b>	T91: 79
<b>GND</b>	T91: 1	<b>CAN-H</b>	T91: 80
<b>GPT</b>	T105: 56, 102		

JLR

pcmflash.ru

v.1

2021-09-11

# PCMflash

Engine Control Unit

## M17.9.11 TC1762

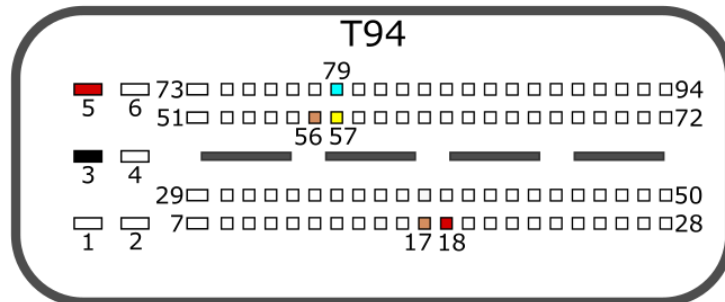

<b>+12V</b>	T94: 5, 18	<b>CAN-L</b>	T94: 79
<b>GND</b>	T94: 3	<b>CAN-H</b>	T94: 57
<b>GPT</b>	T94: 17, 56		

K/H

pcmflash.ru

v.1

2024-06-02

# PCMflash

Engine Control Unit

## ME17.9.11 TC1762

### Connection version 1

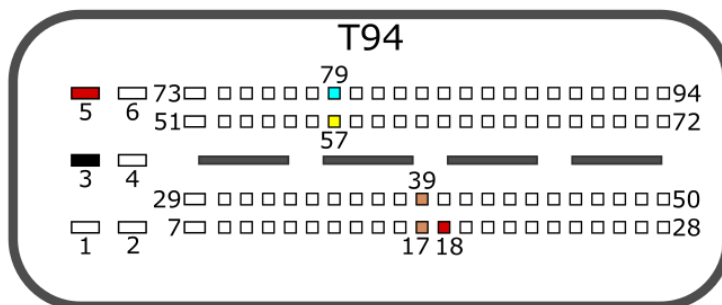

<b>+12V</b>	T94: 5, 18	<b>CAN-L</b>	T94: 79
<b>GND</b>	T94: 3	<b>CAN-H</b>	T94: 57
<b>GPT</b>	T94: 17, 39		

### Connection version 2

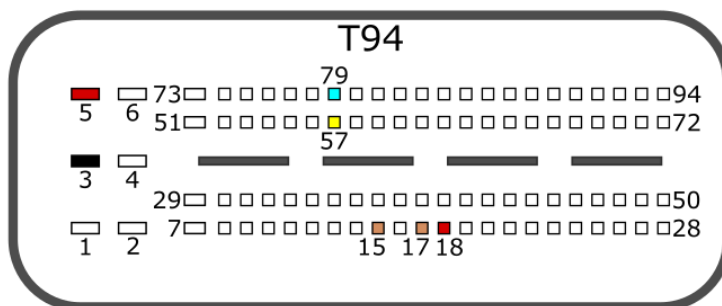

<b>+12V</b>	T94: 5, 18	<b>CAN-L</b>	T94: 79
<b>GND</b>	T94: 3	<b>CAN-H</b>	T94: 57
<b>GPT</b>	T94: 17, 15		

K/H

# PCMflash

Engine Control Unit

MEG17.9.12/17.9.13 TC1762

## Connection version 1

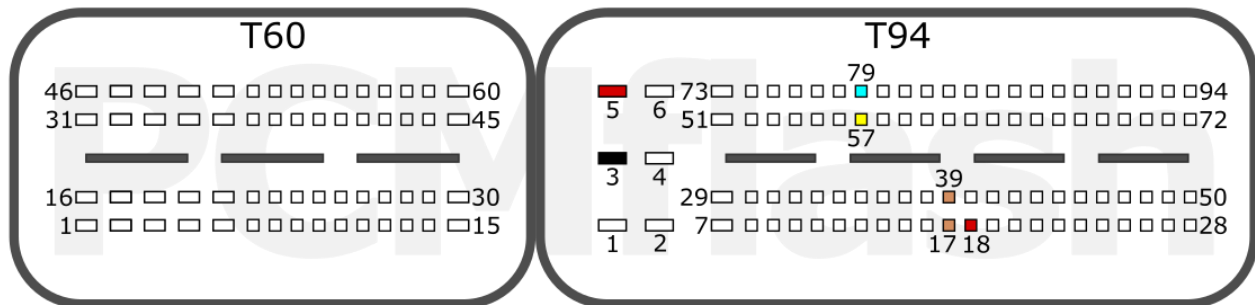

<b>+12V</b>	T94: 5, 18	<b>CAN-L</b>	T94: 79
<b>GND</b>	T94: 3	<b>CAN-H</b>	T94: 57
<b>GPT</b>	T94: 17, 39		

## Connection version 2

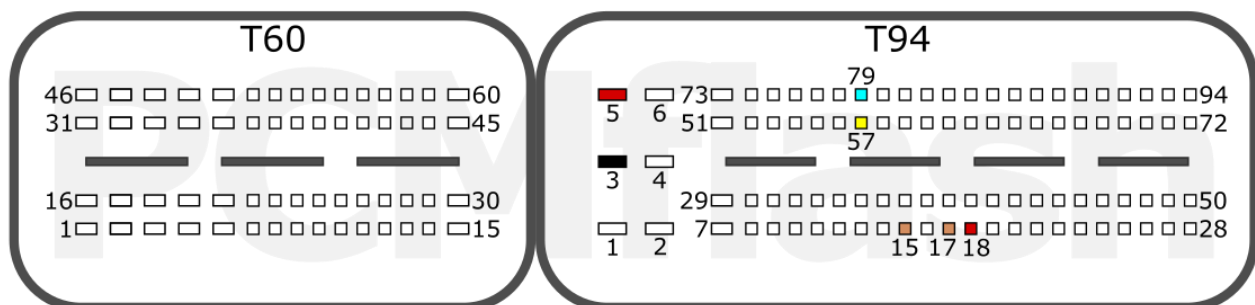

<b>+12V</b>	T94: 5, 18	<b>CAN-L</b>	T94: 79
<b>GND</b>	T94: 3	<b>CAN-H</b>	T94: 57
<b>GPT</b>	T94: 17, 15		

K/H

pcmflash.ru

v.2

2023-12-08

# PCMflash

Engine Control Unit

## ME17.9.20 TC1782

### BRABUS, SMART

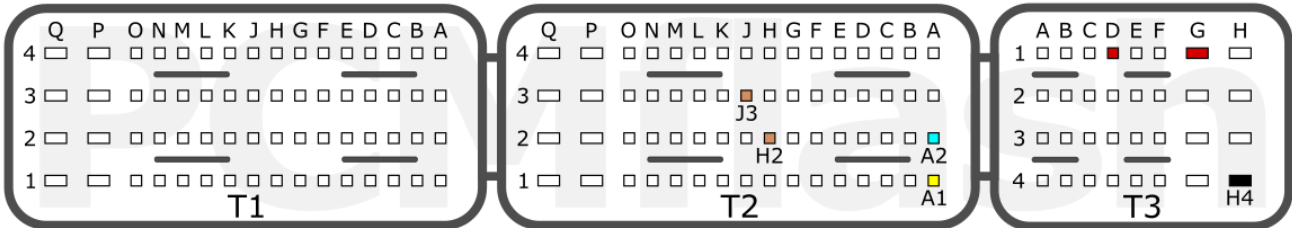

<b>+12V</b>	T3: D1, G1	<b>CAN-L</b>	T2: A2
<b>GND</b>	T3: H4	<b>CAN-H</b>	T2: A1
<b>GPT</b>	T2: H2, J3		

### RENAULT

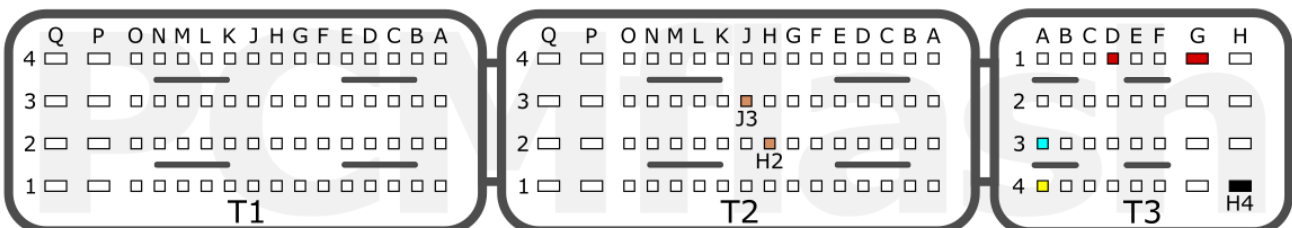

<b>+12V</b>	T3: D1, G1	<b>CAN-L</b>	T3: A3
<b>GND</b>	T3: H4	<b>CAN-H</b>	T3: A4
<b>GPT</b>	T2: H2, J3		

BRABUS

RENAULT

SMART

pcmflash.ru

v.1

2021-10-31

# PCMflash

Engine Control Unit

## MEG17.9.21 TC1724

### Connection version 1

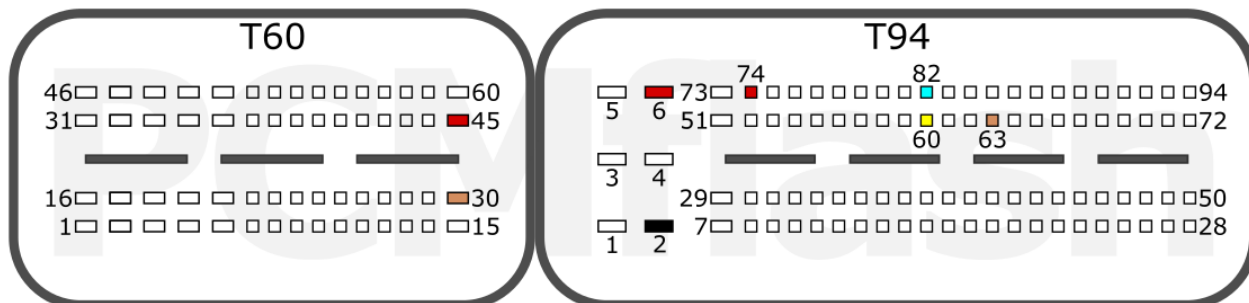

<b>+12V</b>	T60: 45, T94: 6, 74	<b>CAN-L</b>	T94: 82
<b>GND</b>	T94: 2	<b>CAN-H</b>	T94: 60
<b>GPT</b>	T60: 30, T94: 63		

### Connection version 2

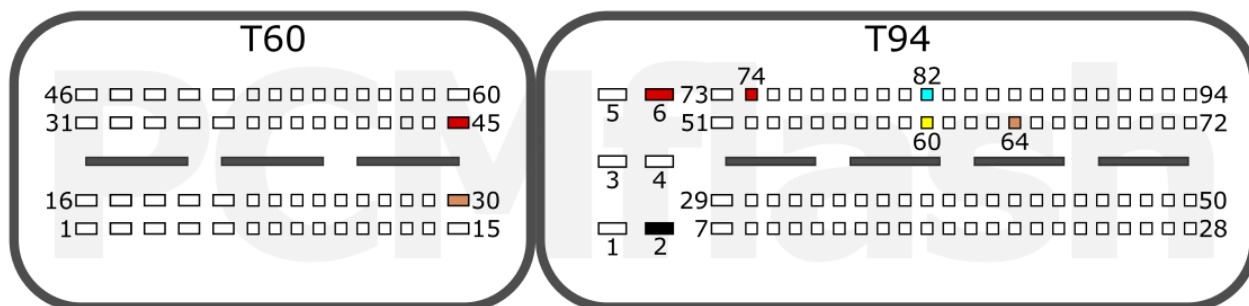

<b>+12V</b>	T60: 45, T94: 6, 74	<b>CAN-L</b>	T94: 82
<b>GND</b>	T94: 2	<b>CAN-H</b>	T94: 60
<b>GPT</b>	T60: 30, T94: 64		

### Connection version 3

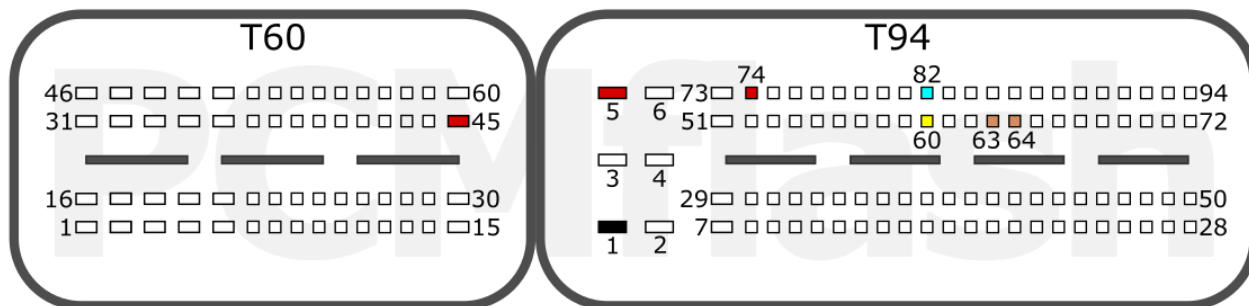

<b>+12V</b>	T60: 45, T94: 5, 74	<b>CAN-L</b>	T94: 82
<b>GND</b>	T94: 1	<b>CAN-H</b>	T94: 60
<b>GPT</b>	T94: 63, 64		

K/H

# PCMflash

Engine Control Unit

ME17.9.21.1 TC1724

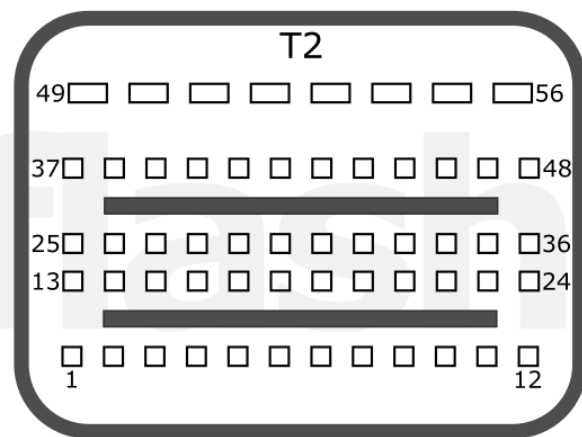
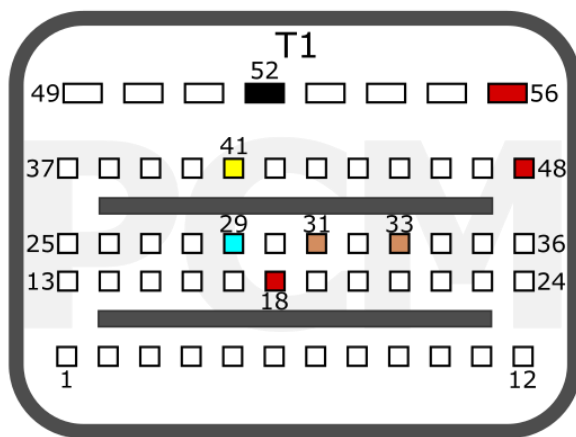

<b>+12V</b>	T1: 56, 48, 18	<b>CAN-L</b>	T1: 29
<b>GND</b>	T1: 52	<b>CAN-H</b>	T1: 41
<b>GPT</b>	T1: 31, 33		

K/H

pcmflash.ru

v.2

2023-12-16

# PCMflash

Engine Control Unit

## MEG17.9.22.1 TC1724

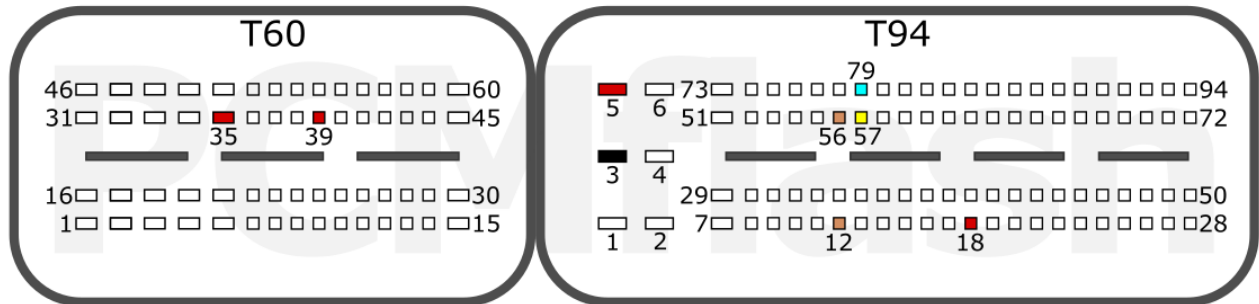

<b>+12V</b>	T60: 35, 39; T94: 5, 18	<b>CAN-L</b>	T94: 79
<b>GND</b>	T94: 3	<b>CAN-H</b>	T94: 57
<b>GPT</b>	T94: 12, 56		

K/H

pcmflash.ru

v.1

2024-06-12



# PCMflash

Engine Control Unit

## MED17.9.30 TC1793

### Connection version 1

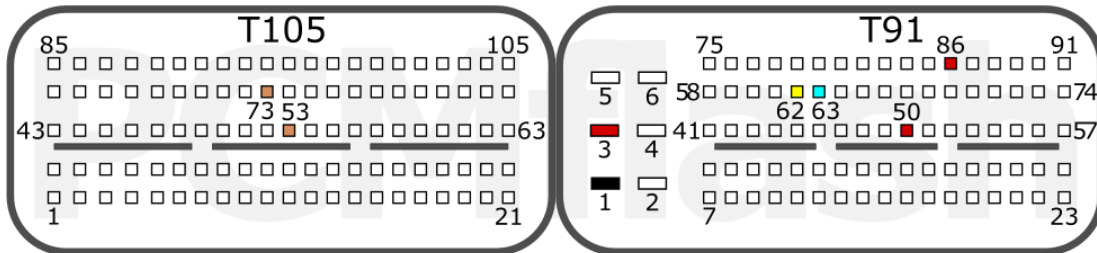

<b>+12V</b>	T91: 3, 50, 86	<b>CAN-L</b>	T91: 63
<b>GND</b>	T91: 1	<b>CAN-H</b>	T91: 62
<b>GPT</b>	T105: 73, 53		

### Connection version 2

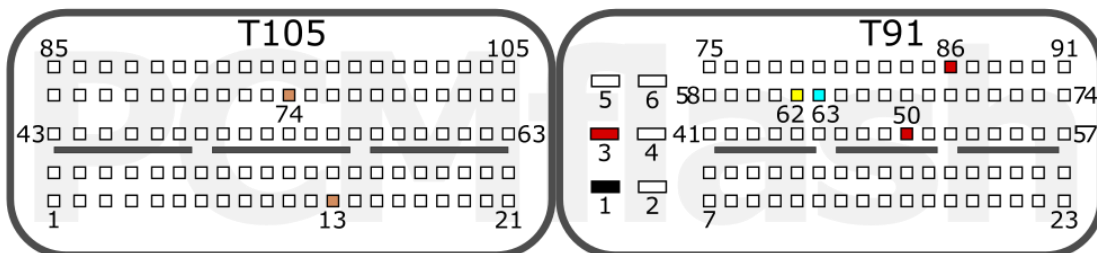

<b>+12V</b>	T91: 3, 50, 86	<b>CAN-L</b>	T91: 63
<b>GND</b>	T91: 1	<b>CAN-H</b>	T91: 62
<b>GPT</b>	T105: 74, 13		

K/H

# PCMflash

Engine Control Unit

## MED17.9.32 TC1782

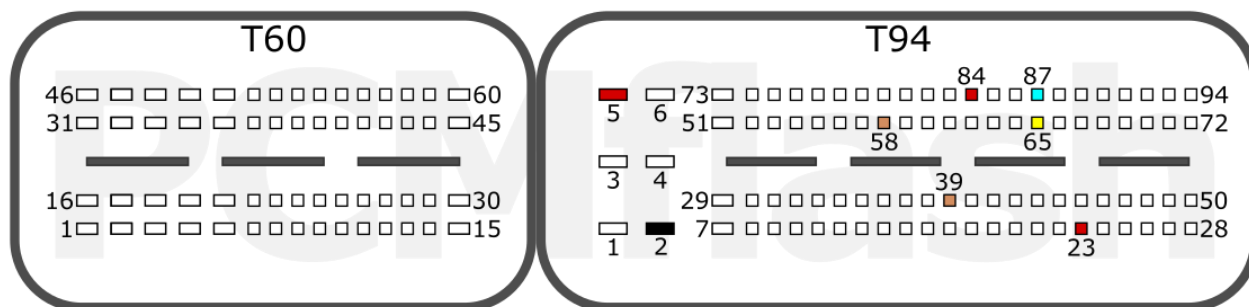

<b>+12V</b>	T94: 2, 23, 84	<b>CAN-L</b>	T94: 87
<b>GND</b>	T94: 2	<b>CAN-H</b>	T94: 65
<b>GPT</b>	T94: 39, 58		

SSANGYONG

pcmflash.ru

v.1

2024-12-17

# PCMflash

Engine Control Unit

## ME17.9.51 TC1762

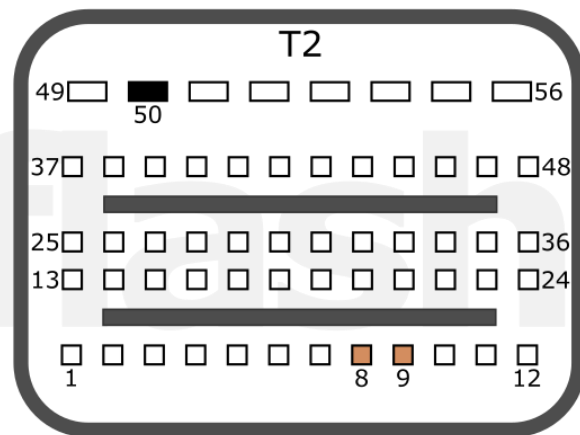
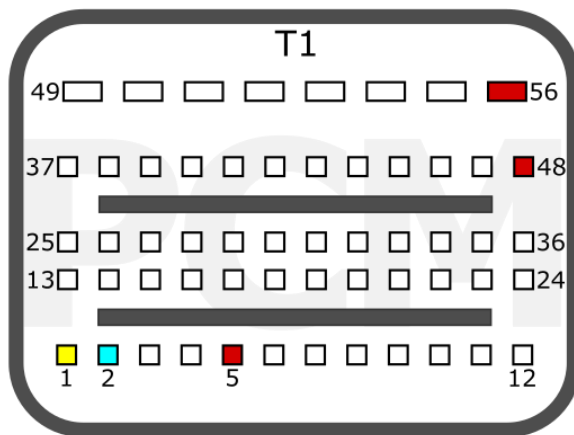

<b>+12V</b>	T1: 56, 48, 5	<b>CAN-L</b>	T1: 2
<b>GND</b>	T2: 50	<b>CAN-H</b>	T1: 1
<b>GPT</b>	T2: 9, 8		

SUZUKI

pcmflash.ru

v.2

2024-08-13

# PCMflash

Engine Control Unit

ME17.9.52 TC1782

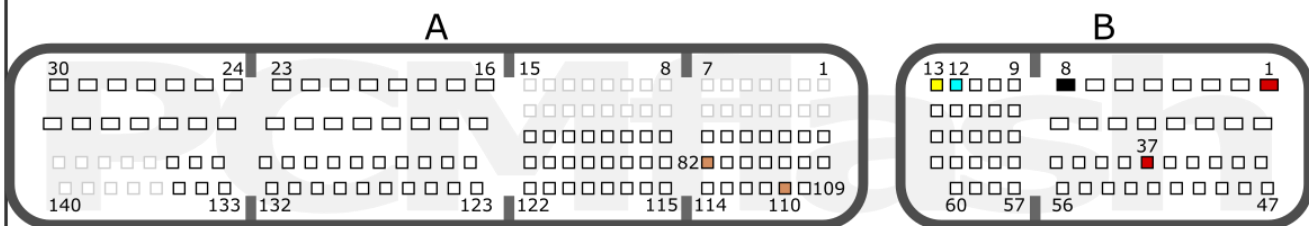

<b>+12V</b>	B: 1, 37	<b>CAN-L</b>	B: 12
<b>GND</b>	B: 8	<b>CAN-H</b>	B: 13
<b>GPT</b>	A: 110, 82		

TOYOTA

pcmflash.ru

v.2

2024-09-19

# PCMflash

Engine Control Unit

ME17.9.53 TC1782

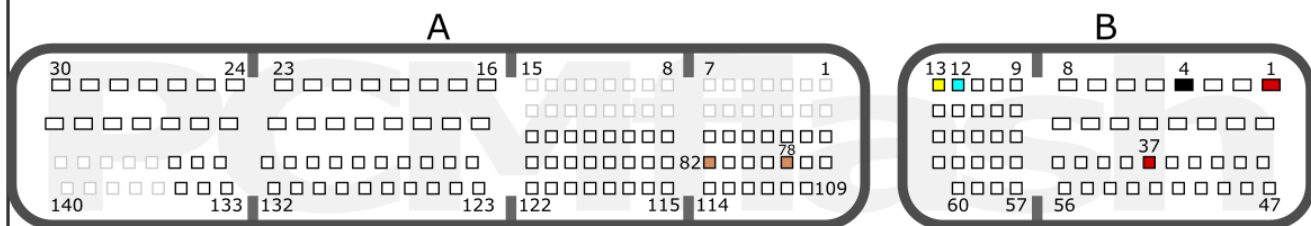

<b>+12V</b>	B: 1, 37	<b>CAN-L</b>	B: 12
<b>GND</b>	B: 4	<b>CAN-H</b>	B: 13
<b>GPT</b>	A: 78, 82		

TOYOTA

pcmflash.ru

v.1

2024-09-19



# PCMflash

Engine Control Unit

## ME17.9.61 TC1724

### Connection version 1

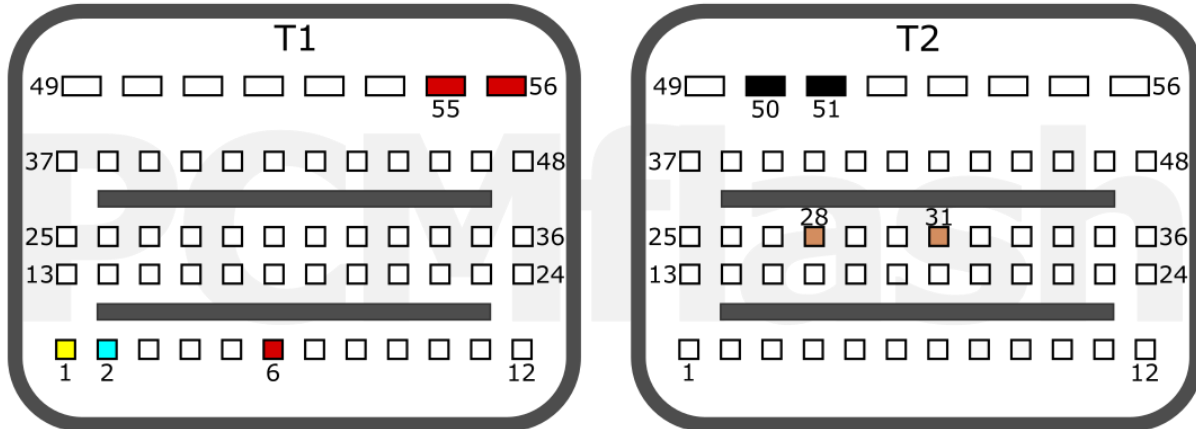

<b>+12V</b>	T1: 55, 56, 6	<b>CAN-L</b>	T1: 2
<b>GND</b>	T2: 50, 51	<b>CAN-H</b>	T1: 1
<b>GPT</b>	T2: 28, 31		

### Connection version 2

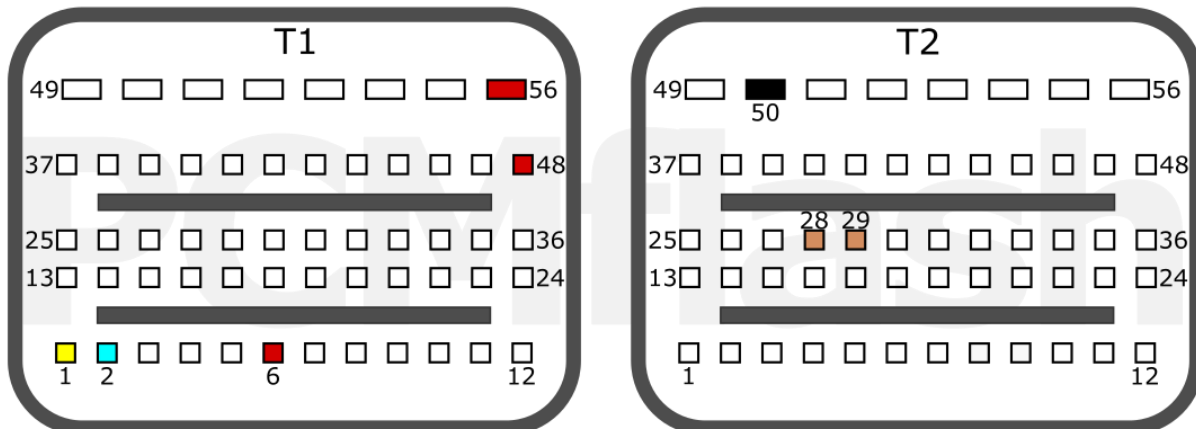

<b>+12V</b>	T1: 56, 48, 6	<b>CAN-L</b>	T1: 2
<b>GND</b>	T2: 50	<b>CAN-H</b>	T1: 1
<b>GPT</b>	T2: 29, 28		

SUZUKI

pcmflash.ru

v.1

2021-09-28

# PCMflash

Engine Control Unit

## MED17.9.63 TC1793

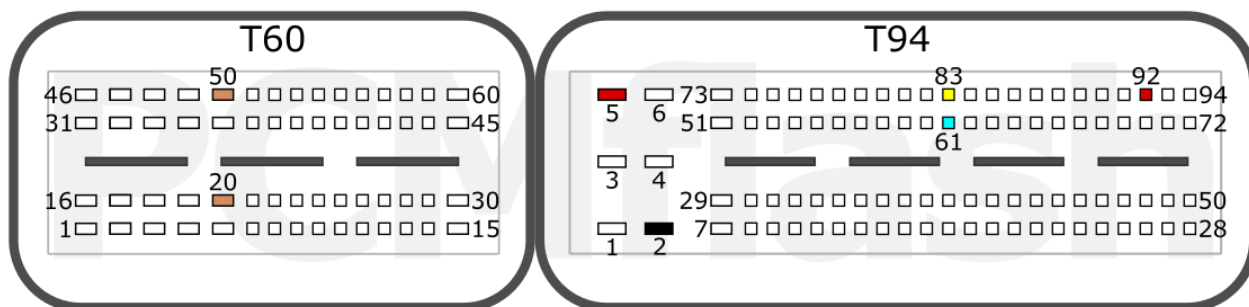

<b>+12V</b>	T94: 5, 92	<b>CAN-L</b>	T94: 61
<b>GND</b>	T94: 2	<b>CAN-H</b>	T94: 83
<b>GPT</b>	T60: 20, 50		

SUZUKI

pcmflash.ru

v.1

2021-12-03



# PCMflash

Engine Control Unit

## ME17.9.64 TC1724

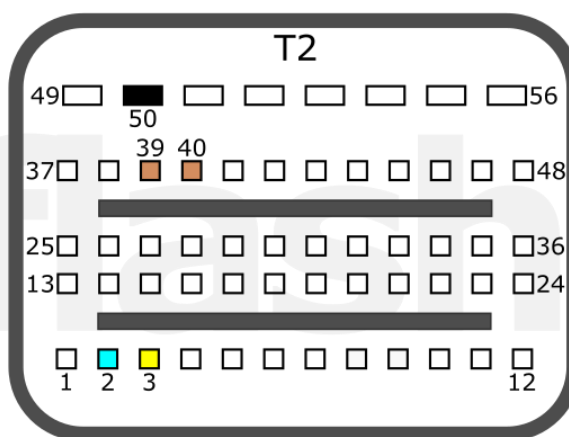
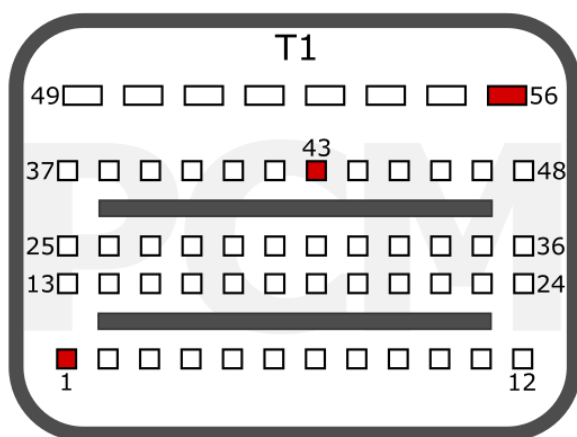

<b>+12V</b>	T1: 1, 43, 56	<b>CAN-L</b>	T2: 2
<b>GND</b>	T2: 50	<b>CAN-H</b>	T2: 3
<b>GPT</b>	T2: 39, 40		

SUZUKI

pcmflash.ru

v.1

2021-12-06

# PCMflash

Engine Control Unit

## MED17.9.66 TC1793

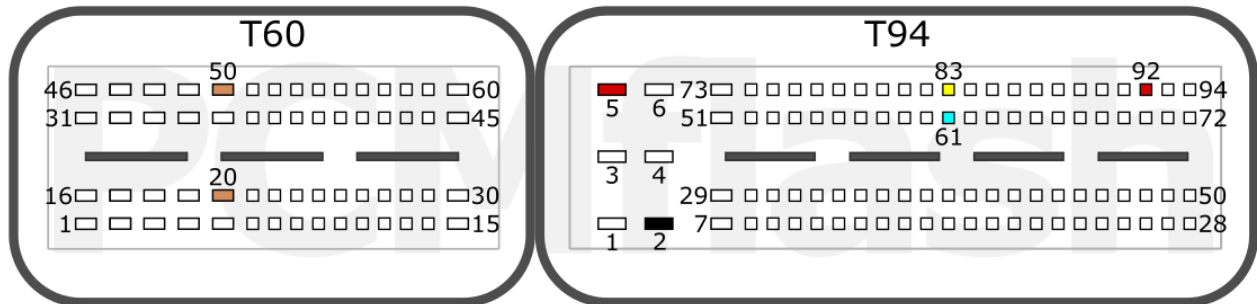

<b>+12V</b>	T94: 5, 92	<b>CAN-L</b>	T94: 61
<b>GND</b>	T94: 2	<b>CAN-H</b>	T94: 83
<b>GPT</b>	T60: 20, 50		

SUZUKI

pcmflash.ru

v.1

2024-08-28

# PCMflash

Engine Control Unit

ME17.9.71 TC1724

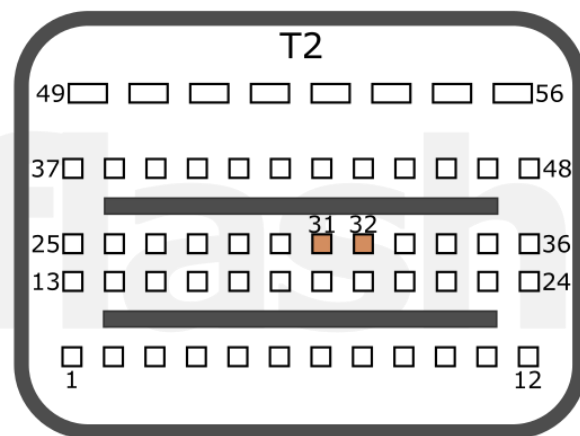
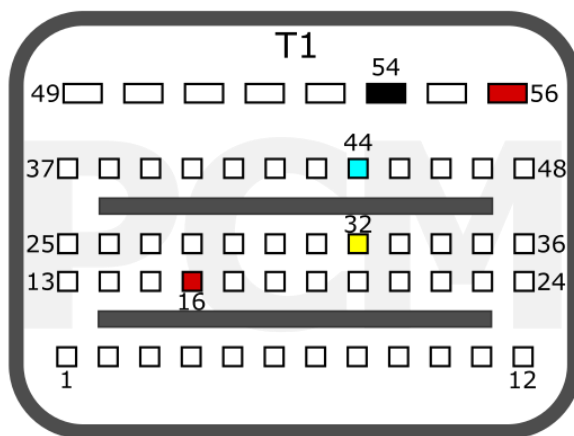

<b>+12V</b>	T1: 56, 16	<b>CAN-L</b>	T1: 44
<b>GND</b>	T1: 54	<b>CAN-H</b>	T1: 32
<b>GPT</b>	T2: 31, 32		

To unlock, read the stock and write it down.  
When recording, check the "unlock" box.

NIVA

UAZ

pcmflash.ru

v.1

2021-08-29

# PCMflash

Engine Control Unit

ME17.9.74 TC1762

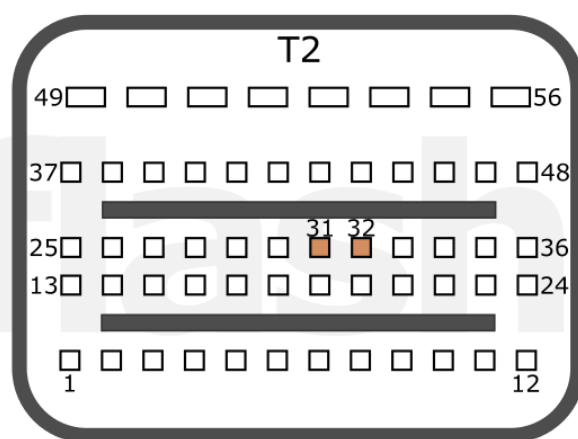
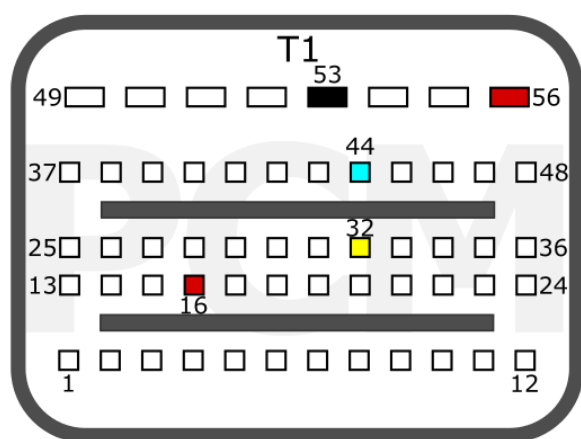

<b>+12V</b>	T1: 56, 16	<b>CAN-L</b>	T1: 44
<b>GND</b>	T1: 53	<b>CAN-H</b>	T1: 32
<b>GPT</b>	T2: 32, 31		

POLARIS

pcmflash.ru

v.1

2023-08-12

# PCMflash

Engine Control Unit

## EDC17C06 TC1766

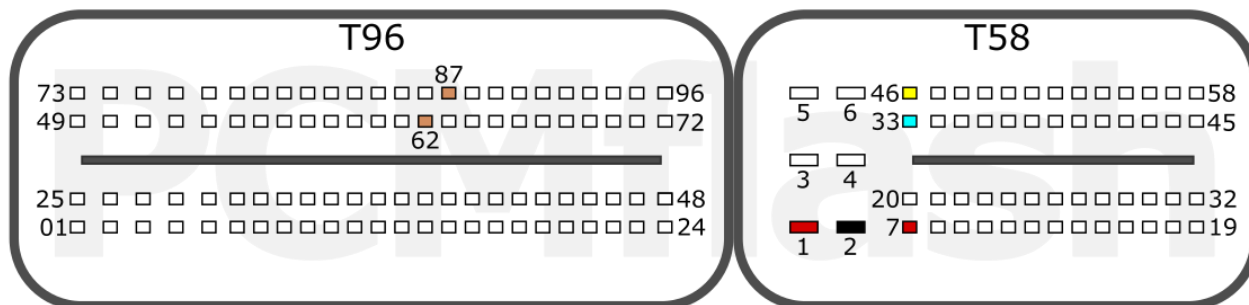

<b>+12V</b>	T58: 1, 7	<b>CAN-L</b>	T58: 33
<b>GND</b>	T58: 2	<b>CAN-H</b>	T58: 46
<b>GPT</b>	T96: 62, 87		

BMW

pcmflash.ru

v.1

2021-09-25

# PCMflash

Engine Control Unit

## EDC17C08 TC1766

### Connection version 1

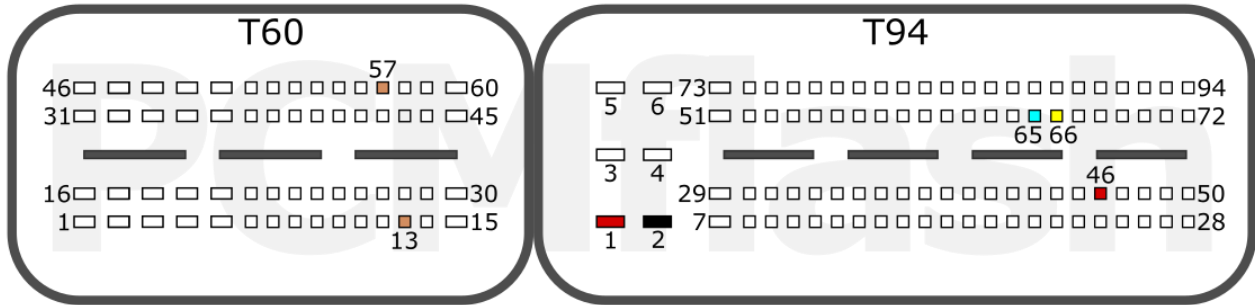

<b>+12V</b>	T94: 1, 46	<b>CAN-L</b>	T94: 65
<b>GND</b>	T94: 2	<b>CAN-H</b>	T94: 66
<b>GPT</b>	T60: 13, 57		

### Connection version 2

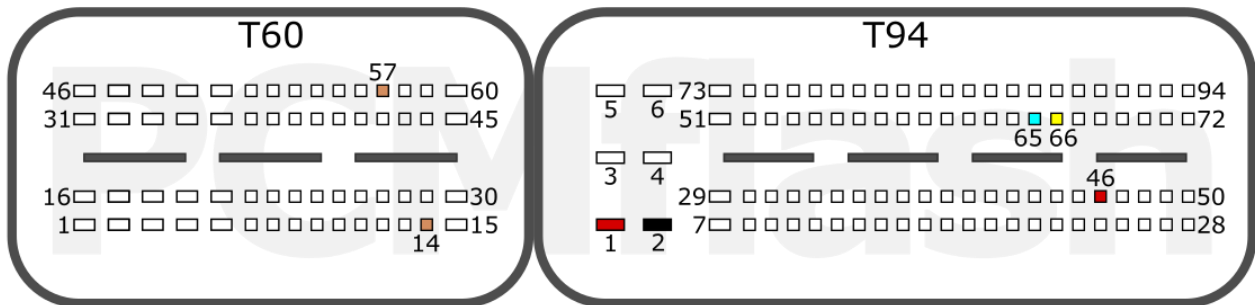

<b>+12V</b>	T94: 1, 46	<b>CAN-L</b>	T94: 65
<b>GND</b>	T94: 2	<b>CAN-H</b>	T94: 66
<b>GPT</b>	T60: 14, 57		

K/H

# PCMflash

Engine Control Unit

## EDC17C10 TC1797

### PSA

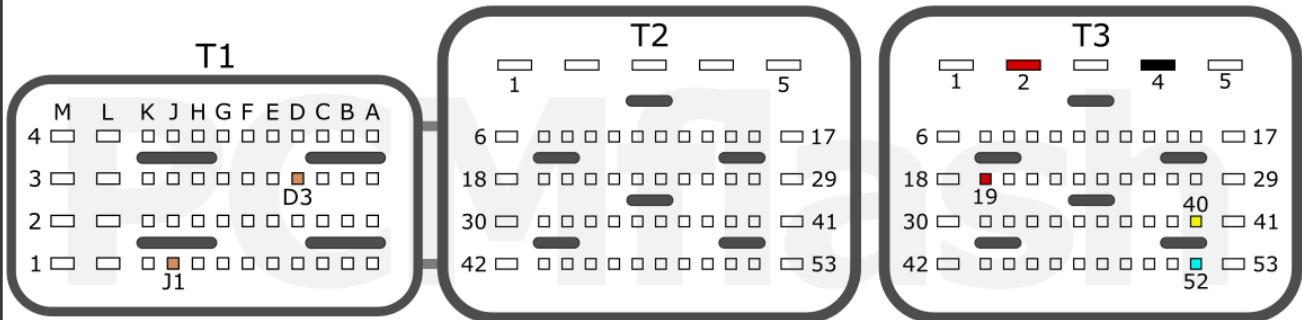

<b>+12V</b>	T3: 2, 19	<b>CAN-L</b>	T3: 52
<b>GND</b>	T3: 4	<b>CAN-H</b>	T3: 40
<b>GPT</b>	T1: J1, D3		

### FORD

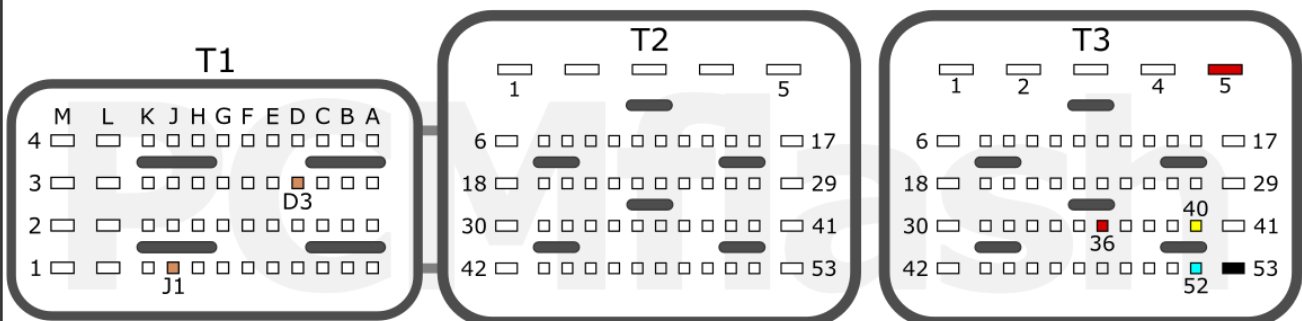

<b>+12V</b>	T3: 5, 36	<b>CAN-L</b>	T3: 52
<b>GND</b>	T3: 53	<b>CAN-H</b>	T3: 40
<b>GPT</b>	T1: J1, D3		

FORD

PSA

pcmflash.ru

v.2

2021-10-11

# PCMflash

Engine Control Unit

## EDC17C11 TC1766

### Connection version 1

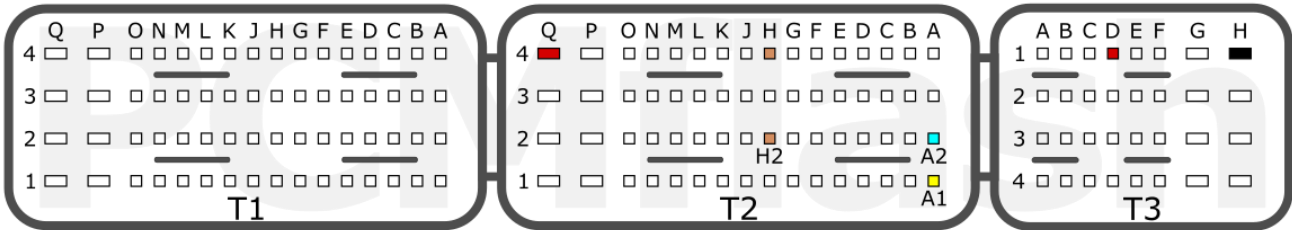

<b>+12V</b>	T2: Q4, T3:D1	<b>CAN-L</b>	T2: A2
<b>GND</b>	T3: H1	<b>CAN-H</b>	T2: A1
<b>GPT</b>	T2: H2, H4		

### Connection version 2

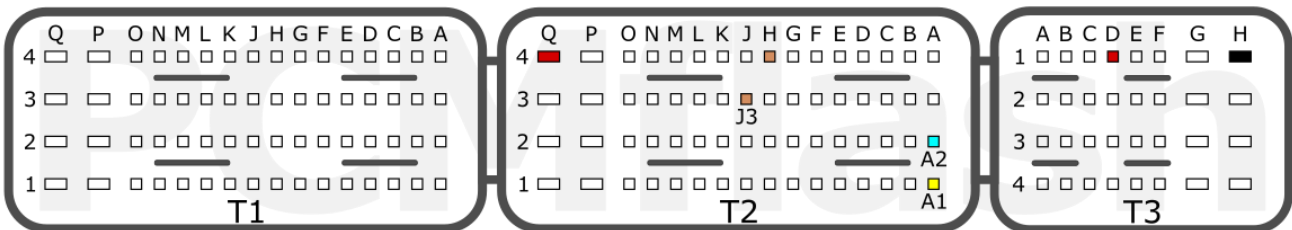

<b>+12V</b>	T2: Q4, T3:D1	<b>CAN-L</b>	T2: A2
<b>GND</b>	T3: H1	<b>CAN-H</b>	T2: A1
<b>GPT</b>	T2: H4, J3		

NISSAN

OPEL

RENAULT

pcmflash.ru

v.1

2021-09-29



# PCMflash

Engine Control Unit

## EDC17C18 TC1766

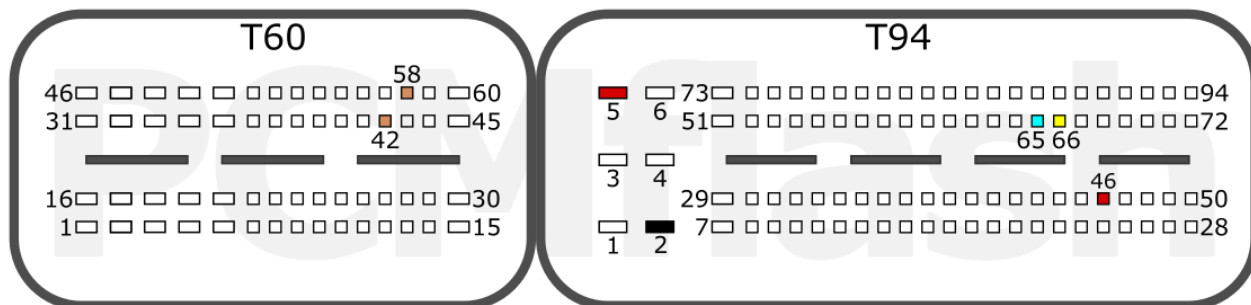

<b>+12V</b>	T94: 5, 46	<b>CAN-L</b>	T94: 65
<b>GND</b>	T94: 2	<b>CAN-H</b>	T94: 66
<b>GPT</b>	T60: 42, 58		

OPEL

pcmflash.ru

v.1

2021-09-30

# PCMflash

Engine Control Unit

## EDC17C19 TC1792

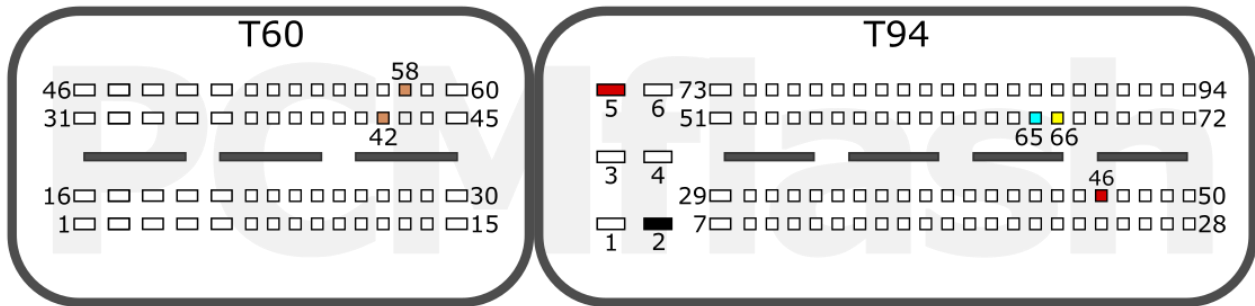

<b>+12V</b>	T94: 5, 46	<b>CAN-L</b>	T94: 65
<b>GND</b>	T94: 2	<b>CAN-H</b>	T94: 66
<b>GPT</b>	T60: 42, 58		

OPEL

pcmflash.ru

v.1

2021-09-25

# PCMflash

Engine Control Unit

## EDC17C41 TC1797

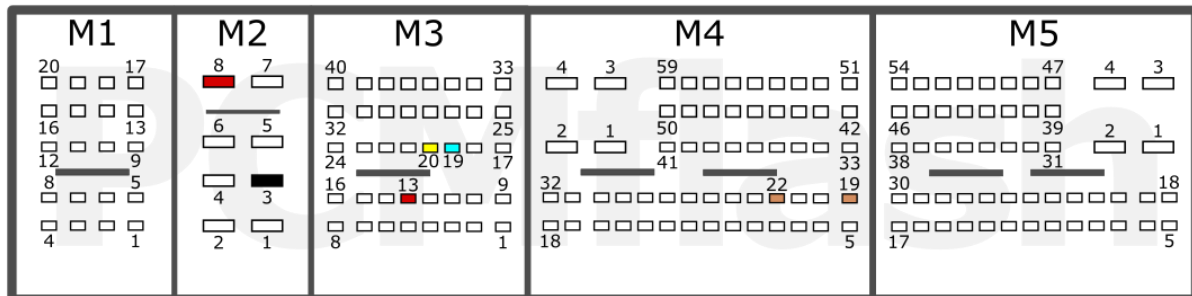

<b>+12V</b>	M2: 8; M3: 13	<b>CAN-L</b>	M3: 19
<b>GND</b>	M2: 3	<b>CAN-H</b>	M3: 20
<b>GPT</b>	M4: 22, 19		

BMW

pcmflash.ru

v.1

2022-01-24

# PCMflash

Engine Control Unit

## EDC17C42 TC1767

### Connection version 1

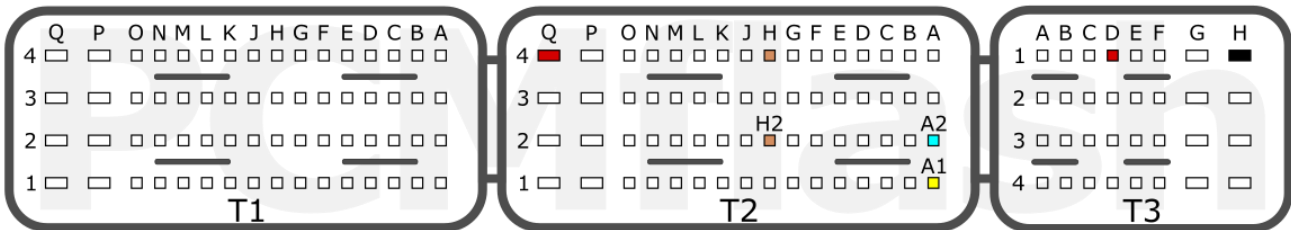

<b>+12V</b>	T2: Q4, T3:D1	<b>CAN-L</b>	T2: A2
<b>GND</b>	T3: H1	<b>CAN-H</b>	T2: A1
<b>GPT</b>	T2: H2, H4		

### Connection version 2

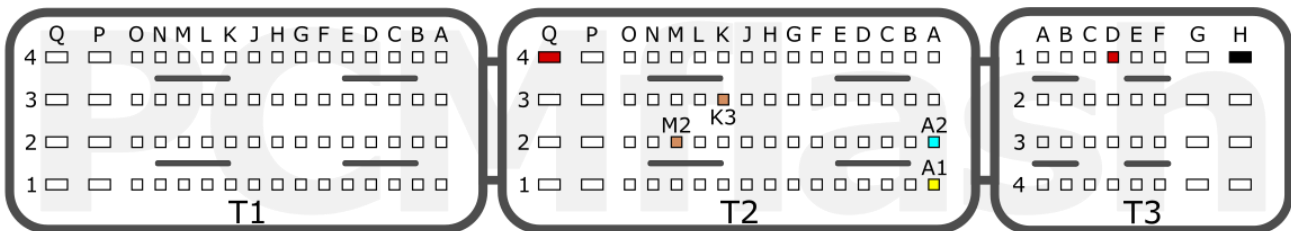

<b>+12V</b>	T2: Q4, T3:D1	<b>CAN-L</b>	T2: A2
<b>GND</b>	T3: H1	<b>CAN-H</b>	T2: A1
<b>GPT</b>	T2: M2, K3		

### Connection version 3

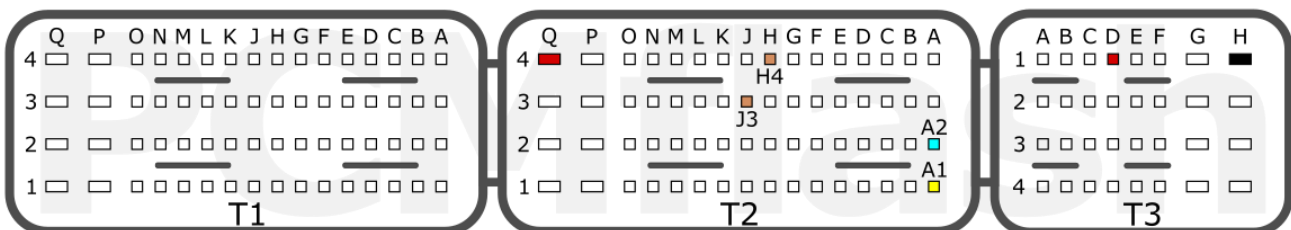

<b>+12V</b>	T2: Q4, T3:D1	<b>CAN-L</b>	T2: A2
<b>GND</b>	T3: H1	<b>CAN-H</b>	T2: A1
<b>GPT</b>	T2: H4, J3		

RENAULT

pcmflash.ru

v.3

2024-03-06

# PCMflash

Engine Control Unit

EDC17C43 TC1797

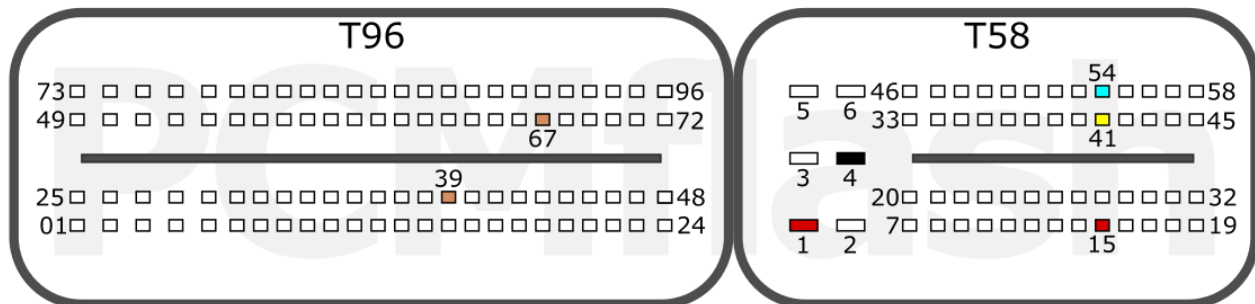

<b>+12V</b>	T58: 1, 15	<b>CAN-L</b>	T58: 54
<b>GND</b>	T58: 4	<b>CAN-H</b>	T58: 41
<b>GPT</b>	T96: 39, 67		

MB

pcmflash.ru

v.1

2022-31-03

## PCMflash

Engine Control Unit

EDC17C45 TC1767



<b>+12V</b>	T58: 5, 56, 19	<b>CAN-L</b>	T58: 50
<b>GND</b>	T58: 2	<b>CAN-H</b>	T58: 49
<b>GPT</b>	T96: 67, T58:11		

NISSAN

pcmflash.ru

v.1

2021-12-08

# PCMflash

Engine Control Unit

## EDC17C46 TC1767

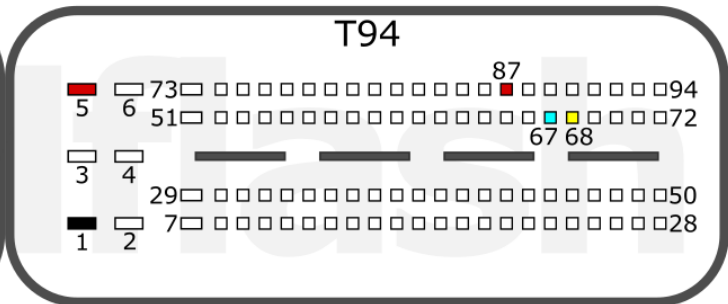
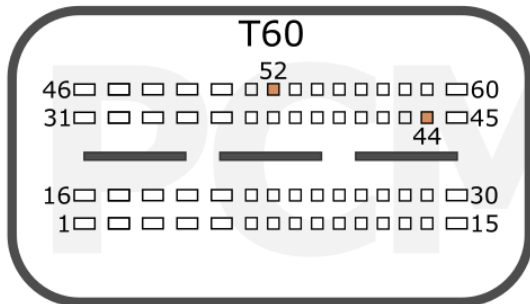

<b>+12V</b>	T94: 5, 87	<b>CAN-L</b>	T94: 67
<b>GND</b>	T94: 1	<b>CAN-H</b>	T94: 68
<b>GPT</b>	T60: 44, 52		

VAG

pcmflash.ru

v.1

2021-08-25

# PCMflash

Engine Control Unit

## EDC17C47 TC1782

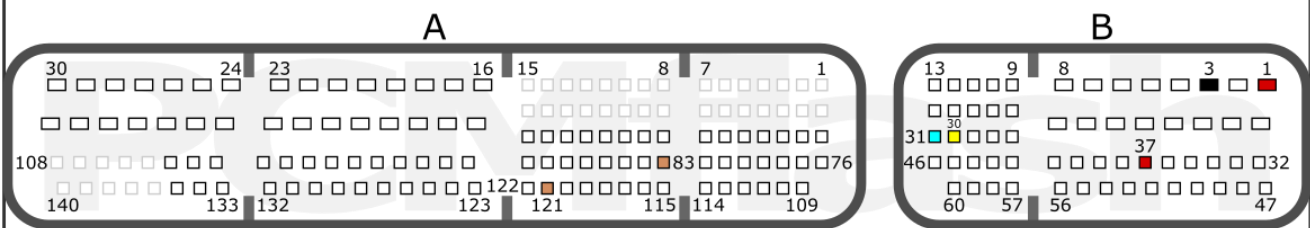

<b>+12V</b>	B: 1, 37	<b>CAN-L</b>	B: 31
<b>GND</b>	B: 3	<b>CAN-H</b>	B: 30
<b>GPT</b>	A: 83, 121		

TOYOTA

pcmflash.ru

v.1

2022-06-15



# PCMflash

Engine Control Unit

## EDC17C49 TC1797

### Connection version 1

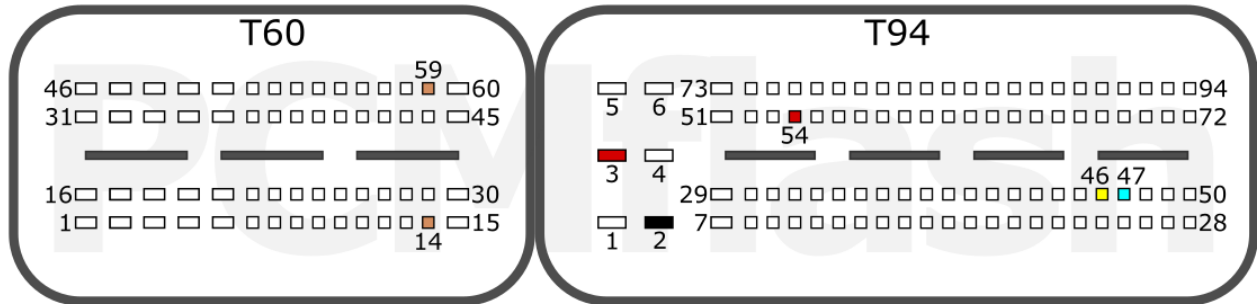

<b>+12V</b>	T94: 3, 54	<b>CAN-L</b>	T94: 47
<b>GND</b>	T94: 2	<b>CAN-H</b>	T94: 46
<b>GPT</b>	T60: 14, 59		

### Connection version 2

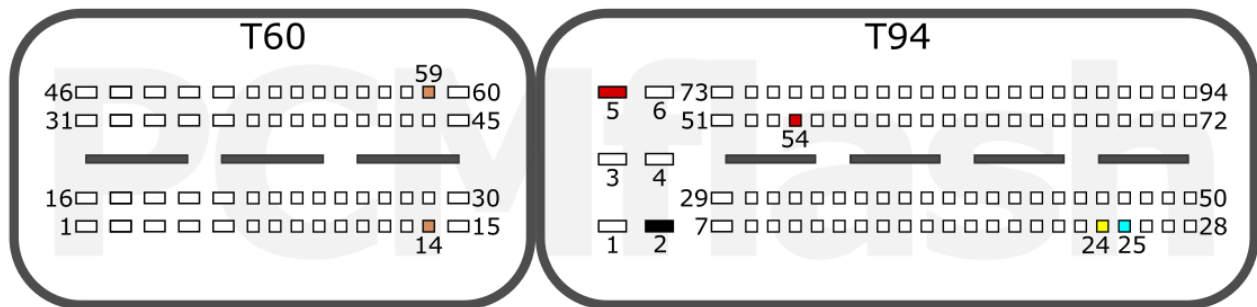

<b>+12V</b>	T94: 5, 54	<b>CAN-L</b>	T94: 25
<b>GND</b>	T94: 2	<b>CAN-H</b>	T94: 24
<b>GPT</b>	T60: 14, 59		

### Connection version 3

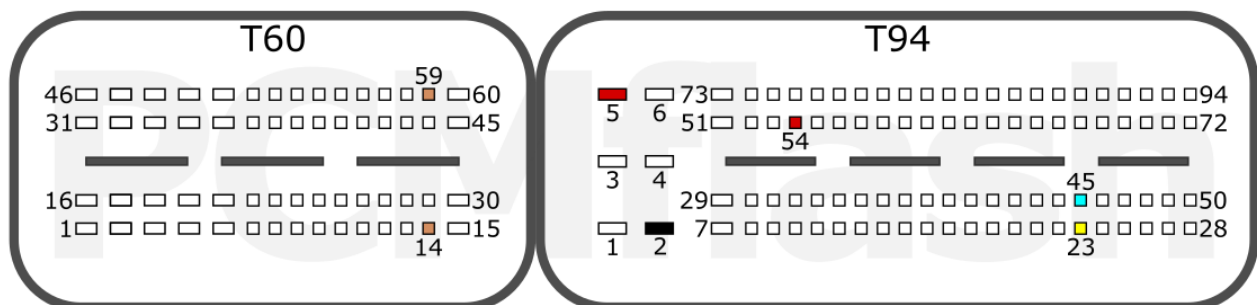

<b>+12V</b>	T94: 5, 54	<b>CAN-L</b>	T94: 45
<b>GND</b>	T94: 2	<b>CAN-H</b>	T94: 23
<b>GPT</b>	T60: 59, 14		

[See the next page/См. следующую страницу](#)

FIAT	JEEP	IVECO	OPEL
pcmflash.ru		v.4	2025-03-20

# PCMflash

Engine Control Unit

## EDC17C49 TC1797

### Connection version 4

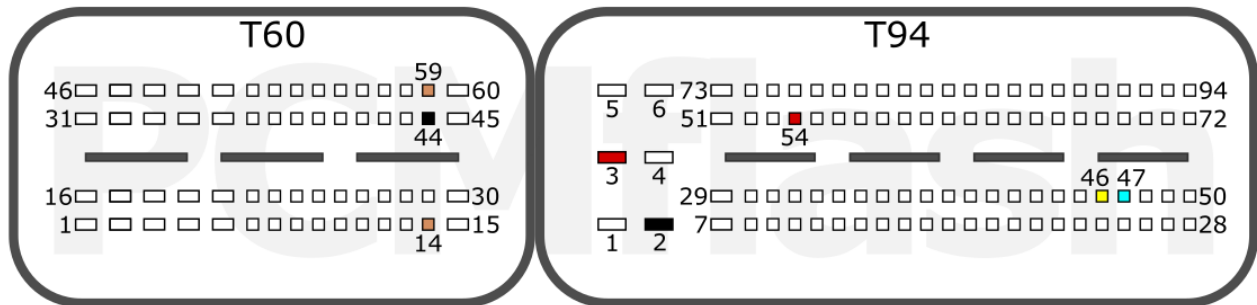

<b>+12V</b>	T94: 3, 54	<b>CAN-L</b>	T94: 47
<b>GND</b>	T60: 44, T94: 2	<b>CAN-H</b>	T94: 46
<b>GPT</b>	T60: 14, 59*		

### Connection version 5

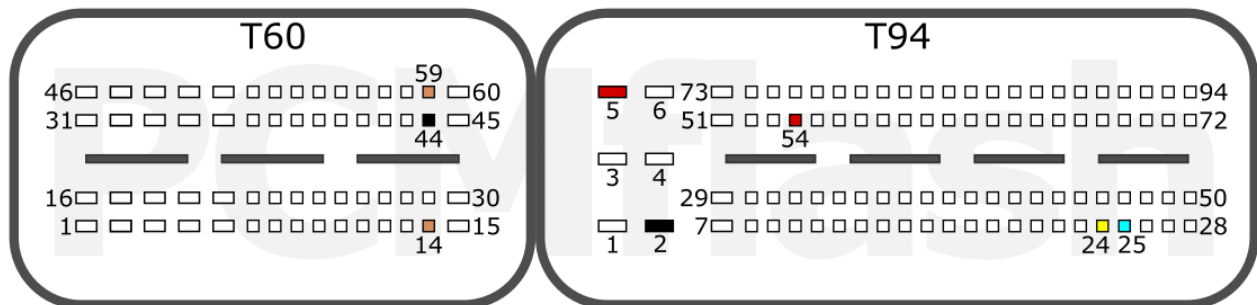

<b>+12V</b>	T94: 5, 54	<b>CAN-L</b>	T94: 25
<b>GND</b>	T60: 44, T94: 2	<b>CAN-H</b>	T94: 24
<b>GPT</b>	T60: 14, 59*		

### Connection version 6

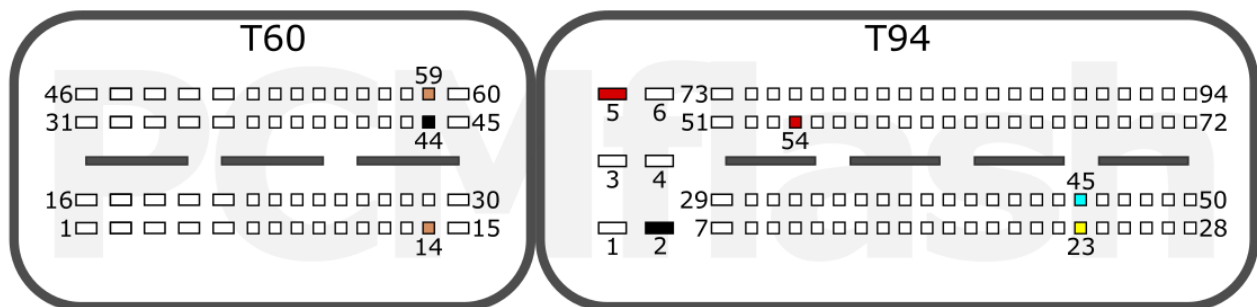

<b>+12V</b>	T94: 5, 54	<b>CAN-L</b>	T94: 45
<b>GND</b>	T60: 44, T94: 2	<b>CAN-H</b>	T94: 23
<b>GPT</b>	T60: 14, 59*		

\*10-47 uF 50v capacitor required on 59 GPT line/

Подключить сигнал 59 GPT к ЭБУ через конденсатор 10-47 мкФ

FIAT	JEEP	IVECO	OPEL
pcmflash.ru		v.4	2025-03-20

# PCMflash

Engine Control Unit

EDC17C50 TC1797

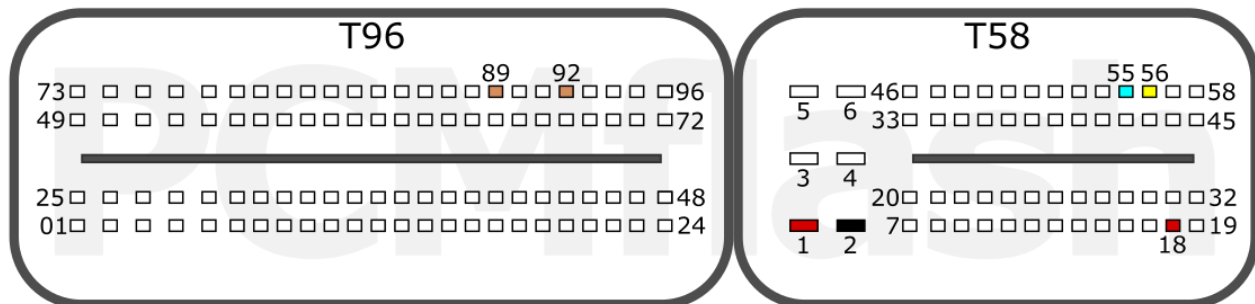

<b>+12V</b>	T58: 1, 18	<b>CAN-L</b>	T58: 55
<b>GND</b>	T58: 2	<b>CAN-H</b>	T58: 56
<b>GPT</b>	T96: 89, 92		

BMW

pcmflash.ru

v.1

2021-09-11

# PCMflash

Engine Control Unit

## EDC17C53 TC1767

### Connection version 1

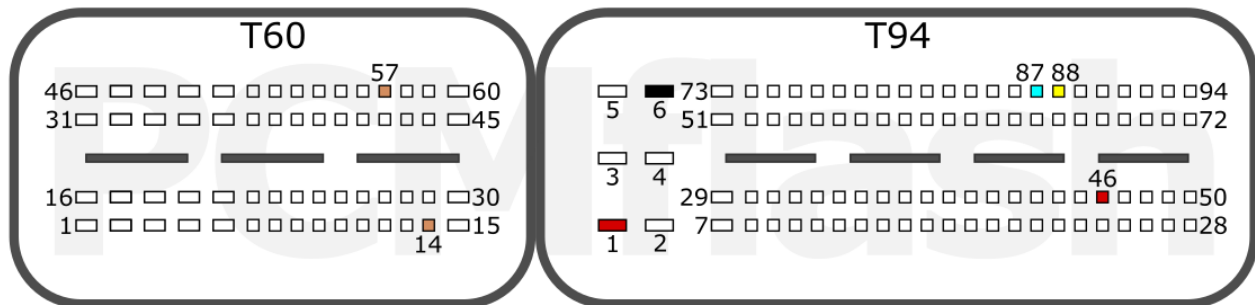

<b>+12V</b>	T94: 1, 46	<b>CAN-L</b>	T94: 87
<b>GND</b>	T94: 6	<b>CAN-H</b>	T94: 88
<b>GPT</b>	T60: 14, 57		

### Connection version 2

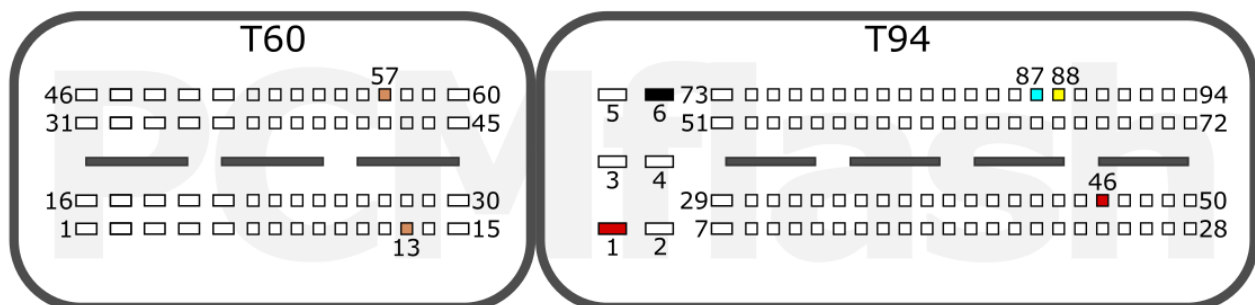

<b>+12V</b>	T94: 1, 46	<b>CAN-L</b>	T94: 87
<b>GND</b>	T94: 6	<b>CAN-H</b>	T94: 88
<b>GPT</b>	T60: 13, 57		

HAVAL

JAC

K/H

pcmflash.ru

v.3

2024-10-23

# PCMflash

Engine Control Unit

## EDC17C54 TC1797

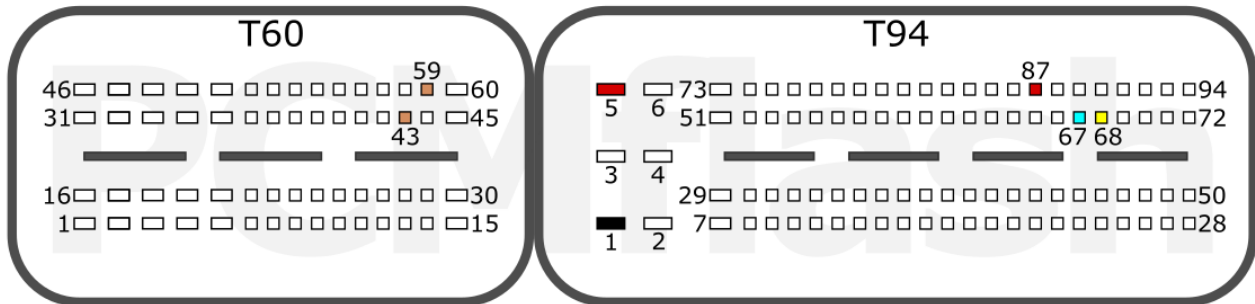

<b>+12V</b>	T94: 5, 87	<b>CAN-L</b>	T94: 67
<b>GND</b>	T94: 1	<b>CAN-H</b>	T94: 68
<b>GPT</b>	T60: 43, 59		

VAG

pcmflash.ru

v.1

2021-08-29

# PCMflash

Engine Control Unit

EDC17C55 TC1767

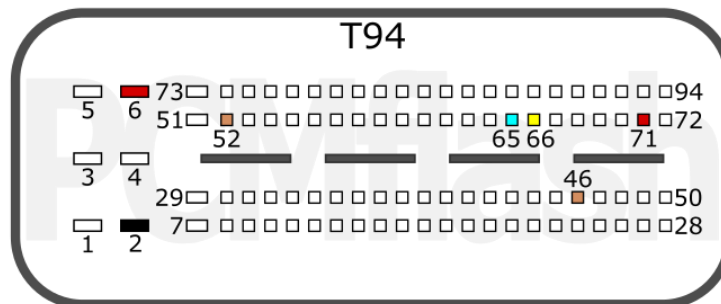

<b>+12V</b>	6, 71	<b>CAN-L</b>	65
<b>GND</b>	2	<b>CAN-H</b>	66
<b>GPT</b>	46, 52		

ALL

pcmflash.ru

v.1

2024-08-05

# PCMflash

Engine Control Unit

## EDC17C56 TC1797

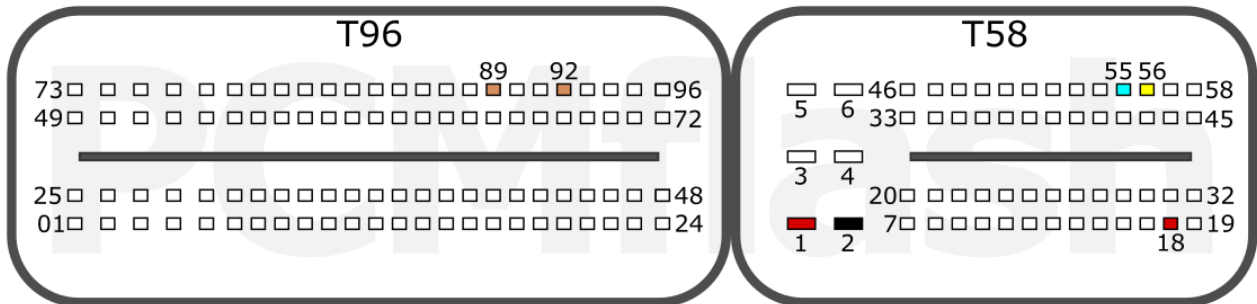

<b>+12V</b>	T58: 1, 18	<b>CAN-L</b>	T58: 55
<b>GND</b>	T58: 2	<b>CAN-H</b>	T58: 56
<b>GPT</b>	T96: 92, 89		

BMW

pcmflash.ru

v.1

2021-08-25

# PCMflash

Engine Control Unit

## EDC17C57 TC1793

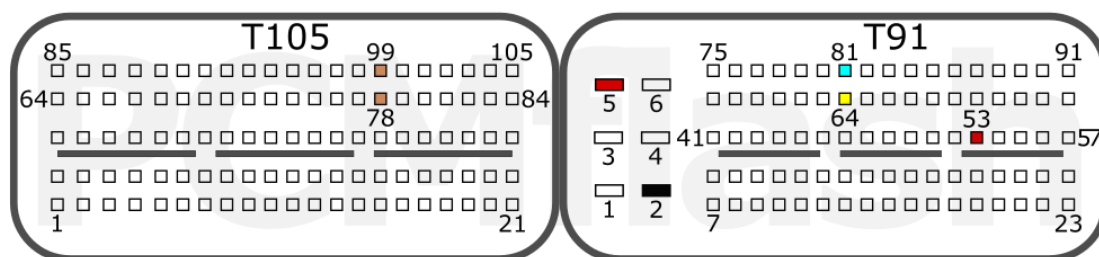

<b>+12V</b>	T91: 5, 53	<b>CAN-L</b>	T91: 81
<b>GND</b>	T91: 2	<b>CAN-H</b>	T91: 64
<b>GPT</b>	T105: 99, 78		

K/H

pcmflash.ru

v.1

2021-08-26



# PCMflash

Engine Control Unit

## EDC17C58 TC1793

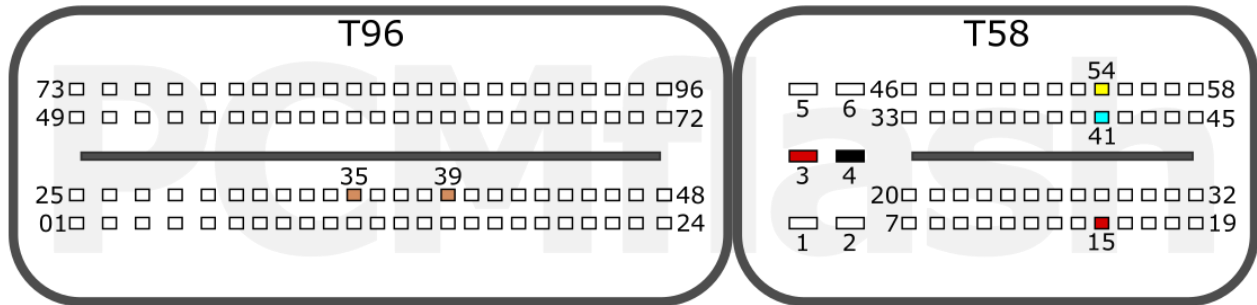

<b>+12V</b>	T58: 3, 15	<b>CAN-L</b>	T58: 41
<b>GND</b>	T58: 4	<b>CAN-H</b>	T58: 54
<b>GPT</b>	T96: 35, 39		

HONDA

# PCMflash

Engine Control Unit

## EDC17C59 TC1767

### 1.3-LITRE ENGINE

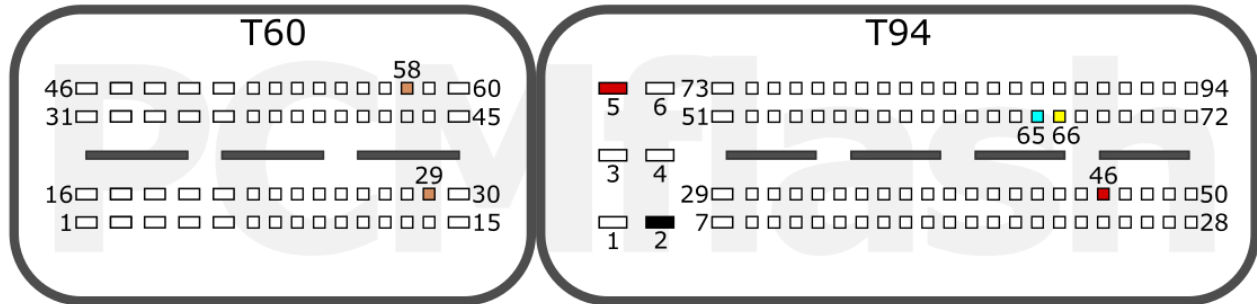

<b>+12V</b>	T94: 5, 46	<b>CAN-L</b>	T94: 65
<b>GND</b>	T94: 2	<b>CAN-H</b>	T94: 66
<b>GPT</b>	T60: 29, 58		

### 2.0-LITRE ENGINE

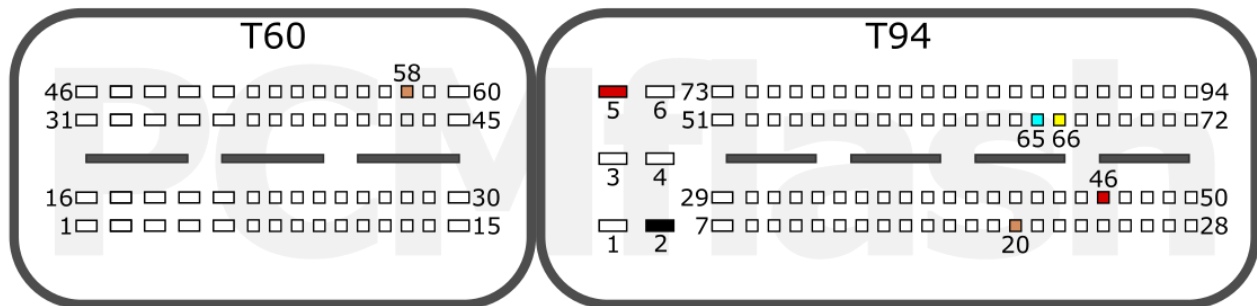

<b>+12V</b>	T94: 5, 46	<b>CAN-L</b>	T94: 65
<b>GND</b>	T94: 2	<b>CAN-H</b>	T94: 66
<b>GPT</b>	T60: 58, T94: 20		

OPEL

pcmflash.ru

v.1

2021-09-11

# PCMflash

Engine Control Unit

## EDC17C60 TC1793

### Connection version 1

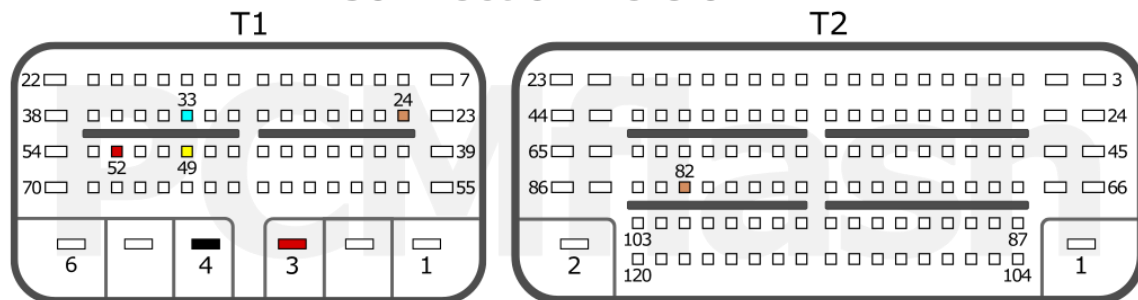

<b>+12V</b>	T1: 52, 3	<b>CAN-L</b>	T1: 33
<b>GND</b>	T1: 4	<b>CAN-H</b>	T1: 49
<b>GPT</b>	T1: 24, T2:82		

### Connection version 2

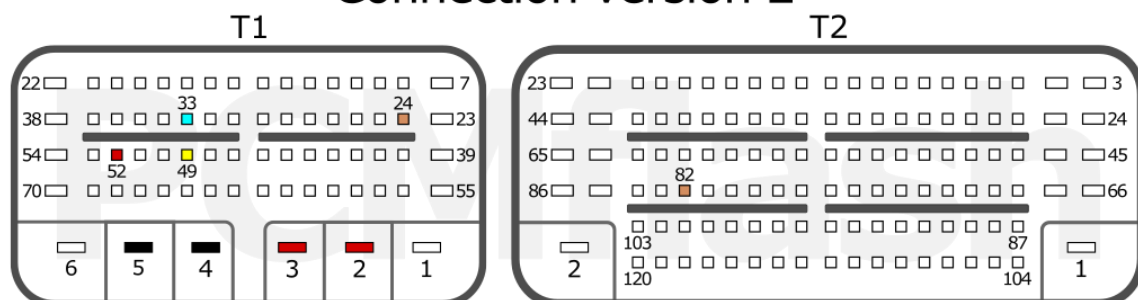

<b>+12V</b>	T1: 52, 3, 2	<b>CAN-L</b>	T1: 33
<b>GND</b>	T1: 4, 5	<b>CAN-H</b>	T1: 49
<b>GPT</b>	T1: 24, T2:82		

PSA

pcmflash.ru

v.1

2021-11-01

# PCMflash

Engine Control Unit

## EDC17C63 TC1724

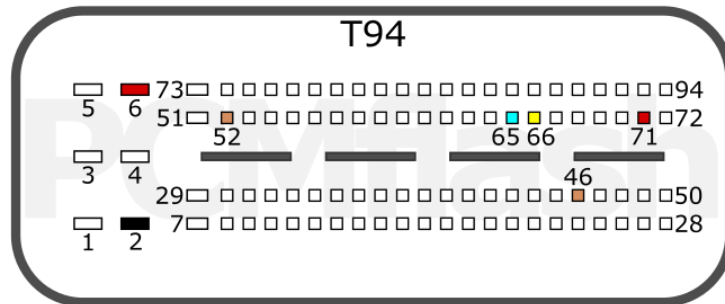

<b>+12V</b>	T94: 6, 71	<b>CAN-L</b>	T94: 65
<b>GND</b>	T94: 2	<b>CAN-H</b>	T94: 66
<b>GPT</b>	T94: 46, 52		

ISUZU

pcmflash.ru

v.2

2024-10-03

# PCMflash

Engine Control Unit

## EDC17C64 TC1797

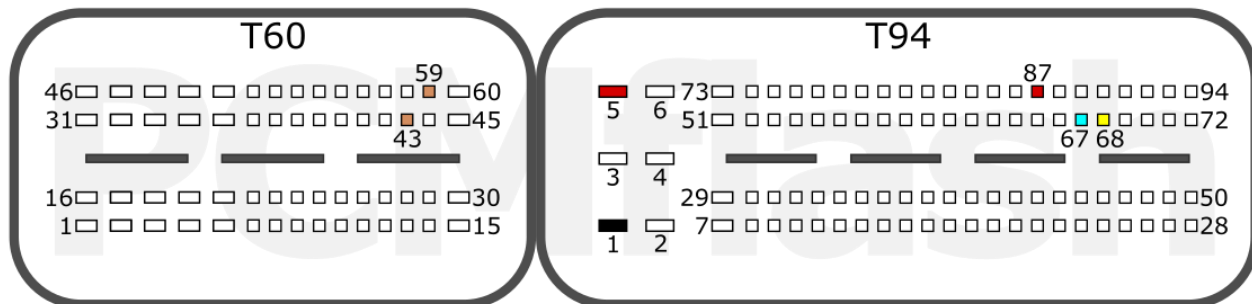

<b>+12V</b>	T94: 5, 87	<b>CAN-L</b>	T94: 67
<b>GND</b>	T94: 1	<b>CAN-H</b>	T94: 68
<b>GPT</b>	T60: 59, 43		

SEAT

pcmflash.ru

v.1

2021-10-07

# PCMflash

Engine Control Unit

## EDC17C66 TC1793



<b>+12V</b>	T58: 3, 15	<b>CAN-L</b>	T58: 54
<b>GND</b>	T58: 2	<b>CAN-H</b>	T58: 41
<b>GPT</b>	T96: 35, 39		

MB

pcmflash.ru

v.1

2021-09-09

# PCMflash

Engine Control Unit

## EDC17C69 TC1793

### Connection version 1

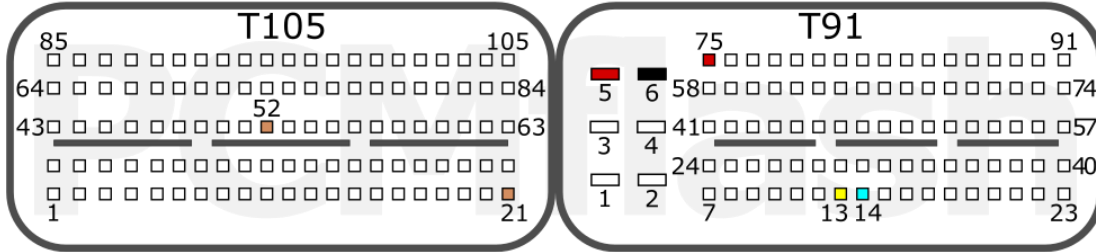

<b>+12V</b>	T91: 5, 75	<b>CAN-L</b>	T91: 14
<b>GND</b>	T91: 6	<b>CAN-H</b>	T91: 13
<b>GPT</b>	T105: 52, 21		

### Connection version 2

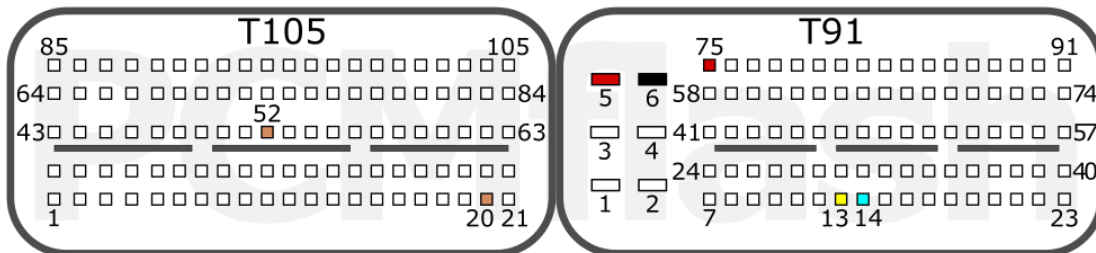

<b>+12V</b>	T91: 5, 75	<b>CAN-L</b>	T91: 14
<b>GND</b>	T91: 6	<b>CAN-H</b>	T91: 13
<b>GPT</b>	T105: 52, 20		

### Connection version 3

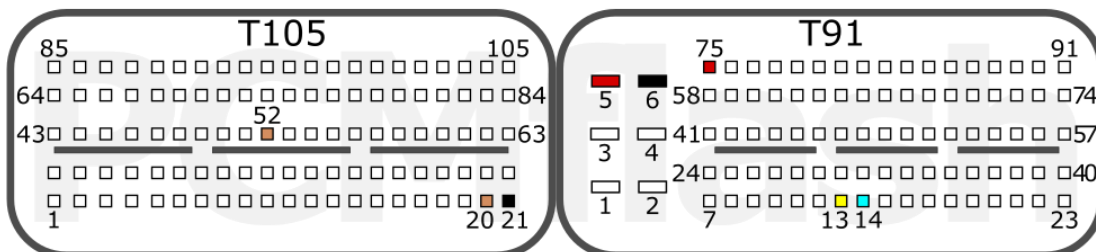

<b>+12V</b>	T91: 5, 75	<b>CAN-L</b>	T91: 14
<b>GND</b>	T105: 21, T91: 6	<b>CAN-H</b>	T91: 13
<b>GPT</b>	T105: 52, 20*		

\*Install 10uF capacitor on 20 GPT line

JEEP

IVECO

pcmflash.ru

v.3

2024-10-03

# PCMflash

Engine Control Unit

## EDC17C70 TC1793

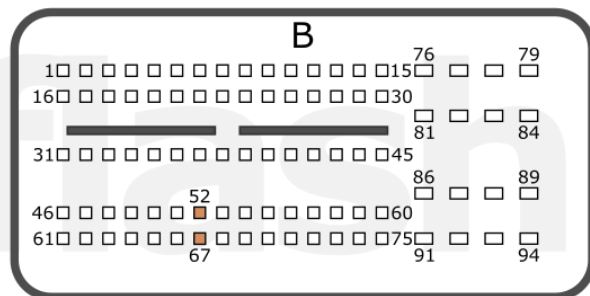
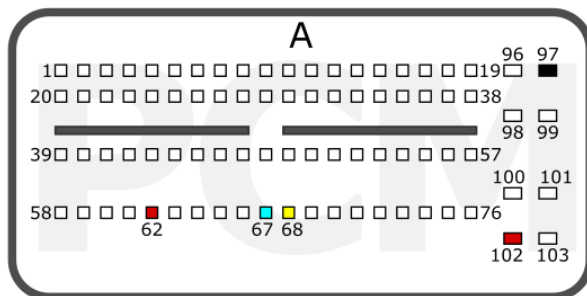

<b>+12V</b>	A: 62, 102	<b>CAN-L</b>	A: 67
<b>GND</b>	A: 97	<b>CAN-H</b>	A: 68
<b>GPT</b>	B: 67, 52		

FORD

pcmflash.ru

v.1

2021-09-08



# PCMflash

Engine Control Unit

## EDC17C73 TC1793

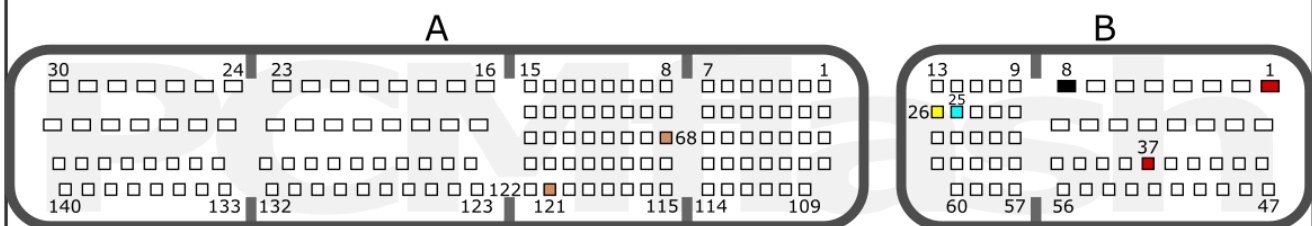

<b>+12V</b>	B: 1, 37	<b>CAN-L</b>	B: 25
<b>GND</b>	B: 8	<b>CAN-H</b>	B: 26
<b>GPT</b>	A: 68, 121		

TOYOTA

pcmflash.ru

v.1

2021-10-08

# PCMflash

Engine Control Unit

## EDC17C74 TC1793

### Connection version 1

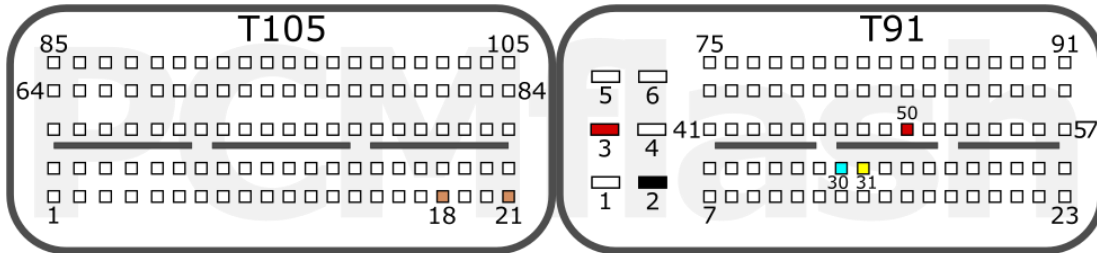

<b>+12V</b>	T91: 3, 50	<b>CAN-L</b>	T91: 30
<b>GND</b>	T91: 2	<b>CAN-H</b>	T91: 31
<b>GPT</b>	T105: 18, 21		

### Connection version 2

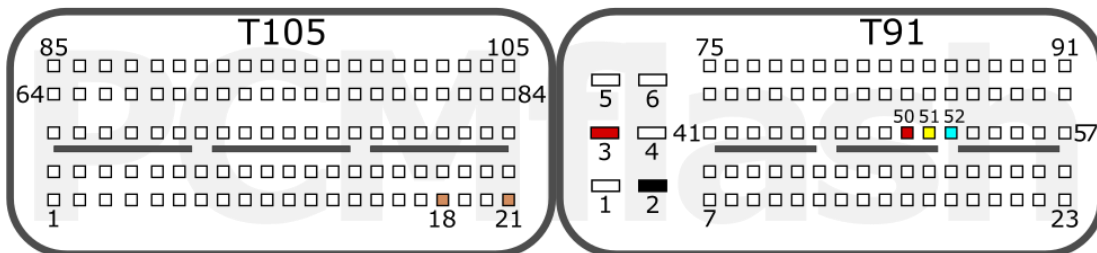

<b>+12V</b>	T91: 3, 50	<b>CAN-L</b>	T91: 52
<b>GND</b>	T91: 2	<b>CAN-H</b>	T91: 51
<b>GPT</b>	T105: 18, 21		

VAG

pcmflash.ru

v.1

2021-10-13

# PCMflash

Engine Control Unit

## EDC17C76 TC1793



<b>+12V</b>	T58: 1, 18	<b>CAN-L</b>	T58: 55
<b>GND</b>	T58: 2	<b>CAN-H</b>	T58: 56
<b>GPT</b>	T96: 92, 89		

BMW

pcmflash.ru

v.1

2023-04-01

# PCMflash

Engine Control Unit

## EDC17C79 TC1797

### Connection version 1

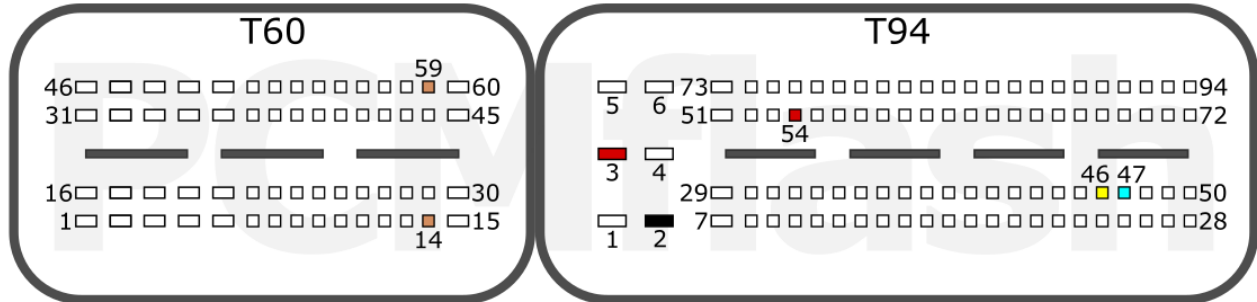

<b>+12V</b>	T94: 3, 54	<b>CAN-L</b>	T94: 47
<b>GND</b>	T94: 2	<b>CAN-H</b>	T94: 46
<b>GPT</b>	T60: 14, 59		

### Connection version 2

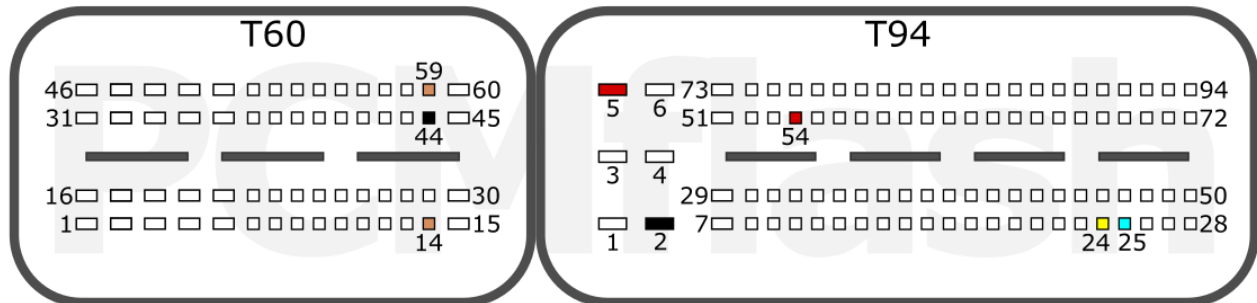

<b>+12V</b>	T94: 5, 54	<b>CAN-L</b>	T94: 25
<b>GND</b>	T60: 44, T94: 2	<b>CAN-H</b>	T94: 24
<b>GPT</b>	T60: 14, 59*		

\*10-47 uF 50v capacitor required on 59 GPT line /  
Подключить сигнал 59 GPT к ЭБУ через конденсатор 10-47 мкФ

### Connection version 3

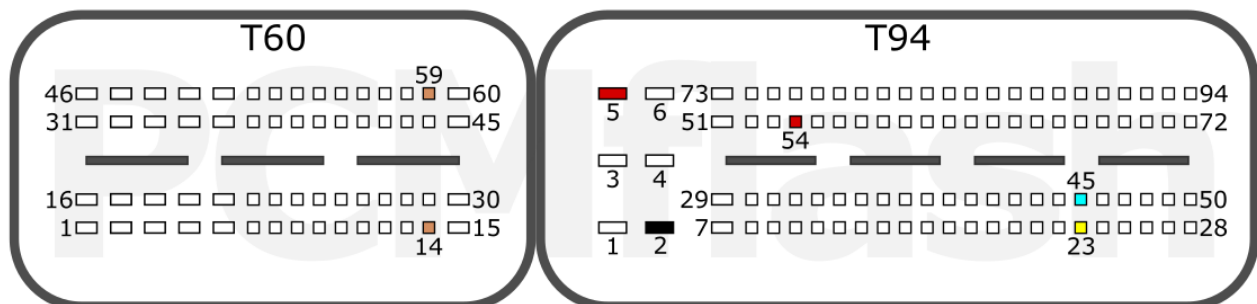

<b>+12V</b>	T94: 5, 54	<b>CAN-L</b>	T94: 45
<b>GND</b>	T94: 2	<b>CAN-H</b>	T94: 23
<b>GPT</b>	T60: 59, 14		

DODGE

JEEP

IVECO

MASERATI

pcmflash.ru

v.4

2023-03-23

# PCMflash

Engine Control Unit

## EDC17C81 TC1782

### Connection version 1

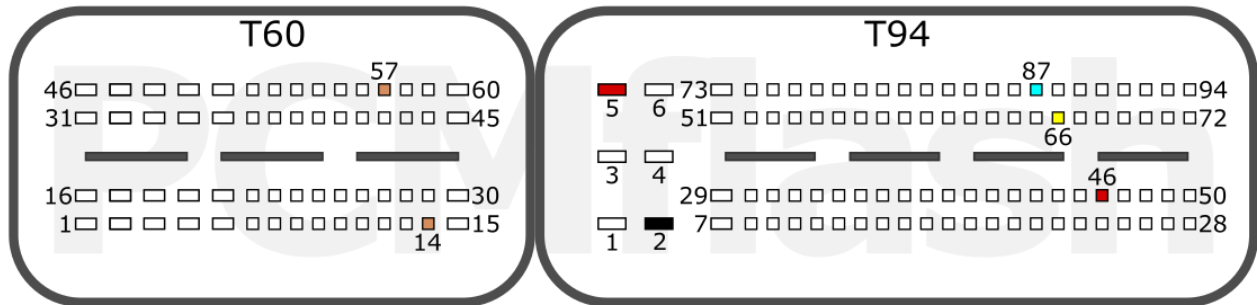

<b>+12V</b>	T94: 5, 46	<b>CAN-L</b>	T94: 87
<b>GND</b>	T94: 2	<b>CAN-H</b>	T94: 66
<b>GPT</b>	T60: 14, 57		

### Connection version 2

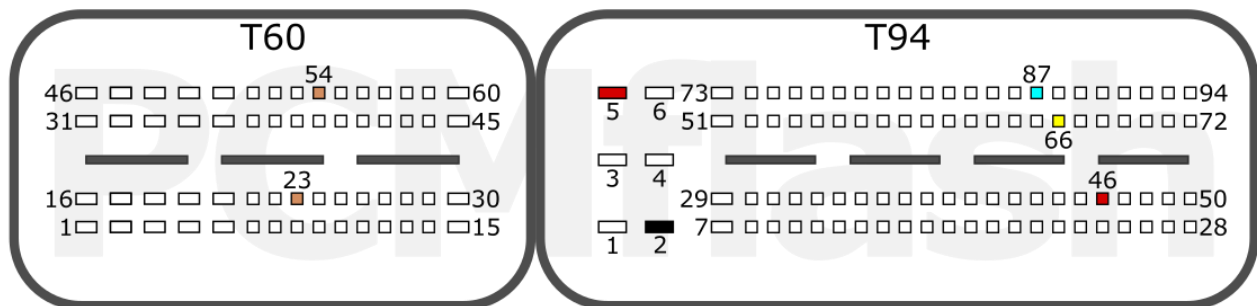

<b>+12V</b>	T94: 5, 46	<b>CAN-L</b>	T94: 87
<b>GND</b>	T94: 2	<b>CAN-H</b>	T94: 66
<b>GPT</b>	T60: 23, 54		

### Connection version 3

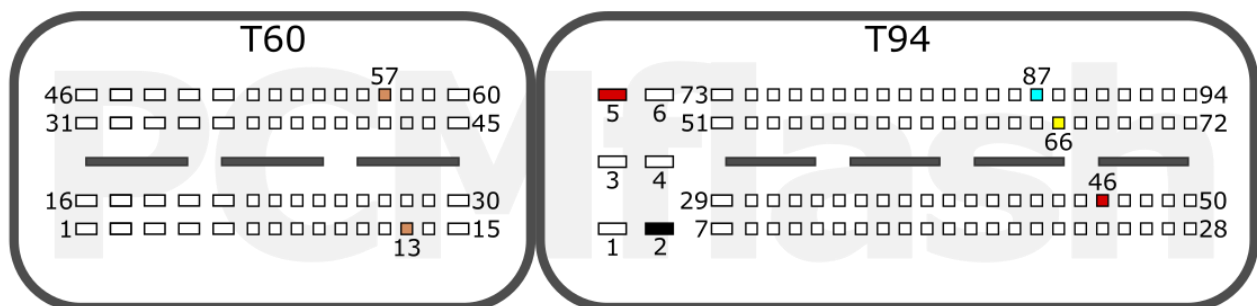

<b>+12V</b>	T94: 5, 46	<b>CAN-L</b>	T94: 87
<b>GND</b>	T94: 2	<b>CAN-H</b>	T94: 66
<b>GPT</b>	T60: 57, 13		

### TRUCKS

pcmflash.ru

v.3

2024-10-29

# PCMflash

Engine Control Unit

## EDC17C83 TC1793

T105

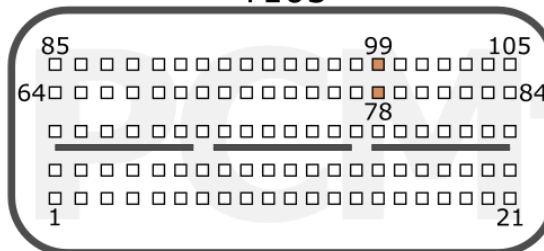

T91

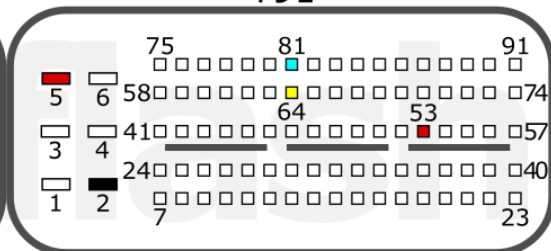

<b>+12V</b>	T91: 5, 53	<b>CAN-L</b>	T91: 81
<b>GND</b>	T91: 2	<b>CAN-H</b>	T91: 64
<b>GPT</b>	T105: 78, 99		

ISUZU

pcmflash.ru

v.1

2021-10-16

# PCMflash

Engine Control Unit

## EDC17C84 TC1782

### Connection version 1

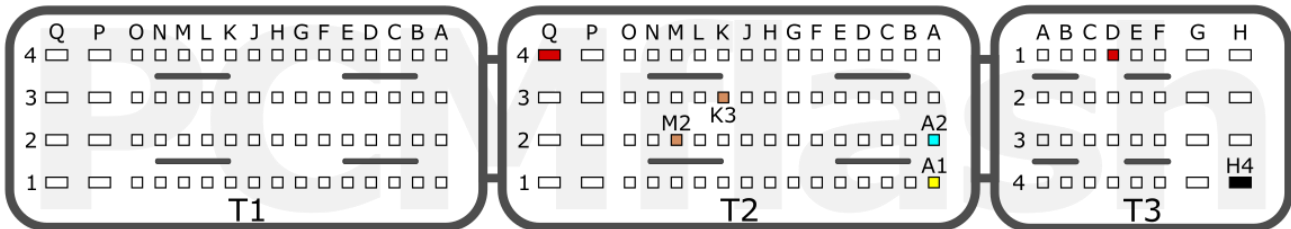

<b>+12V</b>	T2: Q4, T3: D1	<b>CAN-L</b>	T2: A2
<b>GND</b>	T3: H4	<b>CAN-H</b>	T2: A1
<b>GPT</b>	T2: M2, K3		

### Connection version 2

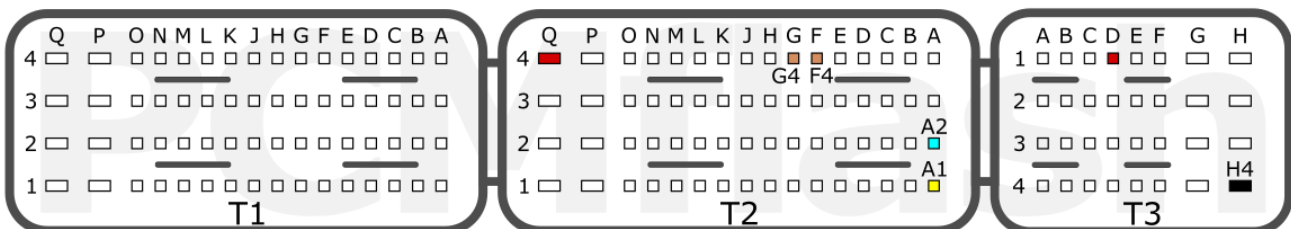

<b>+12V</b>	T2: Q4, T3: D1	<b>CAN-L</b>	T2: A2
<b>GND</b>	T3: H4	<b>CAN-H</b>	T2: A1
<b>GPT</b>	T2: F4, G4		

NISSAN

OPEL

RENAULT

pcmflash.ru

v.2

2024-06-07









# PCMflash

Engine Control Unit

EDC17CP05 TC1796/TC1797

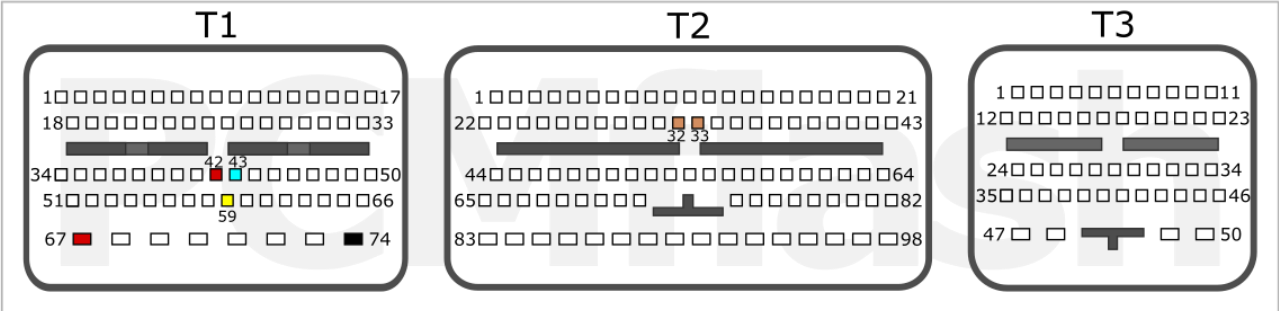

<b>+12V</b>	T1: 42, 67	<b>CAN-L</b>	T1: 43
<b>GND</b>	T1: 74	<b>CAN-H</b>	T1: 59
<b>GPT</b>	T2: 32, 33		

FORD

pcmflash.ru

v.2

2022-08-09



# PCMflash

Engine Control Unit

## EDC17CP07 TC1766

T1

T2

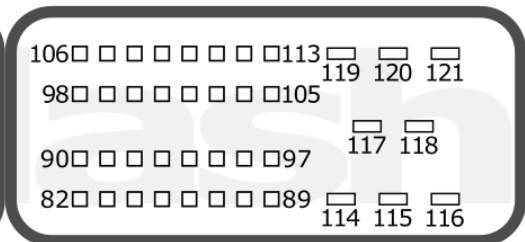
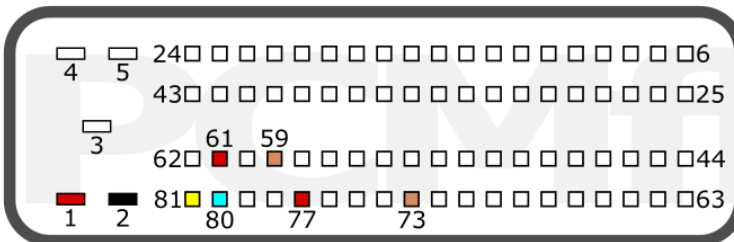

<b>+12V</b>	T1: 1, 61, 77	<b>CAN-L</b>	T1: 80
<b>GND</b>	T1: 2	<b>CAN-H</b>	T1: 81
<b>GPT</b>	T1: 59, 73		

TOYOTA

pcmflash.ru

v.1

2021-09-06

# PCMflash

Engine Control Unit

EDC17CP09 TC1796

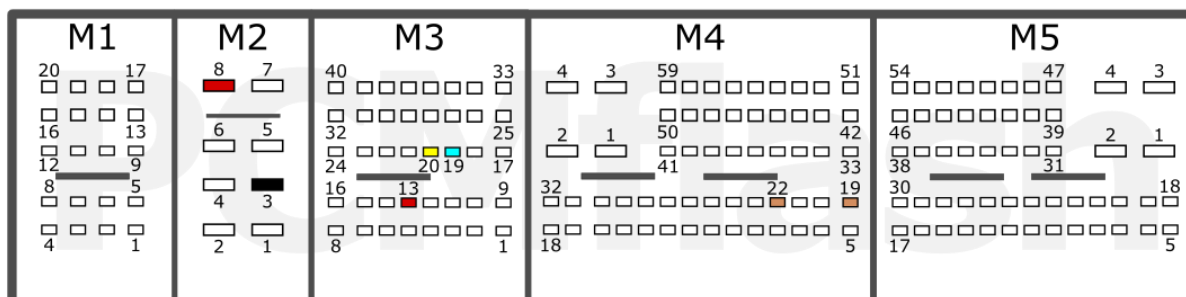

<b>+12V</b>	M2: 8, M3:13	<b>CAN-L</b>	M3: 19
<b>GND</b>	M2: 3	<b>CAN-H</b>	M3: 20
<b>GPT</b>	M4: 22, 19		

BMW

pcmflash.ru

v.1

2021-10-12

# PCMflash

Engine Control Unit

EDC17CP10 TC1796

T96

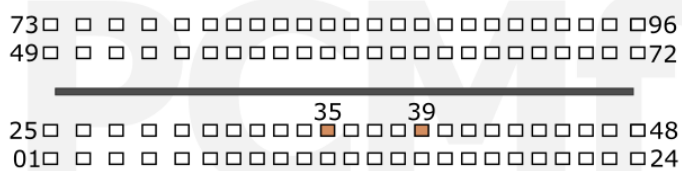

T58

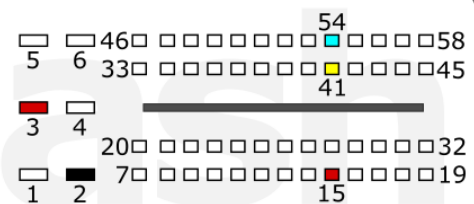

<b>+12V</b>	T58: 3, 15	<b>CAN-L</b>	T58: 54
<b>GND</b>	T58: 2	<b>CAN-H</b>	T58: 41
<b>GPT</b>	T96: 35, 39		

MB

pcmflash.ru

v.2

2024-05-29





# PCMflash

Engine Control Unit

EDC17CP14 TC1796

## Connection version 1

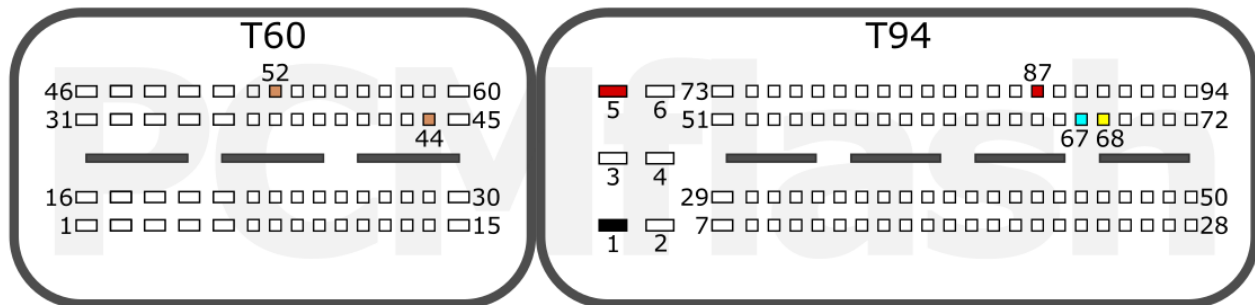

<b>+12V</b>	T94: 5, 87	<b>CAN-L</b>	T94: 67
<b>GND</b>	T94: 1	<b>CAN-H</b>	T94: 68
<b>GPT</b>	T60: 52, 44		

## Connection version 2

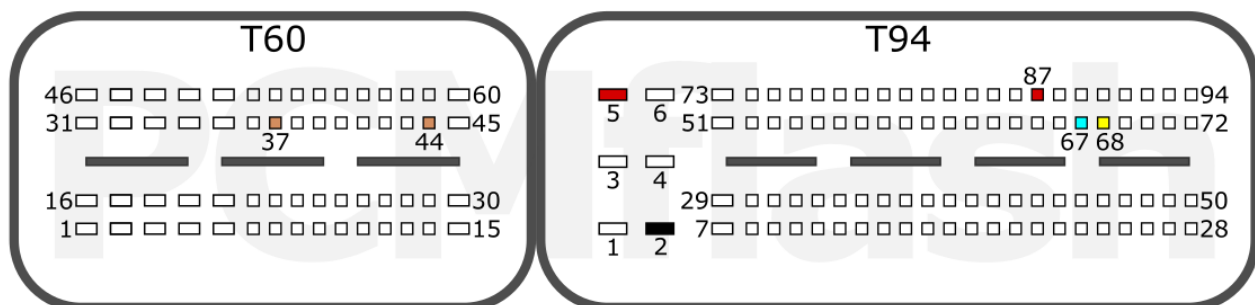

<b>+12V</b>	T94: 5, 87	<b>CAN-L</b>	T94: 67
<b>GND</b>	T94: 2	<b>CAN-H</b>	T94: 68
<b>GPT</b>	T60: 37, 44		

K/H

VAG

pcmflash.ru

v.1

2021-10-12



# PCMflash

Engine Control Unit

## EDC17CP16 TC1796

### Connection version 1

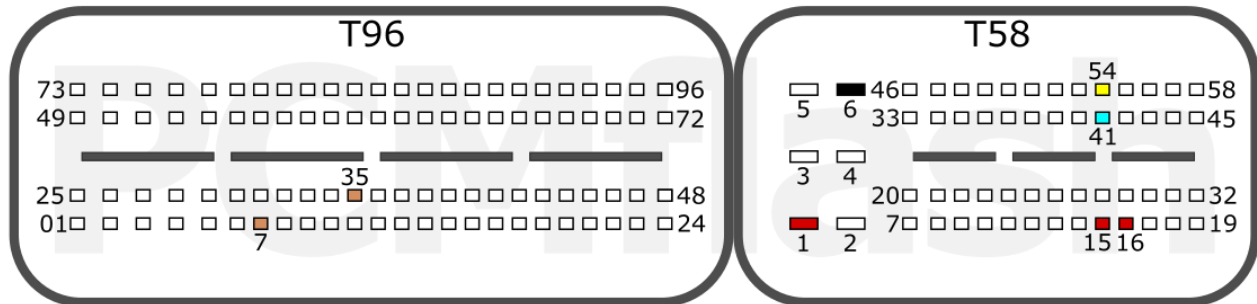

<b>+12V</b>	T58: 1, 15, 16	<b>CAN-L</b>	T58: 41
<b>GND</b>	T58: 6	<b>CAN-H</b>	T58: 54
<b>GPT</b>	T96: 7, 35		

### Connection version 2

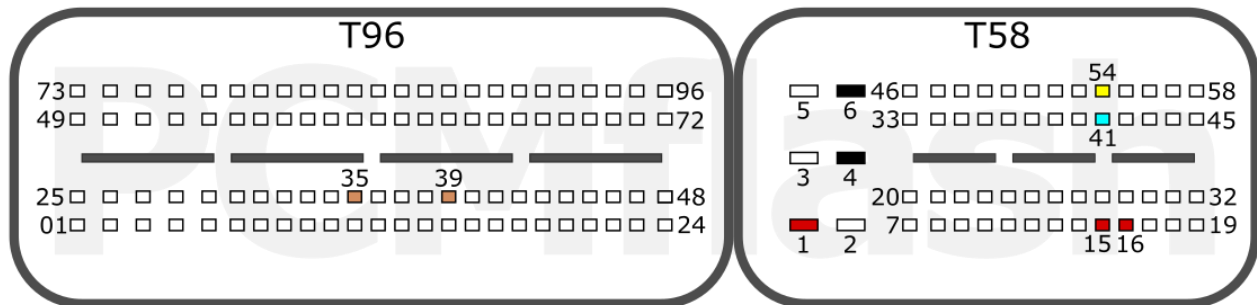

<b>+12V</b>	T58: 1, 15, 16	<b>CAN-L</b>	T58: 41
<b>GND</b>	T58: 4, 6	<b>CAN-H</b>	T58: 54
<b>GPT</b>	T96: 39, 35		

HONDA

pcmflash.ru

v.2

2021-02-28

# PCMflash

Engine Control Unit

## EDC17CP18 TC1796

J2

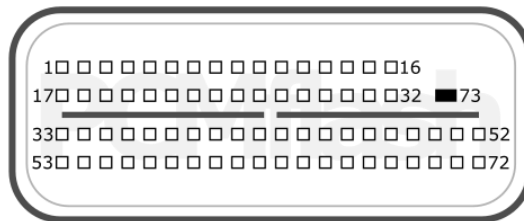

J1

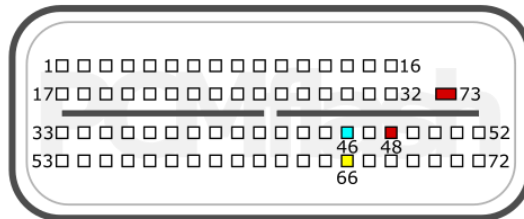

J3



<b>+12V</b>	J1: 73, 48	<b>CAN-L</b>	J1: 46
<b>GND</b>	J2: 73	<b>CAN-H</b>	J1: 66
<b>GPT</b>	J3: 61, 65		

GM

pcmflash.ru

v.1

2021-11-26

# PCMflash

Engine Control Unit

## EDC17CP19 TC1766

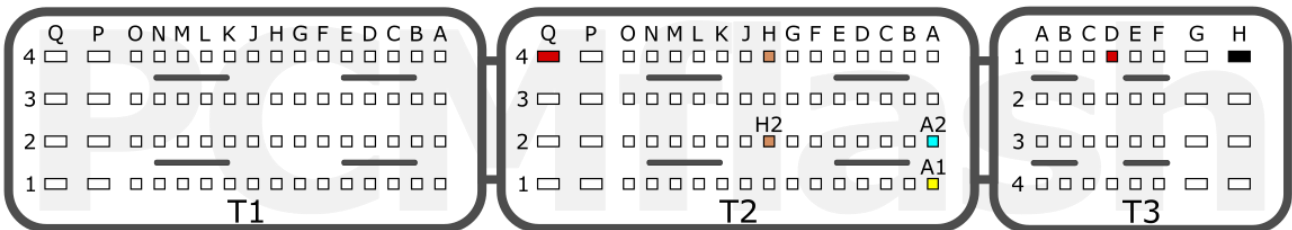

<b>+12V</b>	T2: Q4, T3:D1	<b>CAN-L</b>	T2: A2
<b>GND</b>	T3: H1	<b>CAN-H</b>	T2: A1
<b>GPT</b>	T2: H2, H4		

RENAULT

pcmflash.ru

v.2

2023-01-22





# PCMflash

Engine Control Unit

## EDC17CP22 TC1796

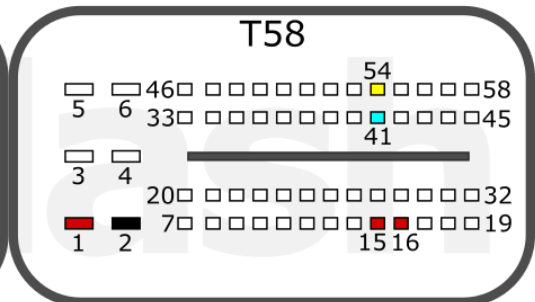

<b>+12V</b>	T58: 1, 15, 16	<b>CAN-L</b>	T58: 41
<b>GND</b>	T58: 2	<b>CAN-H</b>	T58: 54
<b>GPT</b>	T96: 35, 7		

VOLVO

pcmflash.ru

v.1

2021-09-09







# PCMflash

Engine Control Unit

## EDC17CP37 TC1766

### Connection version 1



<b>+12V</b>	T1: 4, 61, 77	<b>CAN-L</b>	T1: 80
<b>GND</b>	T1: 2	<b>CAN-H</b>	T1: 81
<b>GPT</b>	T2: 98, 106		

### Connection version 2



<b>+12V</b>	T1: 4, 61, 77	<b>CAN-L</b>	T1: 80
<b>GND</b>	T1: 2	<b>CAN-H</b>	T1: 81
<b>GPT</b>	T1: 59, 73		

TOYOTA

pcmflash.ru

v.2

2023-02-18

# PCMflash

Engine Control Unit

EDC17CP42 TC1797

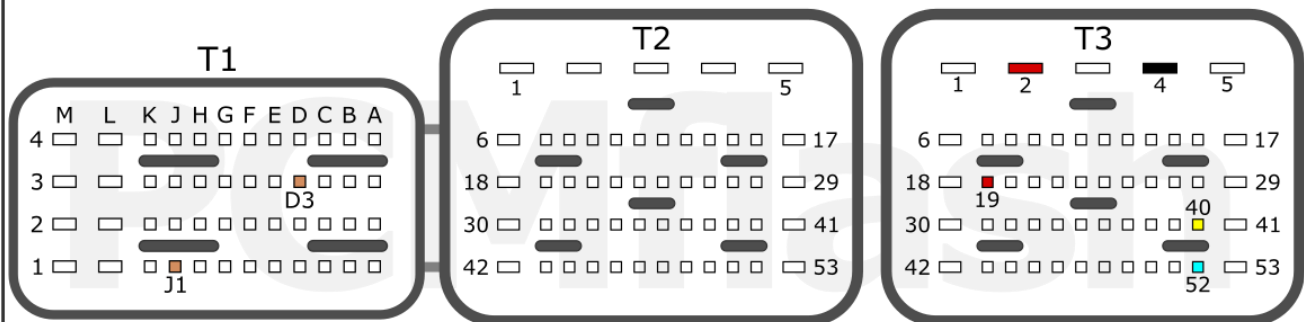

<b>+12V</b>	T3: 2, 19	<b>CAN-L</b>	T3: 52
<b>GND</b>	T3: 4	<b>CAN-H</b>	T3: 40
<b>GPT</b>	T1: D3, J1		

JLR

pcmflash.ru

v.1

2021-09-09

# PCMflash

Engine Control Unit

EDC17CP44 TC1797

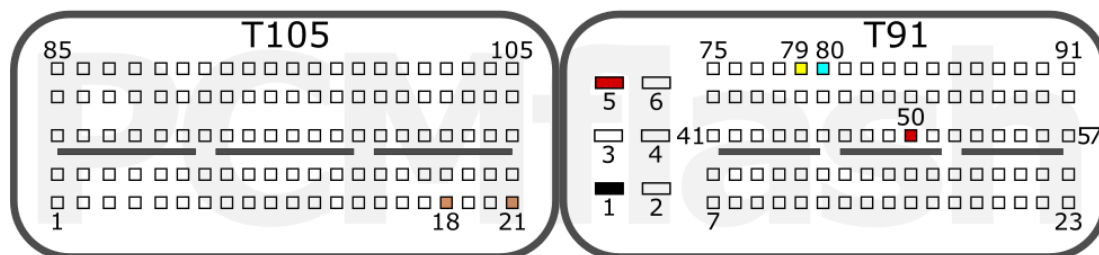

<b>+12V</b>	T91: 5, 50	<b>CAN-L</b>	T91: 80
<b>GND</b>	T91: 1	<b>CAN-H</b>	T91: 79
<b>GPT</b>	T105: 18, 21		

VAG

pcmflash.ru

v.1

2021-08-25

# PCMflash

Engine Control Unit

## EDC17CP45 TC1797

### DME8 E71

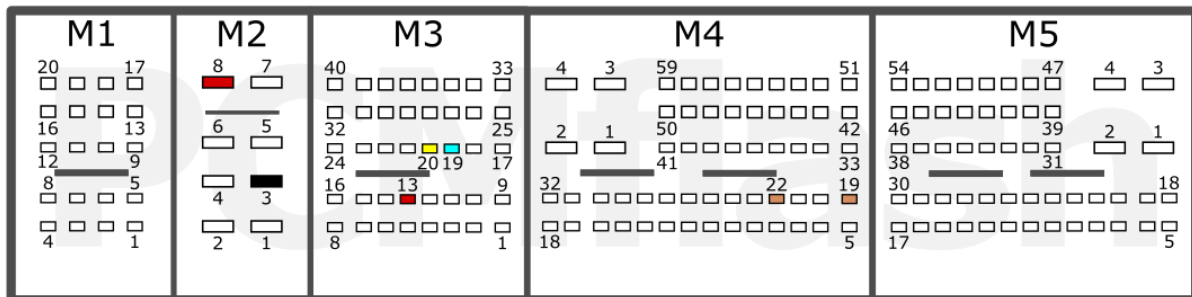

<b>+12V</b>	M2: 8, M3: 13	<b>CAN-L</b>	M3: 19
<b>GND</b>	M2: 3	<b>CAN-H</b>	M3: 20
<b>GPT</b>	M4: 22, 19		

### F10

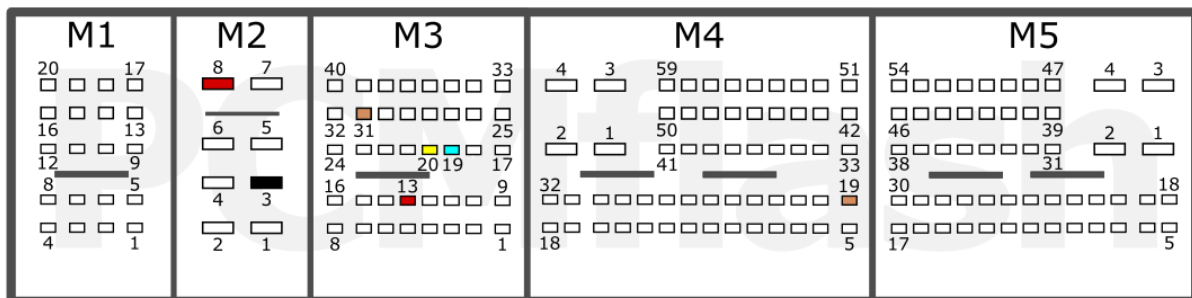

<b>+12V</b>	M2: 8, M3: 13	<b>CAN-L</b>	M3: 19
<b>GND</b>	M2: 3	<b>CAN-H</b>	M3: 20
<b>GPT</b>	M3: 31, M4: 19		

BMW

pcmflash.ru

v.1

2021-08-26













# PCMflash

Engine Control Unit

EDC17CP52 TC1797

## Connection version 1

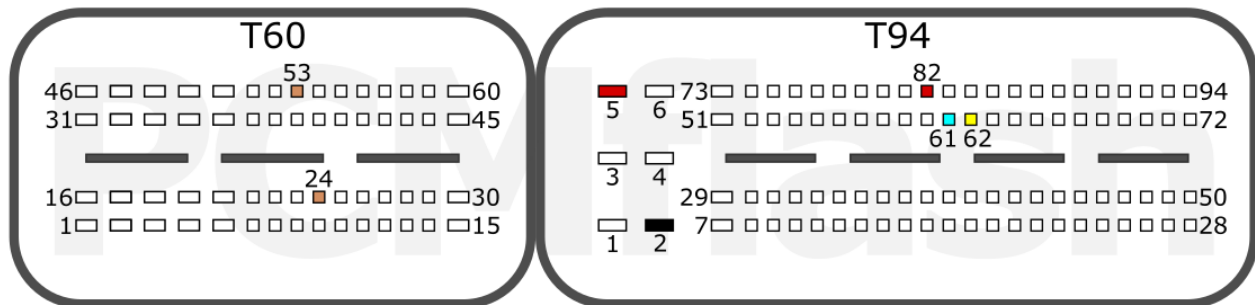

<b>+12V</b>	T94: 5, 82	<b>CAN-L</b>	T94: 61
<b>GND</b>	T94: 2	<b>CAN-H</b>	T94: 62
<b>GPT</b>	T60: 24, 53		

## Connection version 2

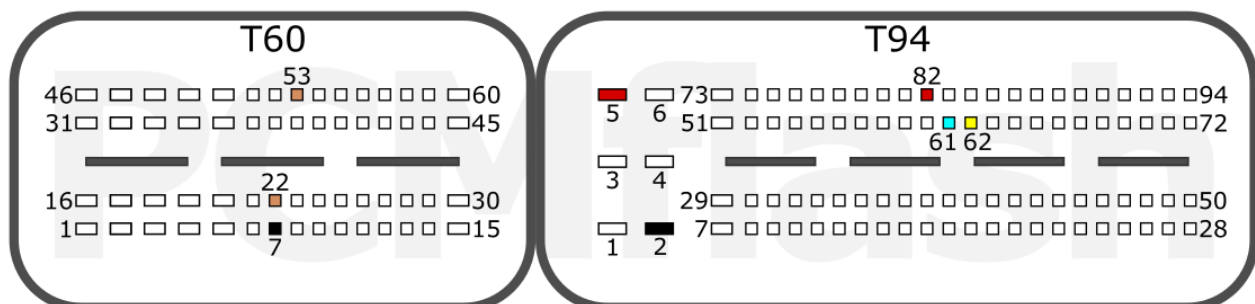

<b>+12V</b>	T94: 5, 82	<b>CAN-L</b>	T94: 61
<b>GND</b>	T60: 7, T94: 2	<b>CAN-H</b>	T94: 62
<b>GPT</b>	T60: 53, 22*		

\*10-47 uF 50v capacitor required on 22 GPT line /  
Подключить сигнал 22 GPT к ЭБУ через конденсатор 10-47 мкФ

FIAT

IVECO

MITSUBISHI

pcmflash.ru

v.3

2023-03-27

# PCMflash

Engine Control Unit

## EDC17CP54 TC1793

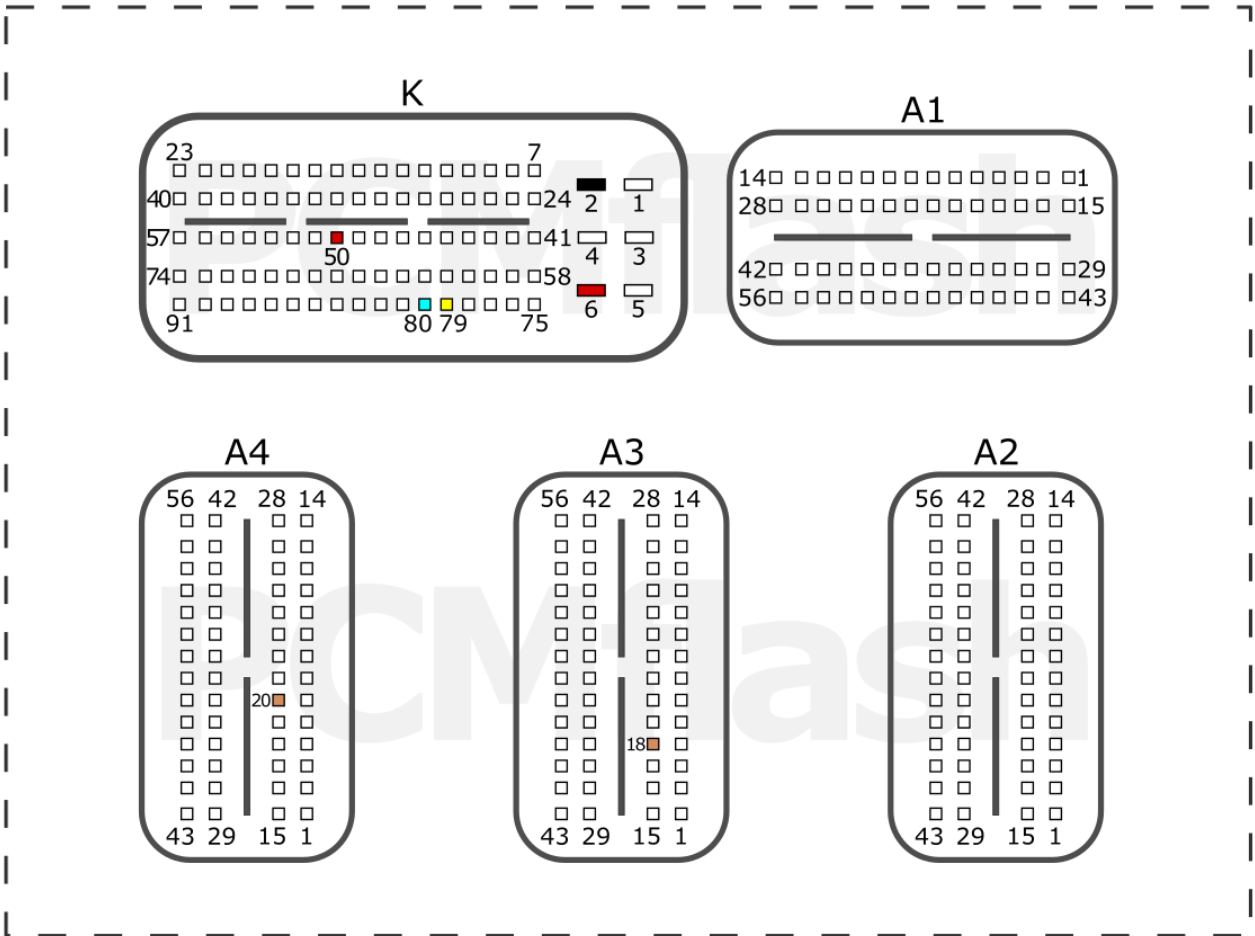

<b>+12V</b>	K: 6, 50	<b>CAN-L</b>	K: 80
<b>GND</b>	K: 2	<b>CAN-H</b>	K: 79
<b>GPT</b>	A3: 18, A4: 20		

AMAROK

pcmflash.ru

v.1

2022-12-21

# PCMflash

Engine Control Unit

## EDC17CP54 TC1793

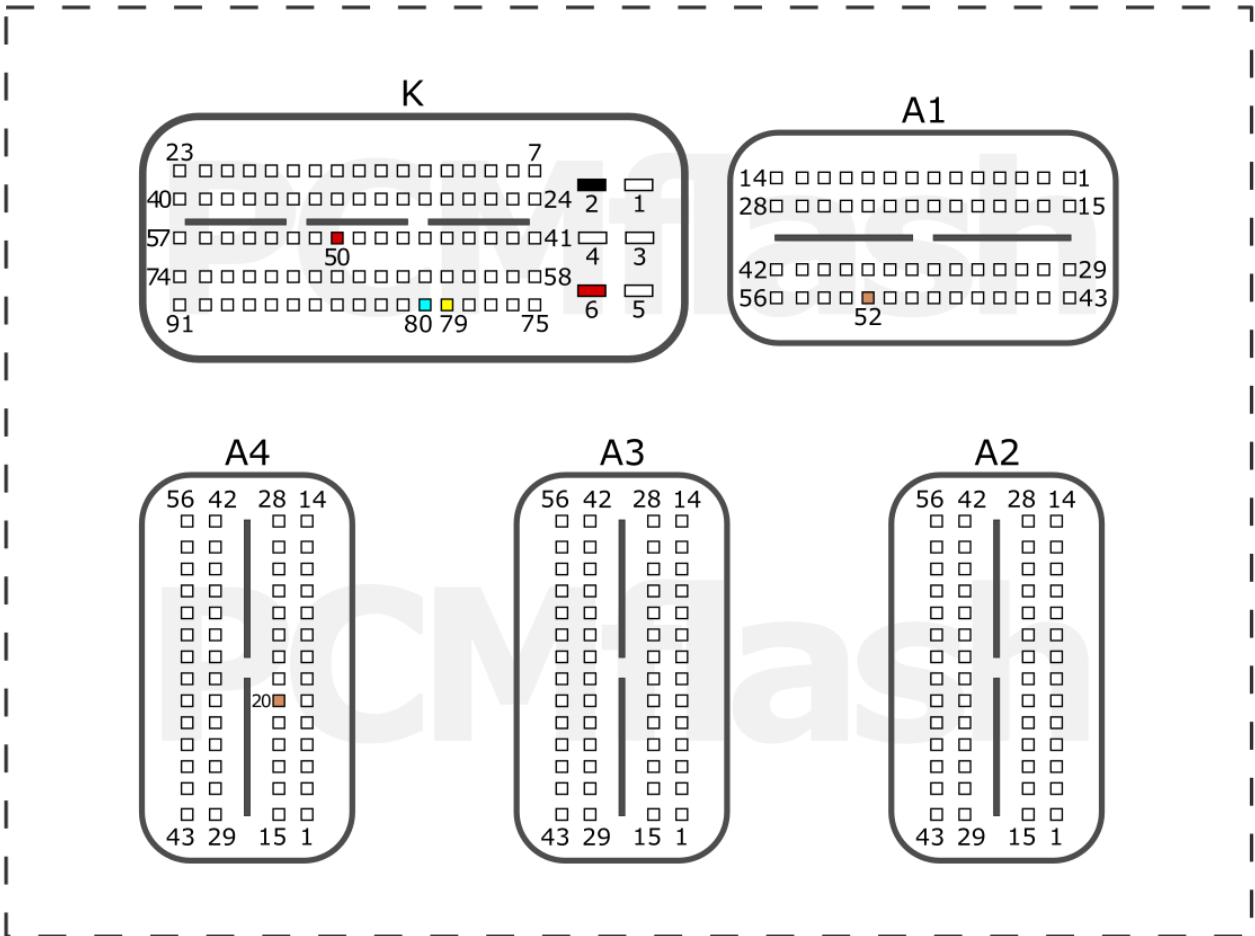

<b>+12V</b>	K: 6, 50	<b>CAN-L</b>	K: 80
<b>GND</b>	K: 2	<b>CAN-H</b>	K: 79
<b>GPT</b>	A4: 20, A1: 52		

AUDI

pcmflash.ru

v.1

2021-10-09

# PCMflash

Engine Control Unit

EDC17CP55 TC1793

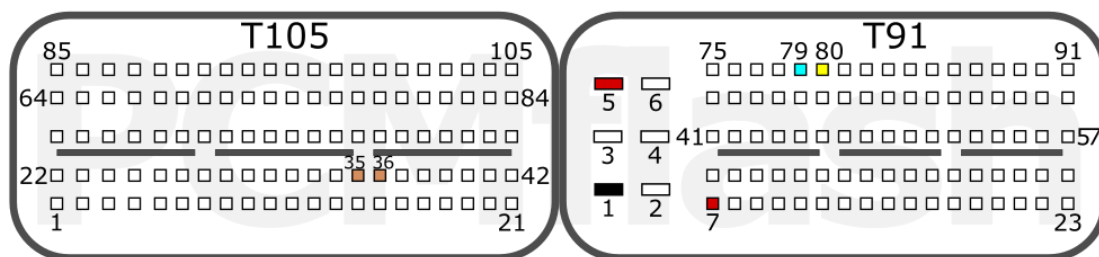

<b>+12V</b>	T91: 5, 7	<b>CAN-L</b>	T91: 79
<b>GND</b>	T91: 1	<b>CAN-H</b>	T91: 80
<b>GPT</b>	T105: 35, 36		

LAND ROVER

pcmflash.ru

v.2

2022-06-08

# PCMflash

Engine Control Unit

## EDC17CP57 TC1793

### Connection version 1

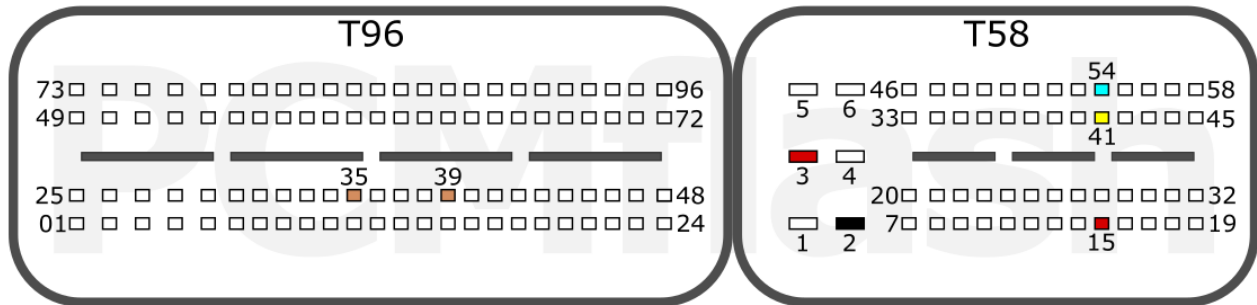

<b>+12V</b>	T58: 3, 15	<b>CAN-L</b>	T58: 54
<b>GND</b>	T58: 2	<b>CAN-H</b>	T58: 41
<b>GPT</b>	T96: 35, 39		

### Connection version 2

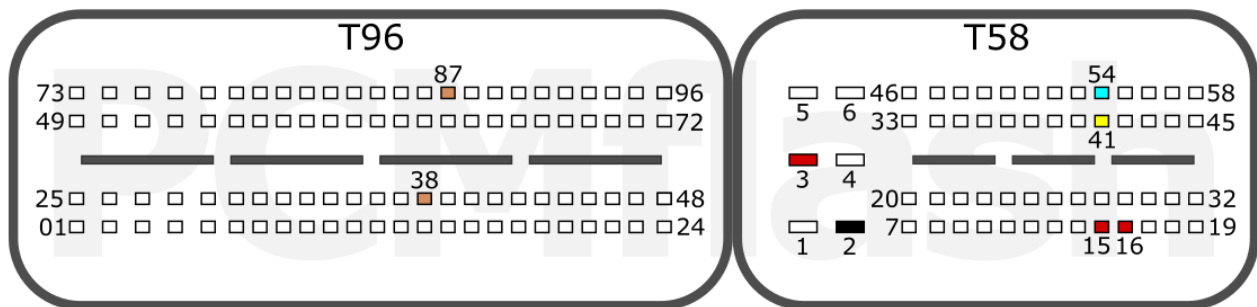

<b>+12V</b>	T58: 3, 15, 16	<b>CAN-L</b>	T58: 54
<b>GND</b>	T58: 2	<b>CAN-H</b>	T58: 41
<b>GPT</b>	T96: 87, 38		

MB

pcmflash.ru

v.1

2021-10-11



# PCMflash

Engine Control Unit

EDC17CP58 TC1767

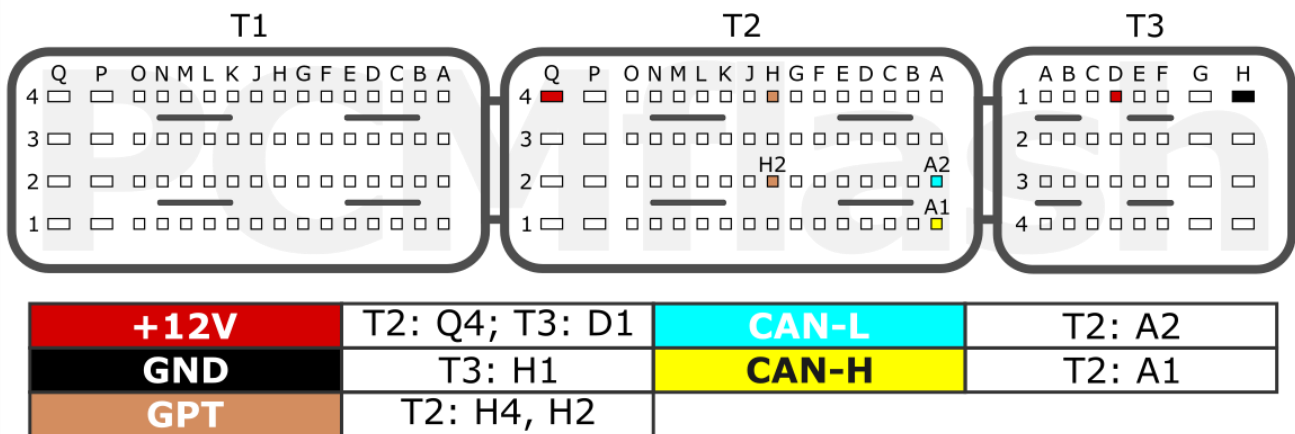

RENAULT

pcmflash.ru

v.1

2023-09-10

# PCMflash

Engine Control Unit

EDC17CP60 TC1793

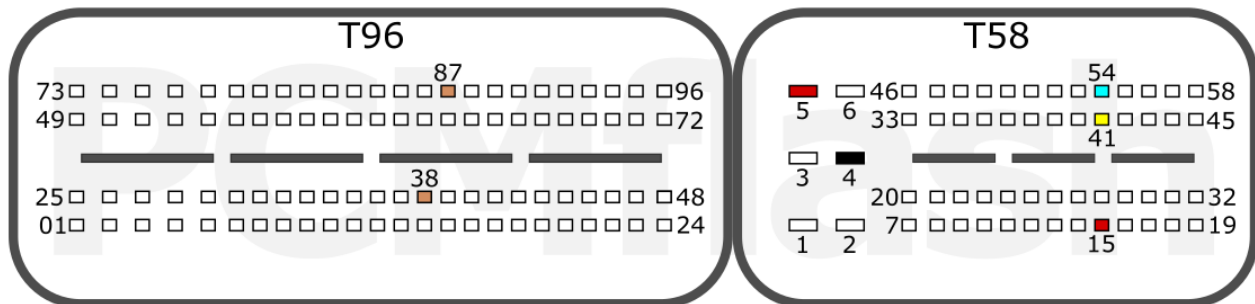

<b>+12V</b>	T58: 5, 15	<b>CAN-L</b>	T58: 54
<b>GND</b>	T58: 4	<b>CAN-H</b>	T58: 41
<b>GPT</b>	T96: 87, 38		

MB

pcmflash.ru

v.1

2023-05-21

# PCMflash

Engine Control Unit

EDC17CP62 TC1793

T105

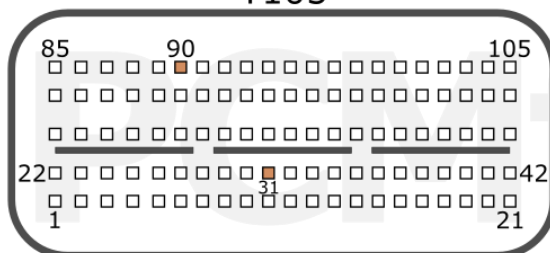

T91

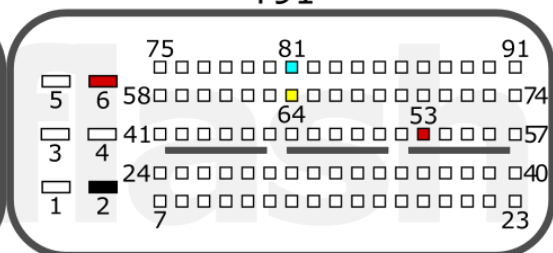

<b>+12V</b>	T91: 6, 53	<b>CAN-L</b>	T91: 81
<b>GND</b>	T91: 2	<b>CAN-H</b>	T91: 64
<b>GPT</b>	T105: 31, 90		

K/H

pcmflash.ru

v.1

2022-02-03

# PCMflash

Engine Control Unit

EDC17CP65 TC1793

T1

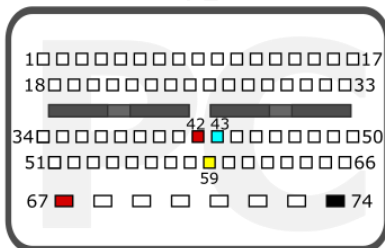

T2

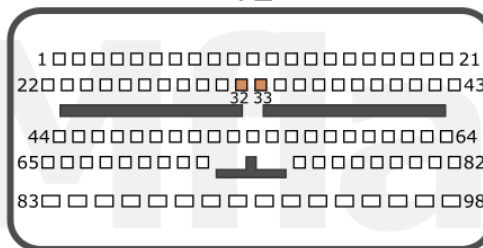

T3

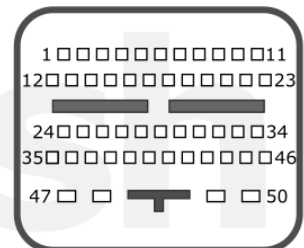

<b>+12V</b>	T1: 42, 67	<b>CAN-L</b>	T1: 43
<b>GND</b>	T1: 74	<b>CAN-H</b>	T1: 59
<b>GPT</b>	T2: 32, 33		

FORD

pcmflash.ru

v.2

2022-08-09



# PCMflash

Engine Control Unit

EDC17CP74 TC1793

T105

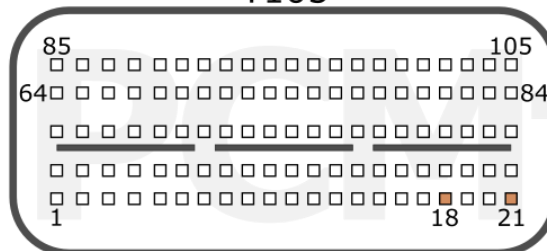

T91

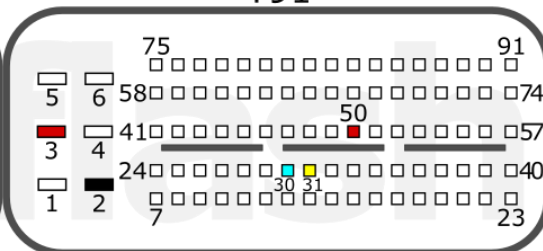

<b>+12V</b>	T91: 3, 50	<b>CAN-L</b>	T91: 30
<b>GND</b>	T91: 2	<b>CAN-H</b>	T91: 31
<b>GPT</b>	T105: 21, 18		

VAG

pcmflash.ru

v.1

2022-01-24

# PCMflash

Engine Control Unit

## EDC17CV41 TC1797

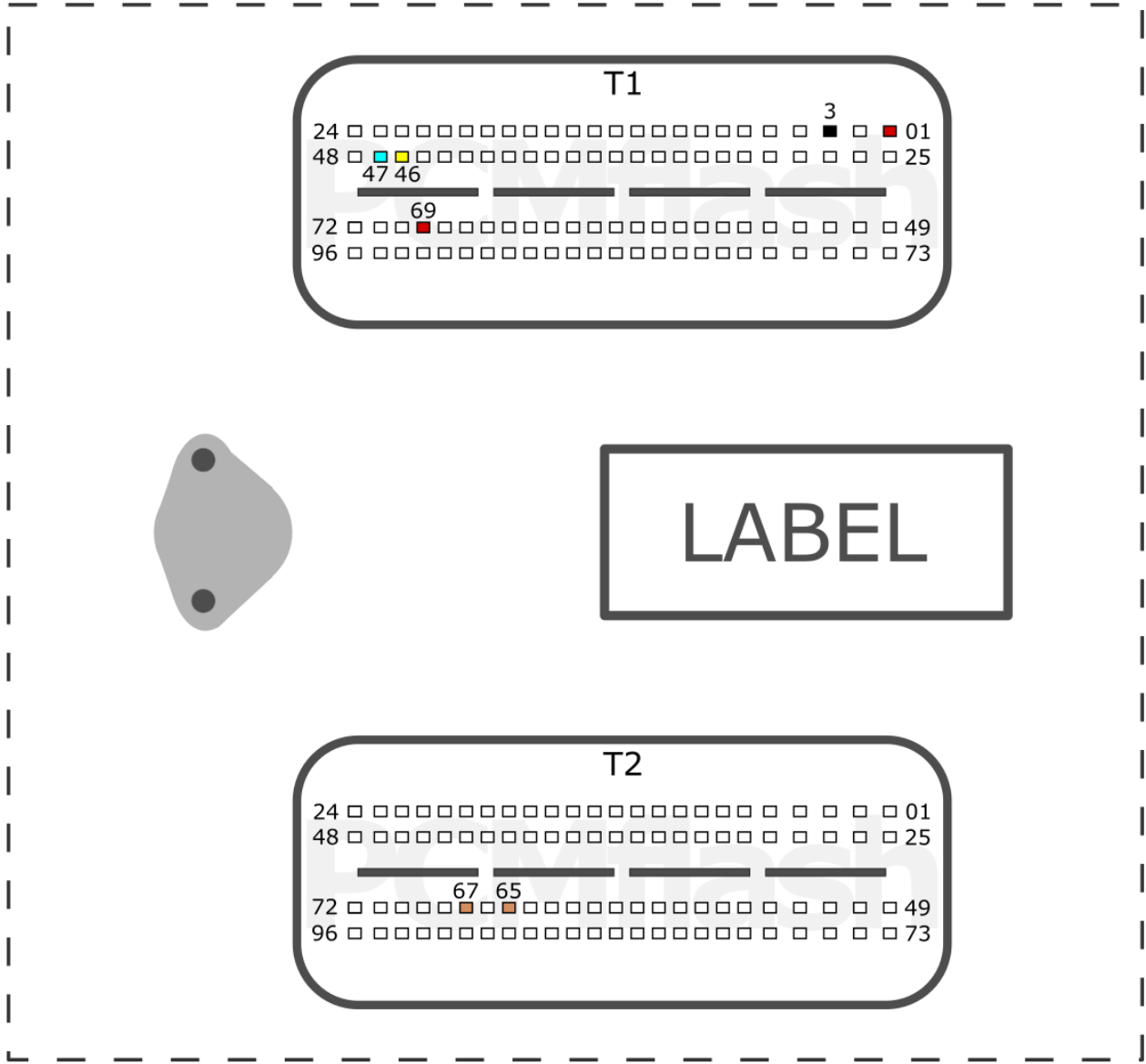

<b>+12V</b>	T1: 1, 69	<b>CAN-L</b>	T1: 47
<b>GND</b>	T1: 3	<b>CAN-H</b>	T1: 46
<b>GPT</b>	T2: 67, 65		

See next page/смотри следующую страницу

COMMERCIAL

# PCMflash

Engine Control Unit

## EDC17CV41 TC1797

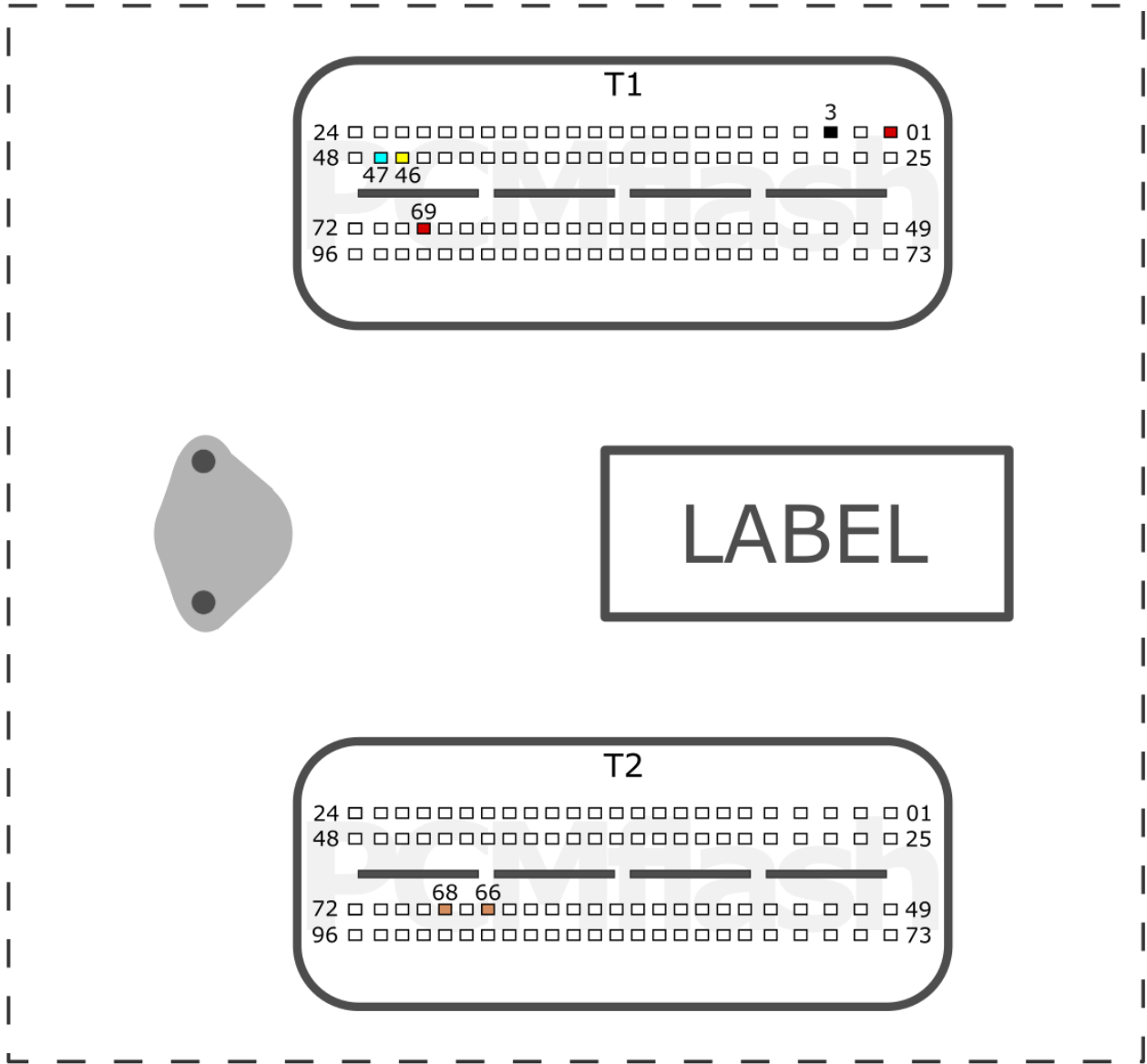

<b>+12V</b>	T1: 1, 69	<b>CAN-L</b>	T1: 47
<b>GND</b>	T1: 3	<b>CAN-H</b>	T1: 46
<b>GPT</b>	T2: 66, 68		

COMMERCIAL

pcmflash.ru

v.1

2023-04-22



# PCMflash

Engine Control Unit

## EDC17CV42 TC1797

### Connection version 1

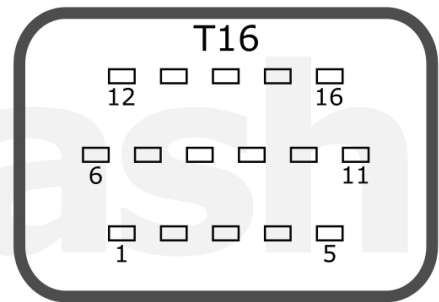
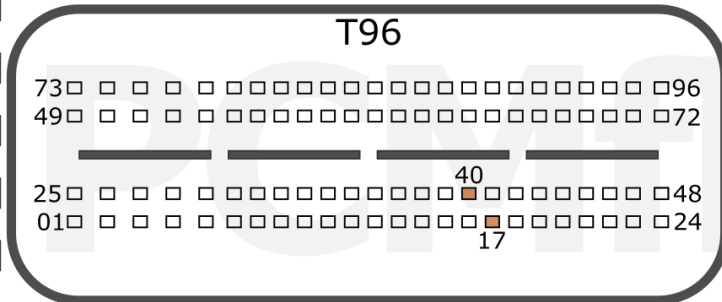

LABEL

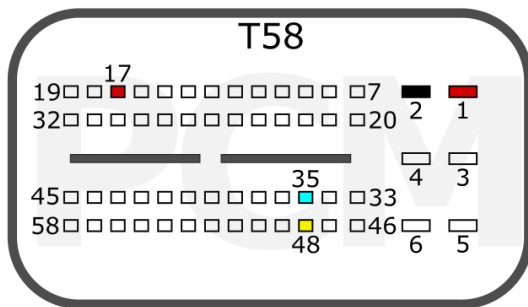

<b>+12V</b>	T58: 17, 1	<b>CAN-L</b>	T58: 35
<b>GND</b>	T58: 2	<b>CAN-H</b>	T58: 48
<b>GPT</b>	T96: 17, 40		

MAN

pcmflash.ru

v.2

2025-01-24

# PCMflash

Engine Control Unit

## EDC17CV42 TC1797

### Connection version 2

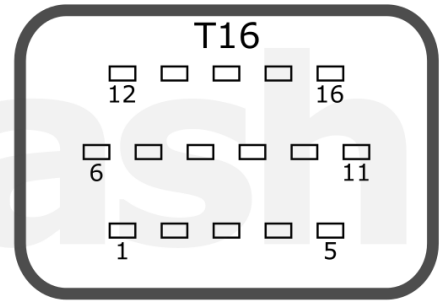
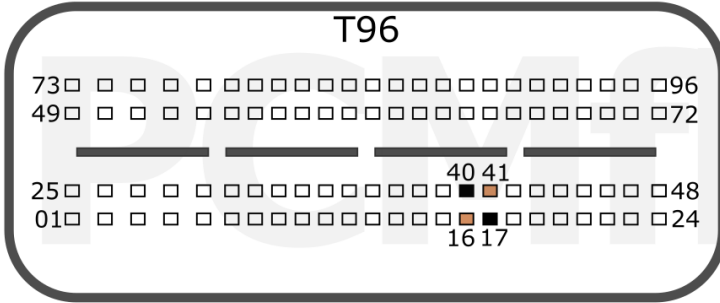

LABEL

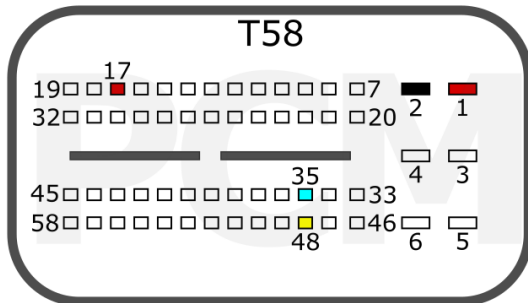

<b>+12V</b>	T58: 17, 1	<b>CAN-L</b>	T58: 35
<b>GND</b>	T96:40, 17; T58: 2	<b>CAN-H</b>	T58: 48
<b>GPT*</b>	T96: 16, 41		

\*Install 10-50 uF capacitors on each GPT line/  
Установите конденсаторы 10-50 мкФ на каждую GPT линию

MAN

pcmflash.ru

v.2

2025-01-24

# PCMflash

Engine Control Unit

## EDC17CV43/CV44 TC1767

### Connection version 1

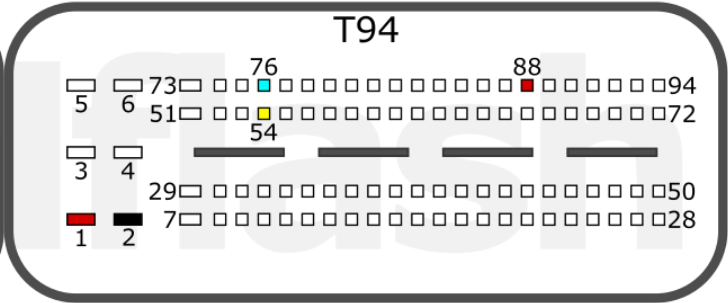
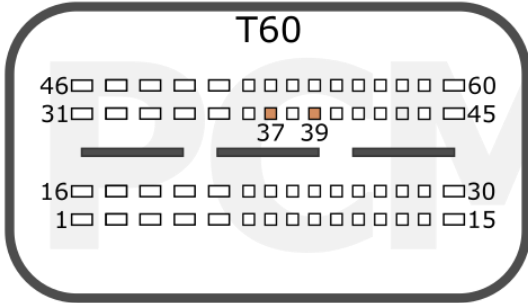

<b>+12V</b>	T94: 1, 88	<b>CAN-L</b>	T94: 76
<b>GND</b>	T94: 2	<b>CAN-H</b>	T94: 54
<b>GPT</b>	T60: 37, 39		

### Connection version 2

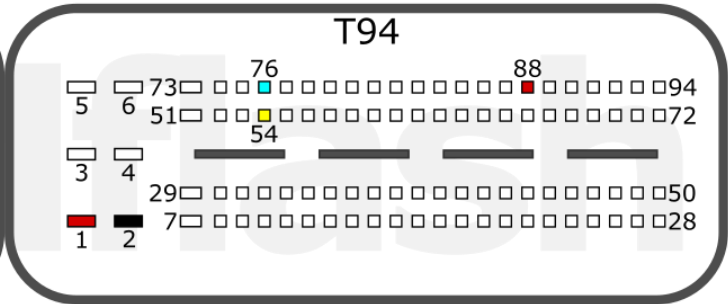
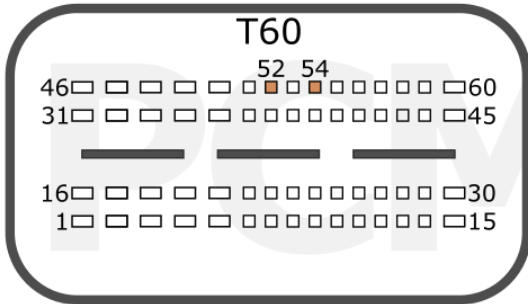

<b>+12V</b>	T94: 1, 88	<b>CAN-L</b>	T94: 76
<b>GND</b>	T94: 2	<b>CAN-H</b>	T94: 54
<b>GPT</b>	T60: 52, 54		

### Connection version 3

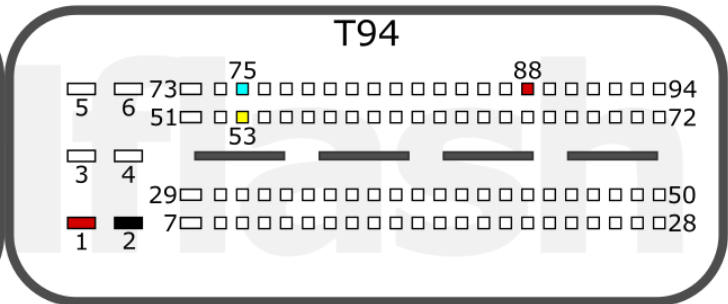
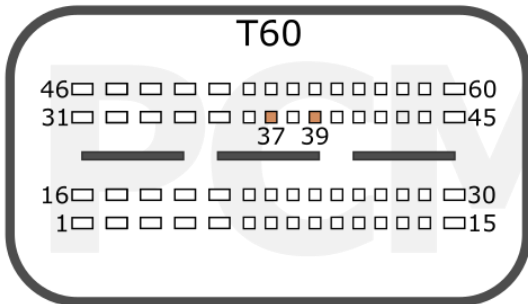

<b>+12V</b>	T94: 1, 88	<b>CAN-L</b>	T94: 75
<b>GND</b>	T94: 2	<b>CAN-H</b>	T94: 53
<b>GPT</b>	T60: 37, 39		

FAW

pcmflash.ru

v.4

2025-02-12

# PCMflash

Engine Control Unit

## EDC17CV45 TC1782

LABEL

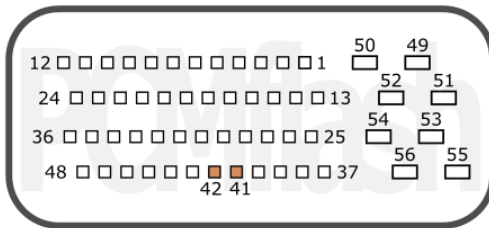

T1

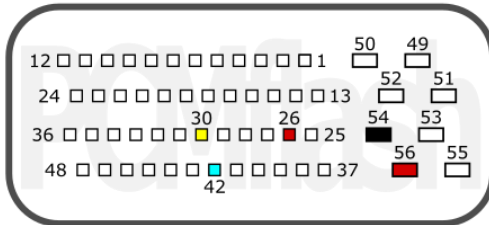

T2

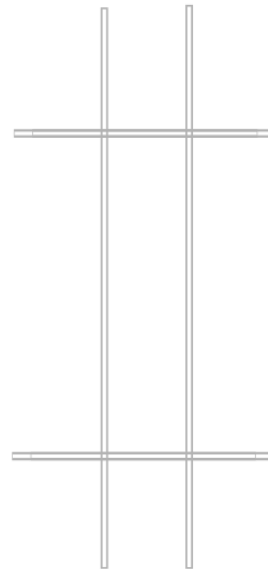

<b>+12V</b>	T2: 26, 56	<b>CAN-L</b>	T2: 42
<b>GND</b>	T2: 54	<b>CAN-H</b>	T2: 30
<b>GPT</b>	T1: 41, 42		

KUBOTA

pcmflash.ru

v.1

2024-05-27

# PCMflash

Engine Control Unit

## EDC17CV52 TC1797

T105

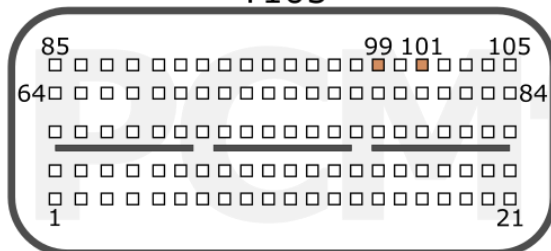

T91

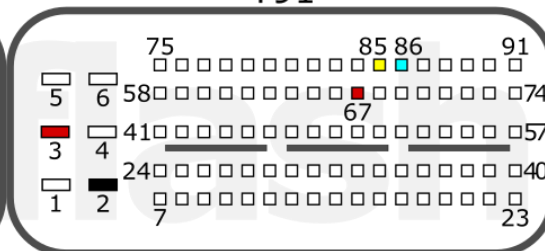

<b>+12V</b>	T91: 3, 67	<b>CAN-L</b>	T91: 86
<b>GND</b>	T91: 2	<b>CAN-H</b>	T91: 85
<b>GPT</b>	T105: 99, 101		

DEUTZ

pcmflash.ru

v.1

2021-10-12

# PCMflash

Engine Control Unit

EDC17CV53/CV54/CV56 TC1767

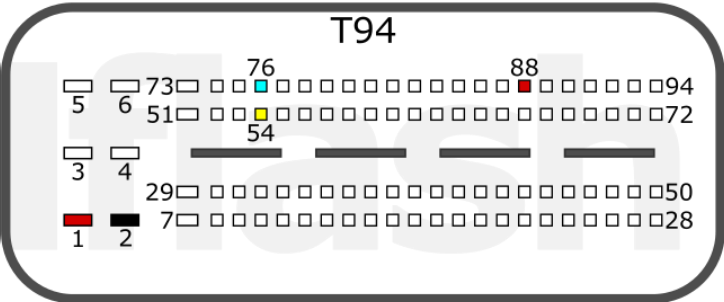
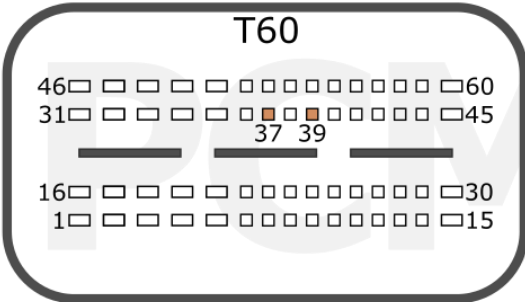

<b>+12V</b>	T94: 1, 88	<b>CAN-L</b>	T94: 76
<b>GND</b>	T94: 2	<b>CAN-H</b>	T94: 54
<b>GPT</b>	T60: 37, 39		

DEUTZ

FOTON

PAZ

pcmflash.ru

v.2

2022-05-23







# PCMflash

AdBlue Control Unit

## DCU17CV51 TC1724

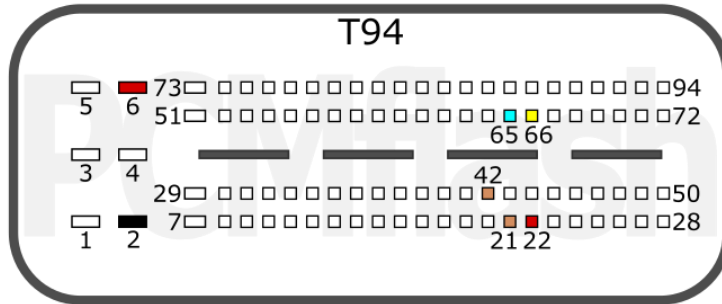

<b>+12V</b>	6, 22	<b>CAN-L</b>	65
<b>GND</b>	2	<b>CAN-H</b>	66
<b>GPT</b>	21, 42		

ALL

pcmflash.ru

v.1

2024-04-18

# PCMflash

AdBlue Control Unit

## DCU17HD01 TC1766

T86

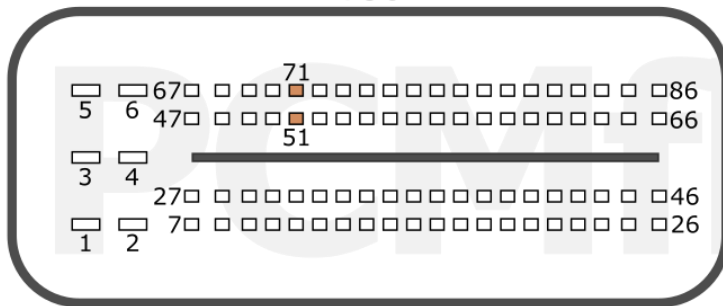

T53

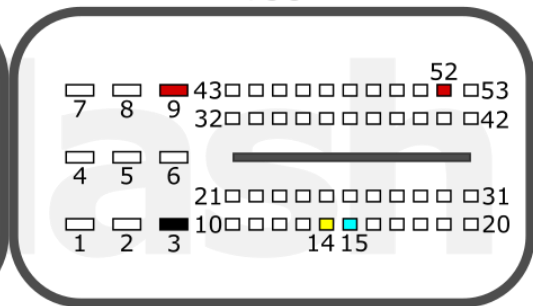

<b>+12V</b>	T53: 9, 52	<b>CAN-L</b>	T53: 15
<b>GND</b>	T53: 3	<b>CAN-H</b>	T53: 14
<b>GPT</b>	T86: 71, 51		

HINO

pcmflash.ru

v.2

2024-04-18

# PCMflash

AdBlue Control Unit

## DCU17PC01 TC1766

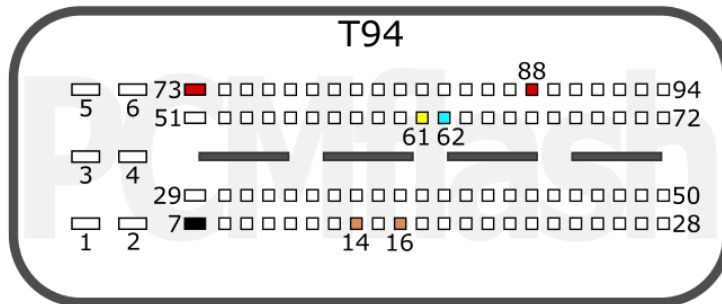

<b>+12V</b>	73, 88	<b>CAN-L</b>	62
<b>GND</b>	7	<b>CAN-H</b>	61
<b>GPT</b>	14, 16		

FORD

MB

pcmflash.ru

v.2

2024-04-18

# PCMflash

AdBlue Control Unit

## DCU17PC42/PC43 TC1724

### Connection version 1

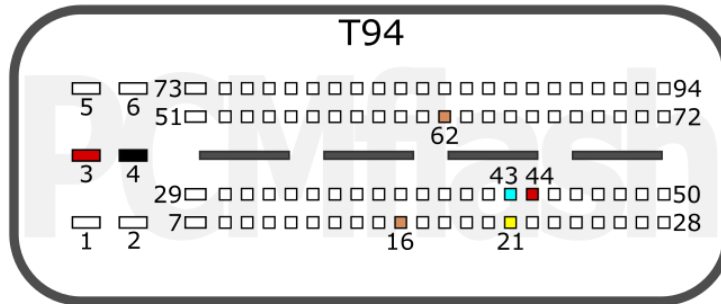

<b>+12V</b>	3, 44	<b>CAN-L</b>	43
<b>GND</b>	4	<b>CAN-H</b>	21
<b>GPT</b>	16, 62		

### Connection version 2

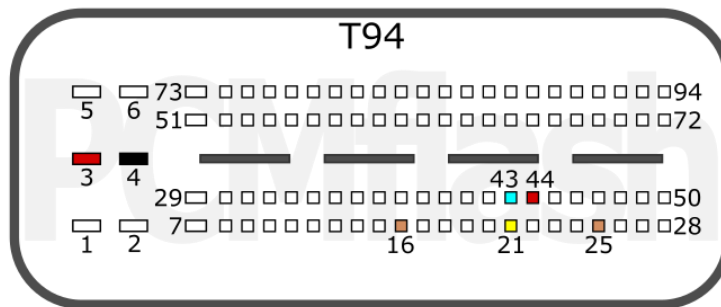

<b>+12V</b>	3, 44	<b>CAN-L</b>	43
<b>GND</b>	4	<b>CAN-H</b>	21
<b>GPT</b>	16, 25		

### Connection version 3

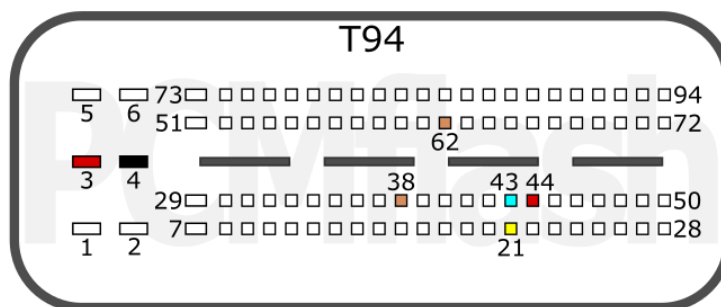

<b>+12V</b>	3, 44	<b>CAN-L</b>	43
<b>GND</b>	4	<b>CAN-H</b>	21
<b>GPT</b>	38, 62		