

PCMflash module 80

Denso SH725XX/1N83M

Contents/Оглавление

Contents/Оглавление.....	2
DAIHATSU/TOYOTA SH72531	3
FAW SH72530	4
HINO/KIA/HYUNDAI TRUCK E6 (SH725xx/1N83M)	5
HINO300 EURO5/EURO6 1N83M	6
HINO AdBlue 1N83M.....	7
HYUNDAI PETROL SH72530	8
HYUNDAI/KUBOTA SH7254x	9
KUBOTA AdBlue SH72531	10
MAZDA DIESEL SH725xx.....	11
MAZDA PETROL SH725xx.....	12
MAZDA GEN 4 1N83N	13
MAZDA TCM.....	14
MAZDA TCM.....	14
MITSUBISHI/SUBARU SH72543	15
NISSAN SH72530/SH72531	16
SUBARU SH72531	17
SUBARU 1.6L, 2.0L, 2.5L DI 1N83M	18
SUZUKI SH72530/72533.....	19
SUZUKI 1N83M	20
VOLVO SH7254x	21

PCMflash

Engine Control Unit

SH72531

TYPE 1

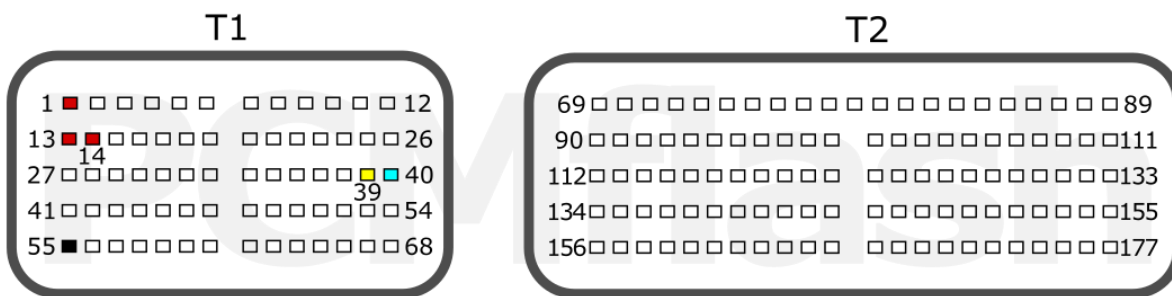

+12V	T1: 1, 13, 14	CAN-L	T1: 40
GND	T1: 55	CAN-H	T1: 39

TYPE 2

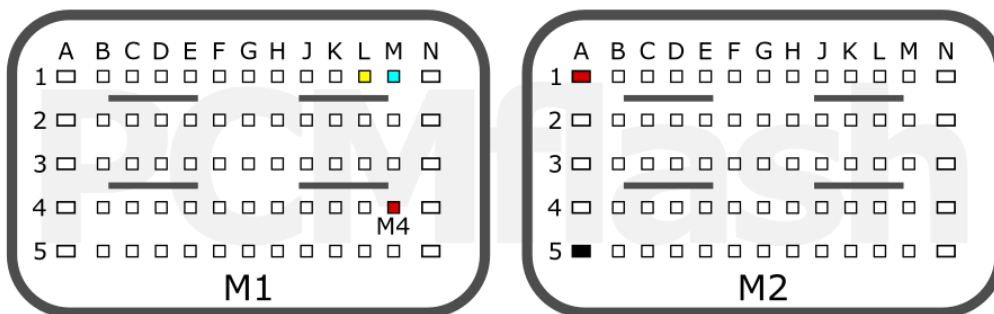

+12V	M1: M4; M2: A1	CAN-L	M1: M1
GND	M2: A5	CAN-H	M1: L1

DAIHATSU

TOYOTA

pcmflash.ru

v.2

2022-11-01

PCMflash

Engine Control Unit

SH72530

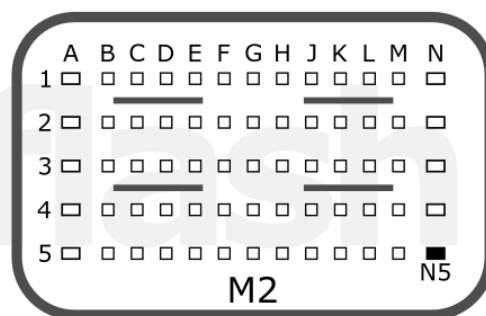
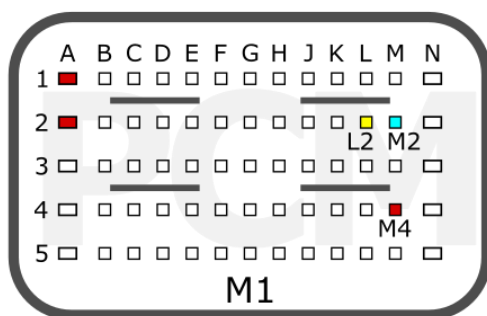

+12V	M1: A1, A2, M4	CAN-L	M1: M2
GND	M2: N5	CAN-H	M1: L2

FAW

pcmflash.ru

v.1

2021-09-13

PCMflash

Engine Control Unit

DENSO TRUCK E6 (SH725xx/1N83M)

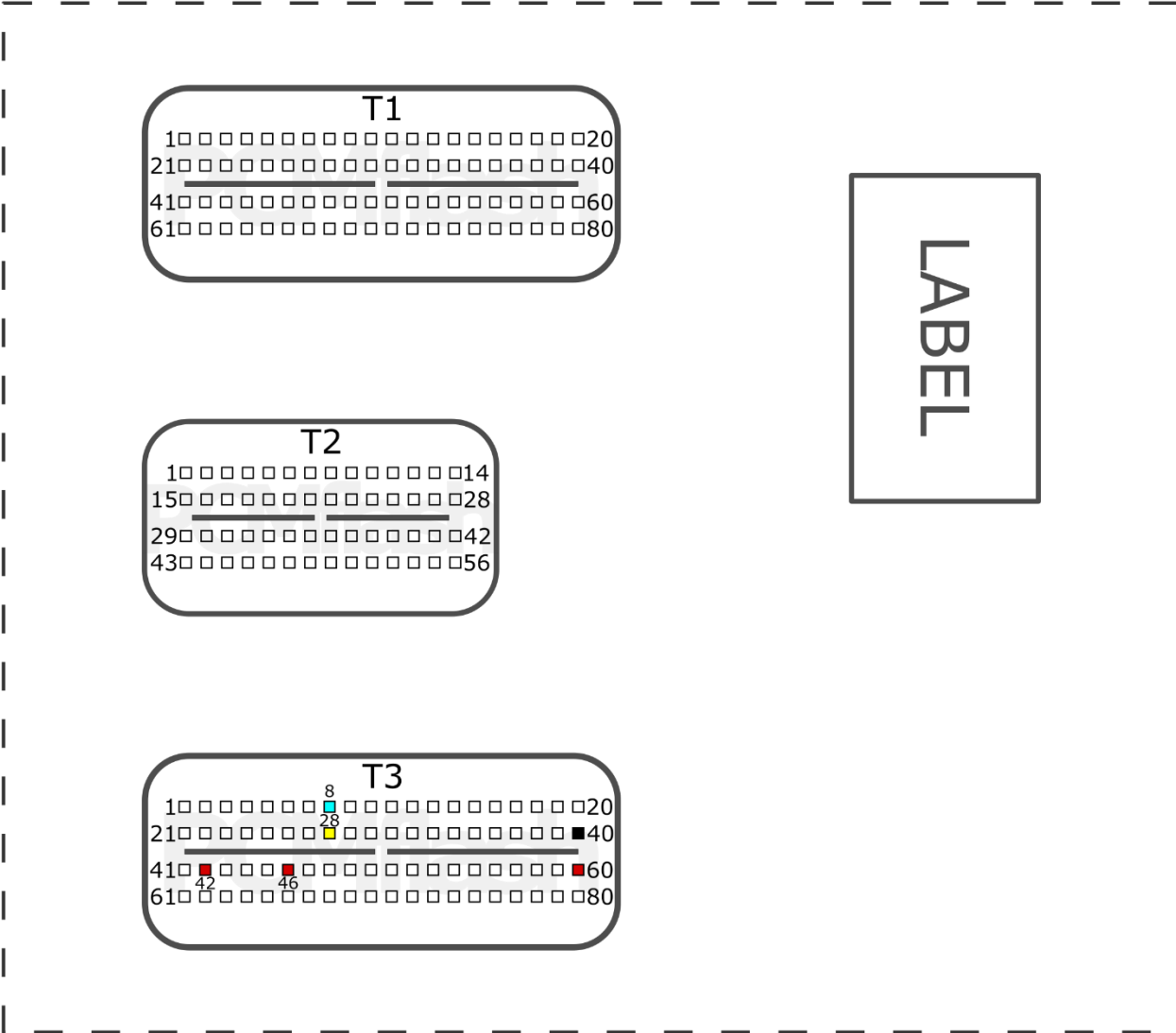

+12V	T3: 42, 46, 60	CAN-L	T3: 8
GND	T3: 40	CAN-H	T3: 28

HINO

KIA

HYUNDAI

pcmflash.ru

v.3

2024-03-29

PCMflash

Engine Control Unit

1N83M

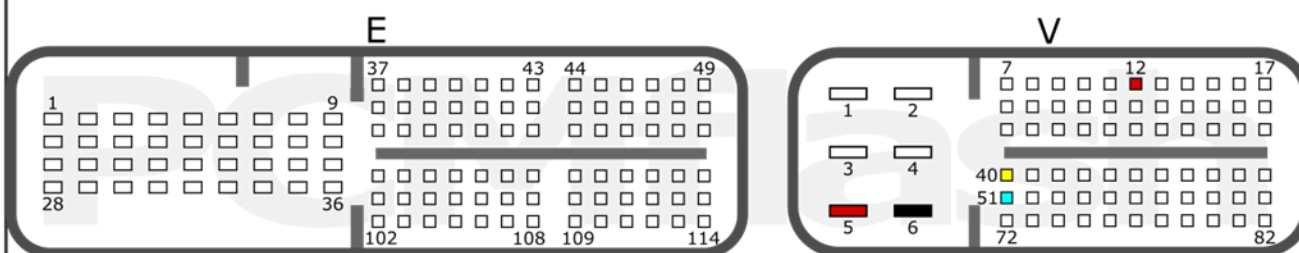

+12V	V: 5, 12	CAN-L	V: 51
GND	V: 6	CAN-H	V: 40

HINO 300 EURO 5/EURO 6

pcmflash.ru

v.1

2022-08-03

PCMflash

AdBlue Control Unit

1N83M

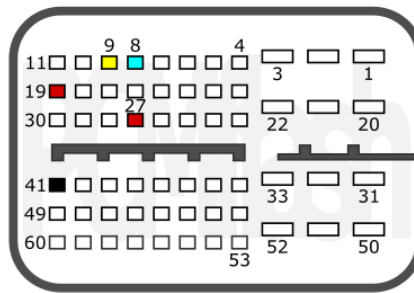

+12V	19, 27	CAN-L	8
GND	41	CAN-H	9

HINO AdBlue

pcmflash.ru

v.1

2024-03-30

PCMflash

Engine Control Unit

SH72530

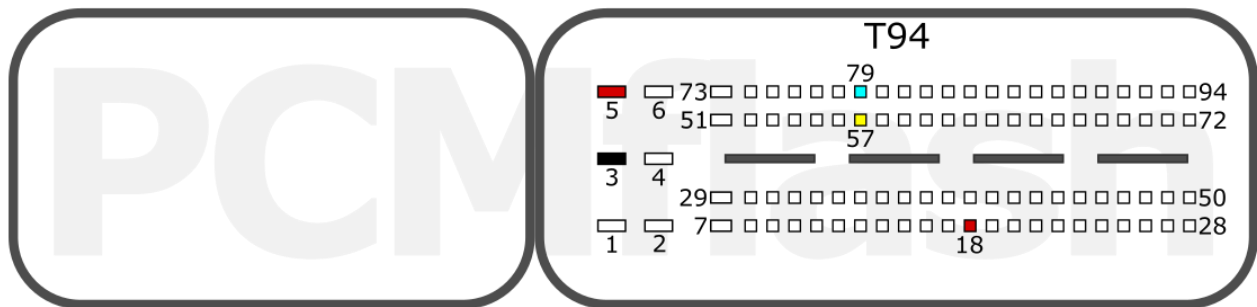

+12V	T94: 5, 18	CAN-L	T94: 79
GND	T94: 3	CAN-H	T94: 57

HYUNDAI PETROL

pcmflash.ru

v.2

2023-04-08

PCMflash

Engine Control Unit

DENSO SH7254x

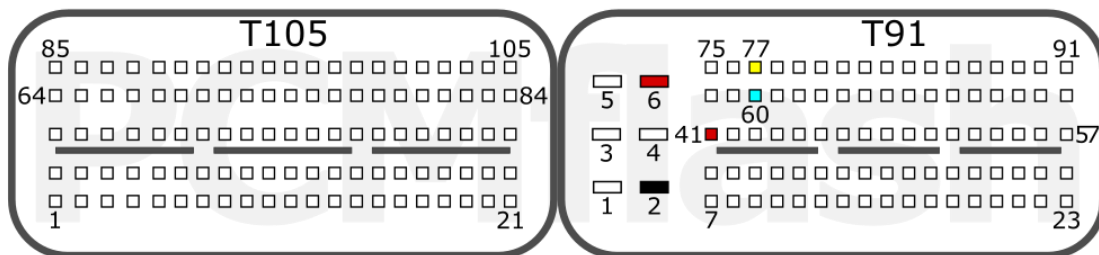

+12V	T91: 6, 41	CAN-L	T91: 60
GND	T91: 2	CAN-H	T91: 77

HYUNDAI

KUBOTA

pcmflash.ru

v.2

2022-07-16

PCMflash

AdBlue Control Unit

SH72531

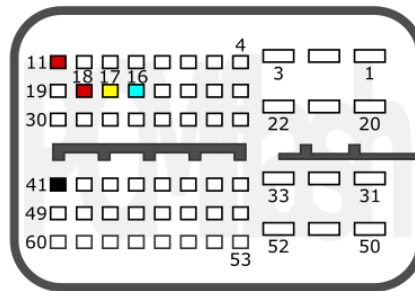

+12V	11, 18	CAN-L	16
GND	41	CAN-H	17

KUBOTA AdBlue

pcmflash.ru

v.2

2024-03-30

PCMflash

Engine Control Unit

SH725xx

SKYACTIV-D (SH72543)

A

B

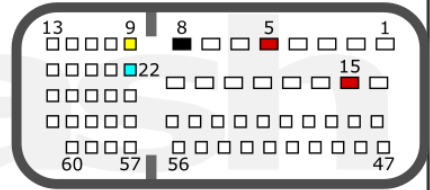
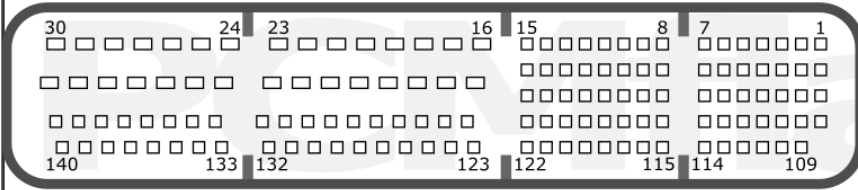

+12V	B: 5, 15	CAN-L	B: 22
GND	B: 8	CAN-H	B: 9

SKYACTIV-D S5 (SH72546)

A

B

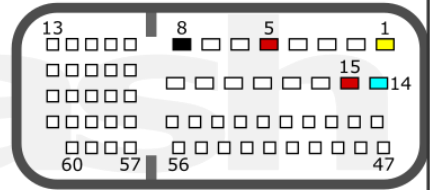
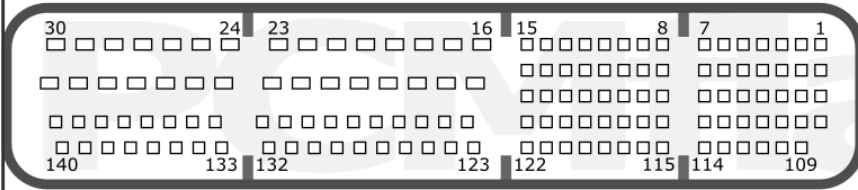

+12V	B: 5, 15	CAN-L	B: 14
GND	B: 8	CAN-H	B: 1

MAZDA DIESEL

pcmflash.ru

v.4

2022-08-03

PCMflash

Engine Control Unit

SH725xx

SKYACTIV-G (SH72543)

A

B

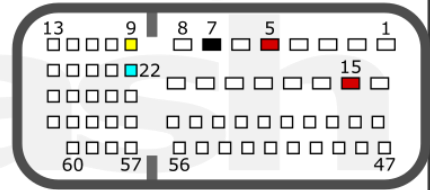
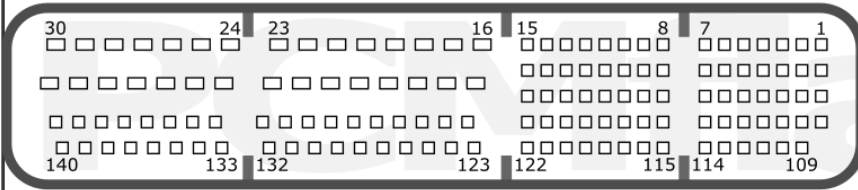

+12V	B: 5, 15	CAN-L	B: 22
GND	B: 7	CAN-H	B: 9

SH72531

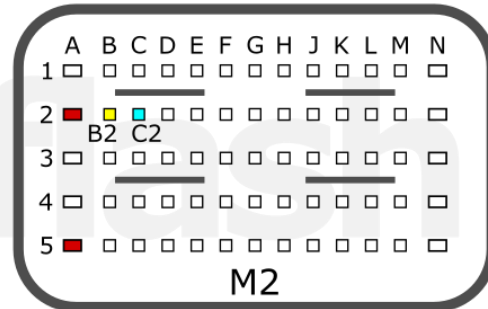
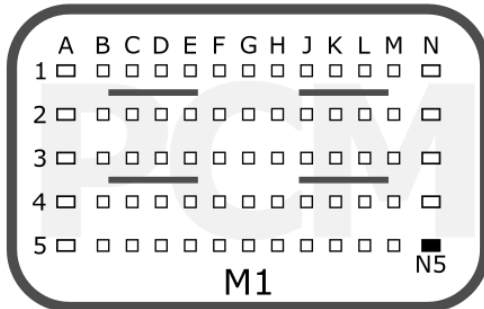

+12V	M2: A2, A5	CAN-L	M2: C2
GND	M1: N5	CAN-H	M2: B2

MAZDA PETROL

pcmflash.ru

v.3

2022-07-24

PCMflash

Engine Control Unit

1N83M

SKYACTIV-G

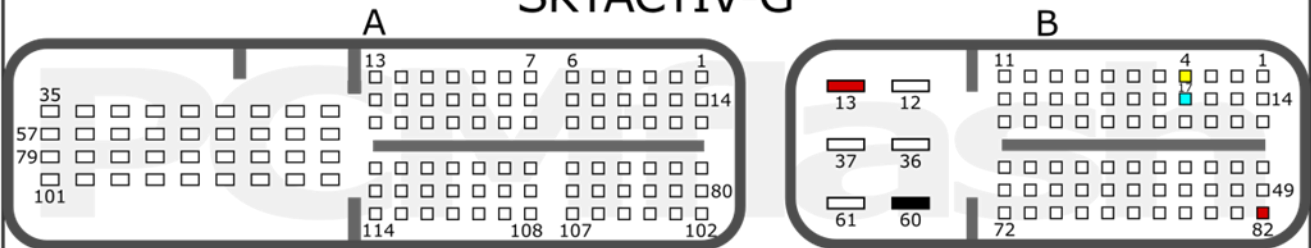

+12V	B: 13, 82	CAN-L	B: 17
GND	B: 60	CAN-H	B: 4

SKYACTIV-D

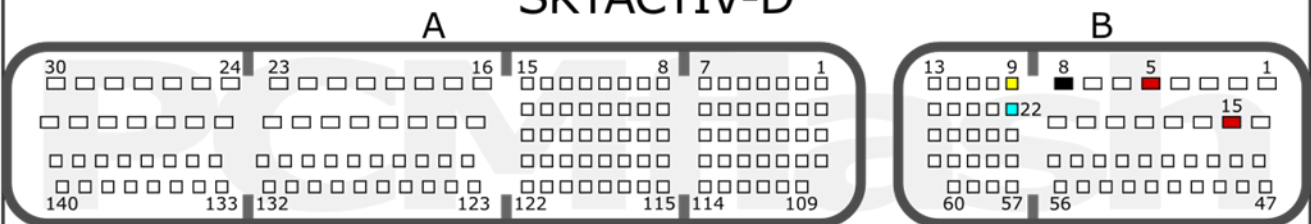

+12V	B: 5, 15	CAN-L	B: 22
GND	B: 8	CAN-H	B: 9

MAZDA GEN4

pcmflash.ru

v.1

2022-08-03

PCMflash

Electronic Control Unit
MAZDA TCM

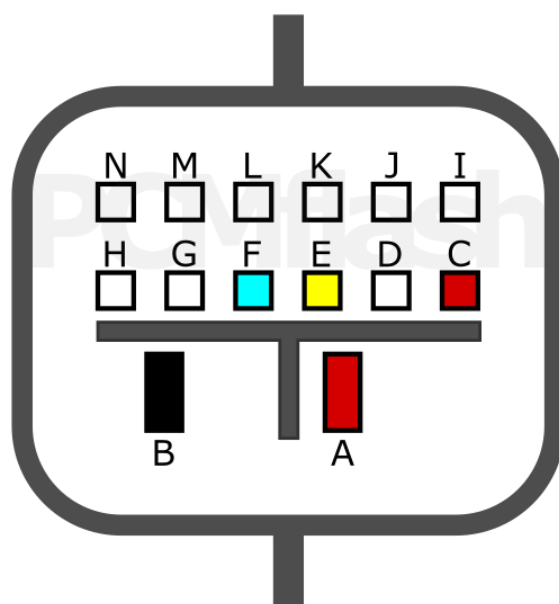

+12V	C, A	CAN-L	F
GND	B	CAN-H	E

MAZDA

PCMflash

Engine Control Unit

SH72543

A

B

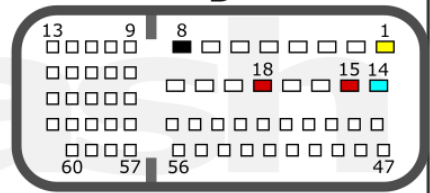
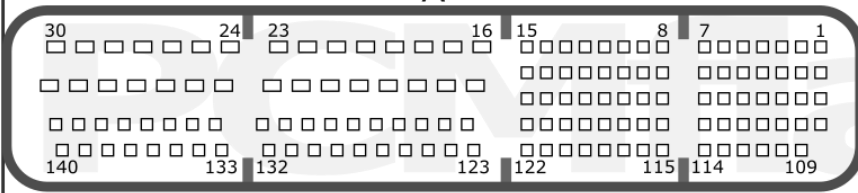

+12V	B: 15, 18	CAN-L	B: 14
GND	B: 8	CAN-H	B: 1

MITSUBISHI

SUBARU

pcmflash.ru

v.2

2022-11-02

PCMflash

Engine Control Unit

SH72530/SH72531

SH72531

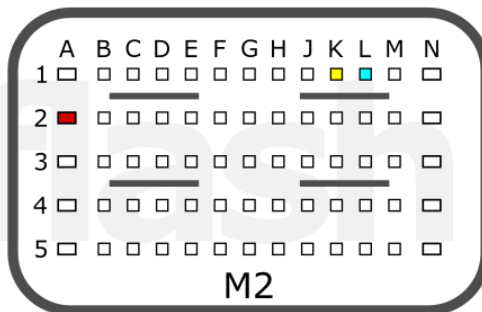
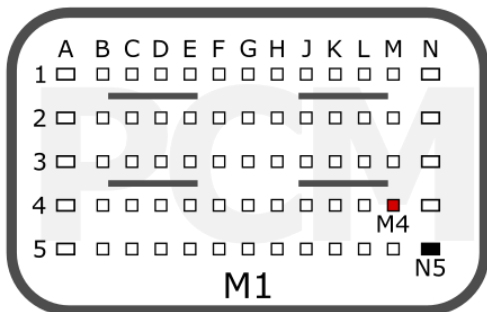

+12V	M1: M4, M2: A2	CAN-L	M2: L1
GND	M1: N5	CAN-H	M2: K1

T1 SH72530 + SH72531 T2

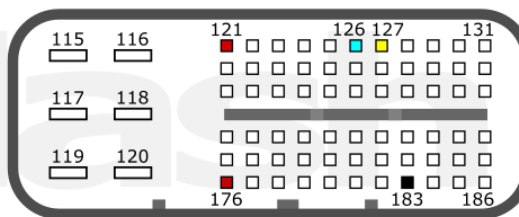
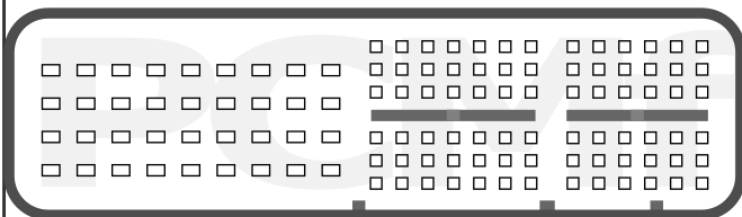

+12V	T2: 121, 176	CAN-L	T2: 126
GND	T2: 183	CAN-H	T2: 127

NISSAN

pcmflash.ru

v.3

2023-07-23

PCMflash

Engine Control Unit

SH72531

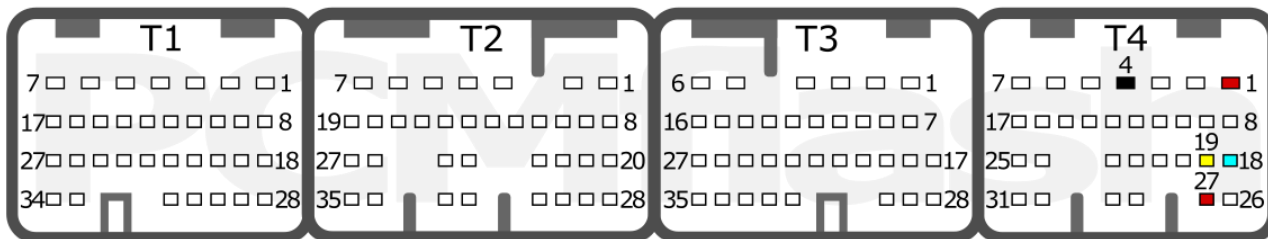

+12V	T4: 1, 27	CAN-L	T4: 18
GND	T4: 4	CAN-H	T4: 19

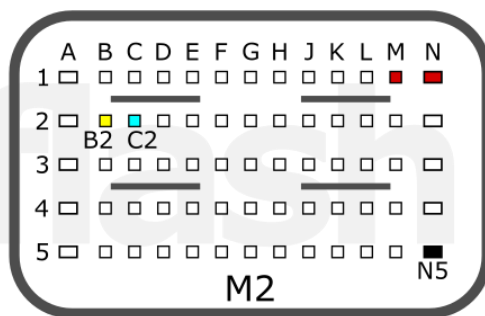
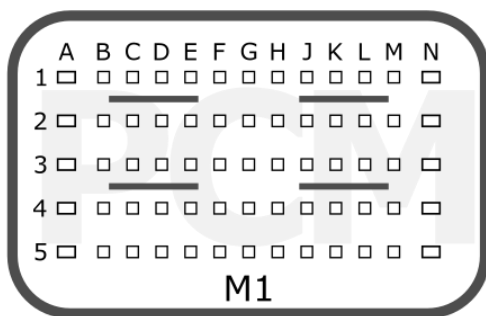

+12V	M2: M1, N1	CAN-L	M2: C2
GND	M2: N5	CAN-H	M2: B2

SUBARU

pcmflash.ru

v.1

2021-09-17

PCMflash

Engine Control Unit

1N83M

1.6L, 2.0L

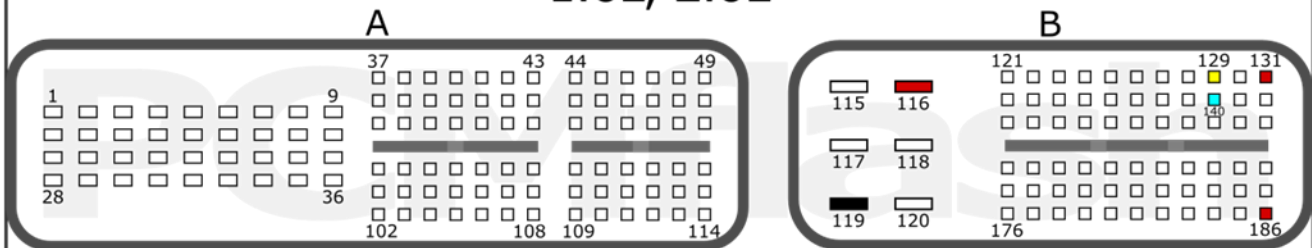

+12V	B: 116, 131, 186	CAN-L	B: 140
GND	B: 119	CAN-H	B: 129

2.5L

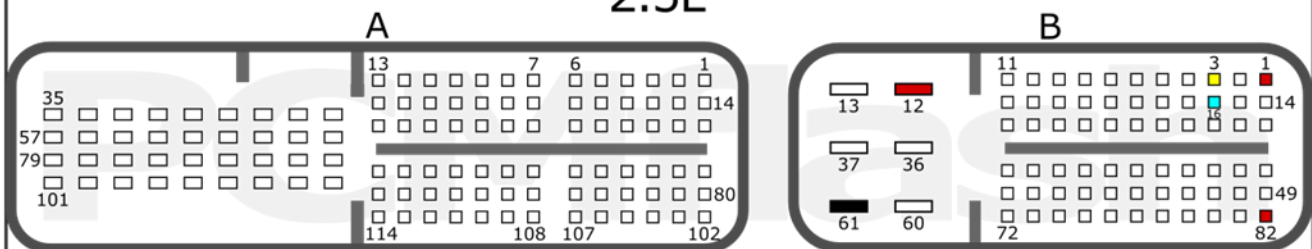

+12V	B: 1, 12	CAN-L	B: 16
GND	B: 61	CAN-H	B: 3

SUBARU 1.6L, 2.0L, 2.5L DI

pcmflash.ru

v.1

2022-08-03

PCMflash

Engine Control Unit

SH72530/SH72533

SH72530/SH72533

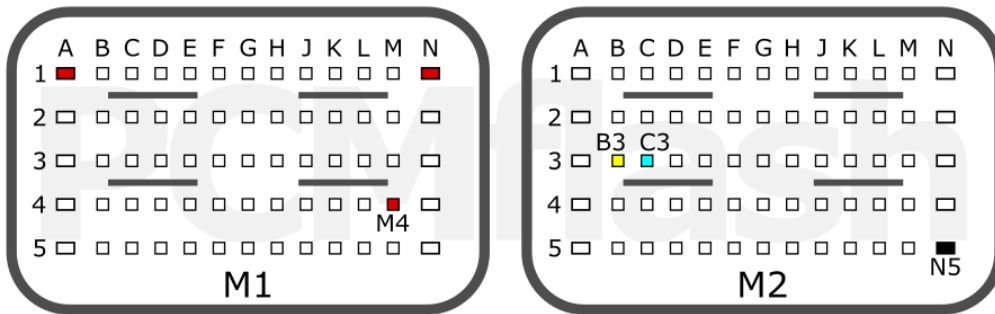

+12V	M1: A1, N1, M4	CAN-L	M2: C3
GND	M2: N5	CAN-H	M2: B3

SH72530

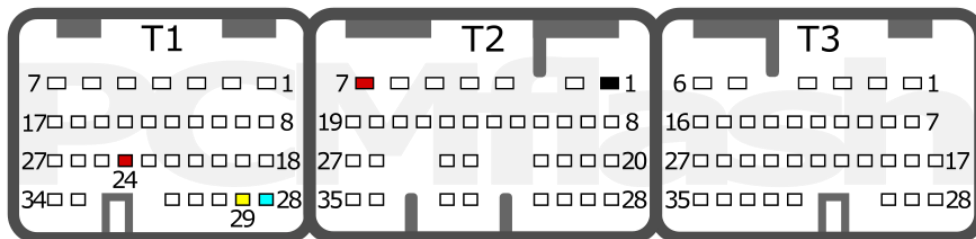

+12V	T1: 24; T2:7	CAN-L	T1: 28
GND	T2: 1	CAN-H	T1: 29

SUZUKI

pcmflash.ru

v.2

2023-01-30

PCMflash

Engine Control Unit

1N83M

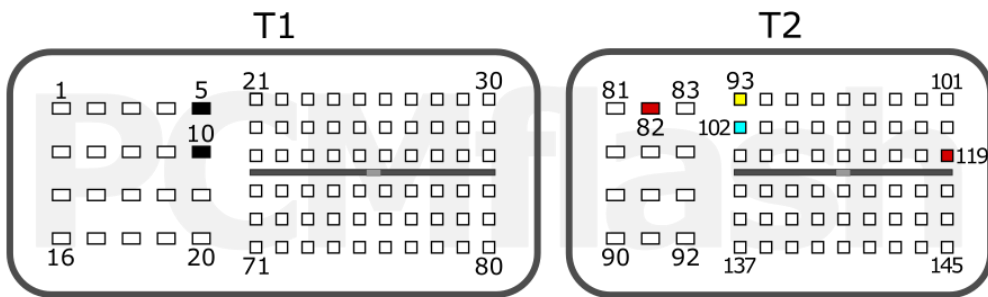

+12V	T2: 82, 119	CAN-L	T2: 102
GND	T1: 5, 10	CAN-H	T2: 93

SUZUKI

pcmflash.ru

v.1

2022-11-02

PCMflash

Engine Control Unit

SH7254x

SH72543

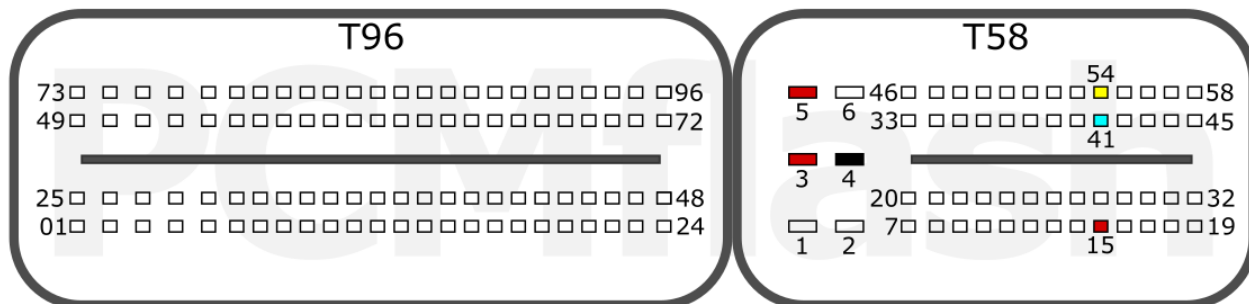

+12V	T58: 5, 3, 15	CAN-L	T58: 41
GND	T58: 4	CAN-H	T58: 54

SH72546

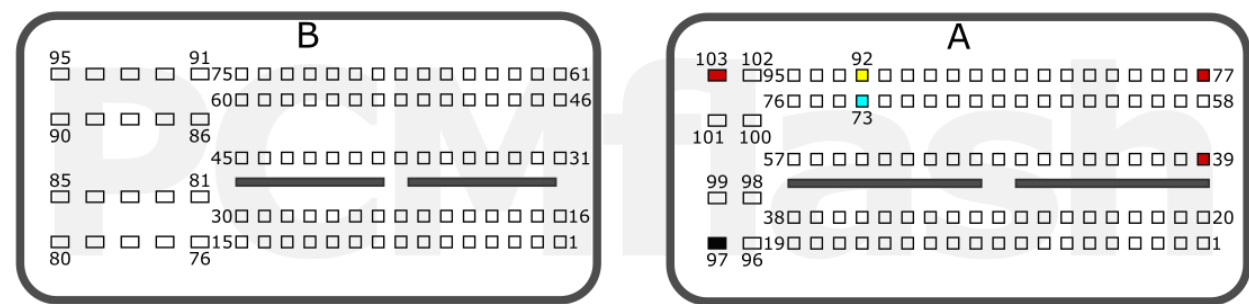

+12V	A: 103, 77, 39	CAN-L	A: 73
GND	A: 97	CAN-H	A: 92

VOLVO